

2SA1488/1488A

Silicon PNP Epitaxial Planar Transistor (Complement to type 2SC3851/A)

Application : Audio and General Purpose

Absolute maximum ratings (Ta=25°C)

Symbol	Ratings		Unit
	2SA1488	2SA1488A	
V _{CB0}	-60	-80	V
V _{CE0}	-60	-80	V
V _{EB0}	-6		V
I _c	-4		A
I _b	-1		A
P _c	25(T _c =25°C)		W
T _j	150		°C
T _{stg}	-55 to +150		°C

Electrical Characteristics

Symbol	Conditions	Ratings		Unit
		2SA1488	2SA1488A	
I _{CB0}	V _{CB} =	-100max	-100max	μA
I _{EB0}	V _{EB} =-6V	-60	-80	μA
V _{(BR)CEO}	I _c =-25mA	-60min	-80min	V
h _{FE}	V _{CE} =-4V, I _c =-1A	40min		
V _{CE(sat)}	I _c =-2A, I _b =-0.2A	-0.5max		V
f _T	V _{CE} =-12V, I _E =0.2A	15typ		MHz
C _{OB}	V _{CB} =-10V, f=1MHz	90typ		pF

External Dimensions FM20 (TO220F)

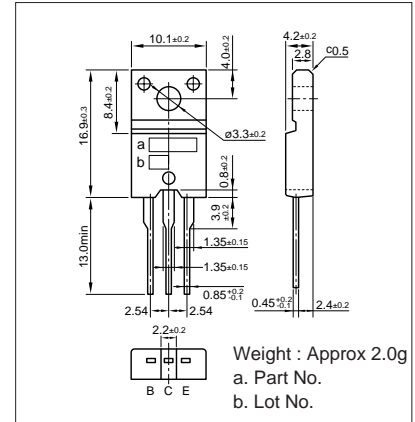

Typical Switching Characteristics (Common Emitter)

V _{CC} (V)	R _L (Ω)	I _c (A)	V _{BB1} (V)	V _{BB2} (V)	I _{b1} (mA)	I _{b2} (mA)	t _{on} (μs)	t _{stg} (μs)	t _f (μs)
-12	6	-2	-10	5	-200	200	0.25typ	0.75typ	0.25typ

I_c-V_{CE} Characteristics (Typical)

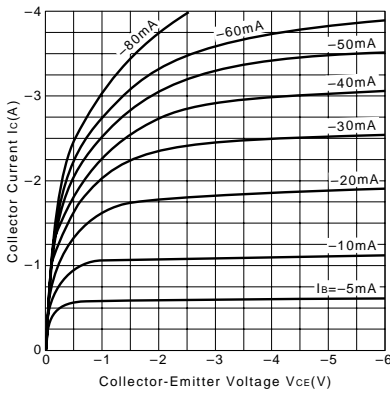

V_{CE(sat)}-I_b Characteristics (Typical)

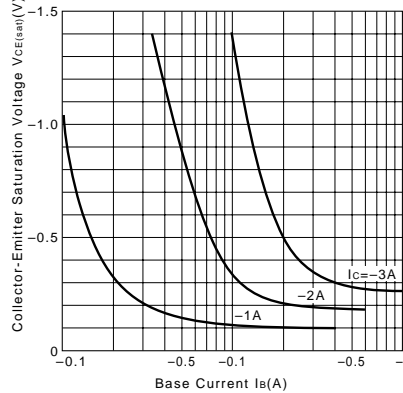

I_c-V_{BE} Temperature Characteristics (Typical)

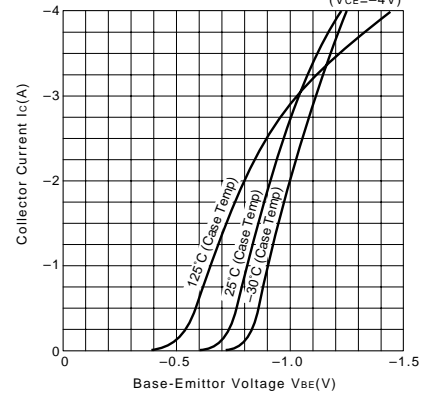

h_{FE}-I_c Characteristics (Typical)

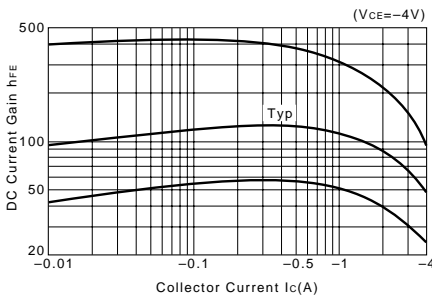

h_{FE}-I_c Temperature Characteristics (Typical)

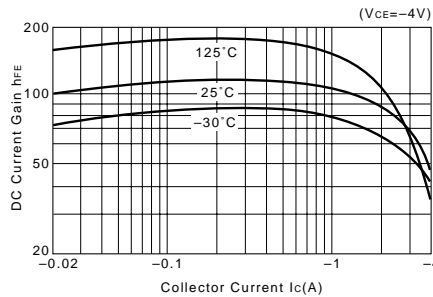

θ_{j-a}-t Characteristics

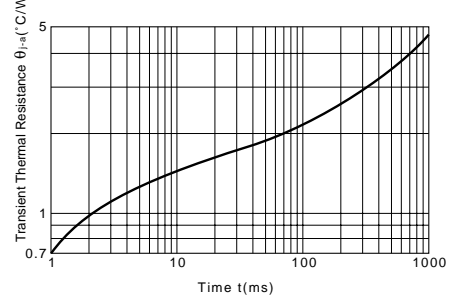

f_T-I_E Characteristics (Typical)

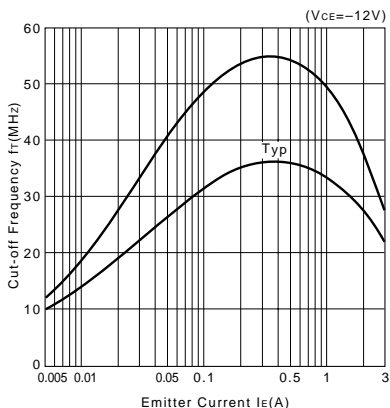

Safe Operating Area (Single Pulse)

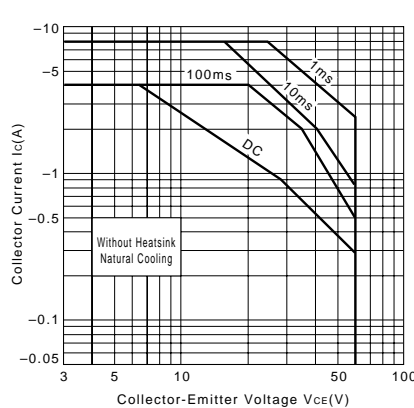

P_c-T_a Derating

