

2SB1025

SILICON PNP EPITAXIAL

LOW FREQUENCY POWER AMPLIFIER

Complementary pair with 2SD1418

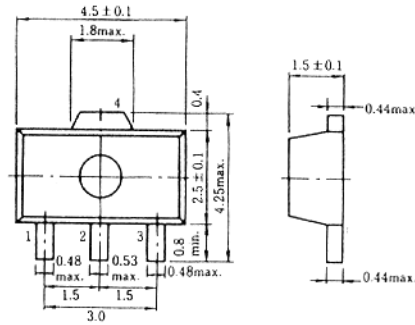

(UPAK)

1. Base
 2. Collector
 3. Emitter
 4. Collector (Flange)
- (Dimensions in mm)

■ ABSOLUTE MAXIMUM RATINGS (Ta=25°C)

Item	Symbol	2SB1025	Unit
Collector to base voltage	V _{CB0}	-120	V
Collector to emitter voltage	V _{CEO}	-80	V
Emitter to base voltage	V _{EBO}	-5	V
Collector current	I _C	-1	A
Collector peak current	i _{C(peak)} *	-2	A
Collector power dissipation	P _{C**}	1	W
Junction temperature	T _j	150	°C
Storage temperature	T _{stg}	-55 to +150	°C

* PW ≤ 10ms, Duty cycle ≤ 20%

** Value on the alumina ceramic board (12.5 × 20 × 0.7mm).

MAXIMUM COLLECTOR DISSIPATION CURVE

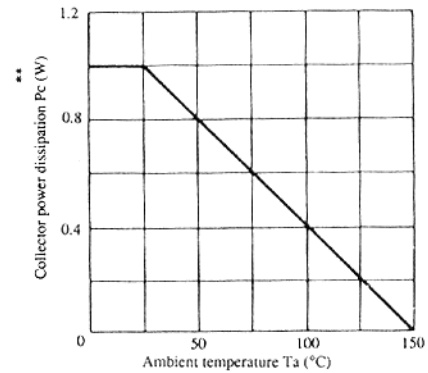

■ ELECTRICAL CHARACTERISTICS (Ta=25°C)

Item	Symbol	Test Condition	min.	typ.	max.	Unit
Collector to base breakdown voltage	V _{(BR)CBO}	I _C = -10μA, I _E = 0	-120	—	—	V
Collector to emitter breakdown voltage	V _{(BR)CEO}	I _C = -1mA, R _{BE} = ∞	-80	—	—	V
Emitter to base breakdown voltage	V _{(BR)EBO}	I _E = -10μA, I _C = 0	-5	—	—	V
Collector cutoff current	I _{CB0}	V _{CB} = -100V, I _E = 0	—	—	-10	μA
DC current transfer ratio	h _{FE1} *	V _{CE} = -5V, I _C = -150mA	60	—	320	
	h _{FE2}	V _{CE} = -5V, I _C = -500mA (Pulse test)	30	—	—	
Collector to emitter saturation voltage	V _{CE(sat)}	I _C = -500mA, I _B = -50mA, (Pulse test)	—	—	-1	V
Base to emitter voltage	V _{BE}	V _{CE} = -5V, I _C = -150mA	—	—	-0.9	V
Gain bandwidth product	f _T	V _{CE} = -5V, I _C = -150mA	—	140	—	MHz
Collector output capacitance	C _{ob}	V _{CB} = -10V, I _E = 0, f = 1MHz	—	20	—	pF

* The 2SB1025 is grouped by h_{FE1} as follows.

Mark	DH	DJ	DK
h _{FE1}	60 to 120	100 to 200	160 to 320

TYPICAL OUTPUT CHARACTERISTICS

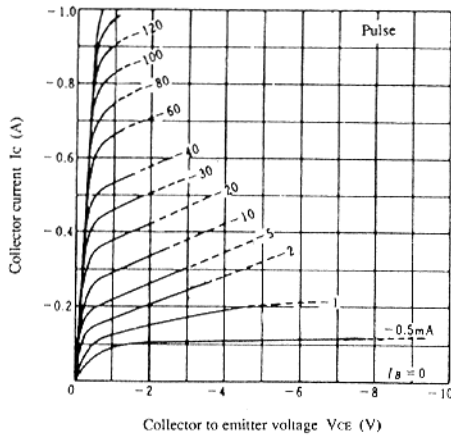

TYPICAL TRANSFER CHARACTERISTICS

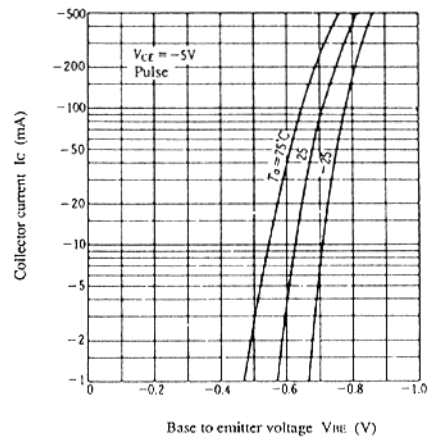

DC CURRENT TRANSFER RATIO VS. COLLECTOR CURRENT

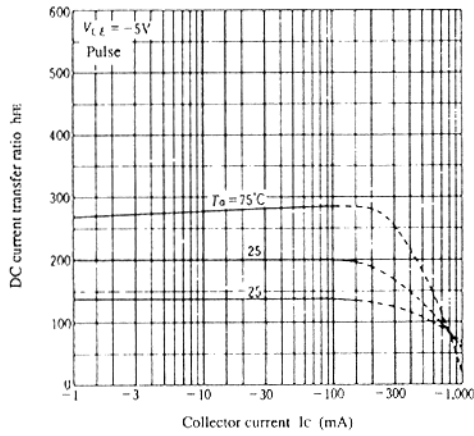

SATURATION VOLTAGE VS. COLLECTOR CURRENT

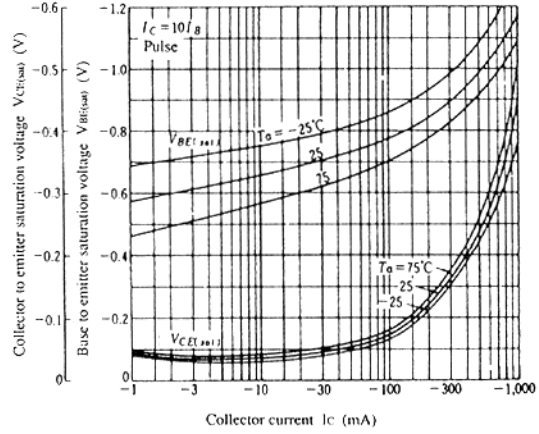

GAIN BANDWIDTH PRODUCT VS. COLLECTOR CURRENT

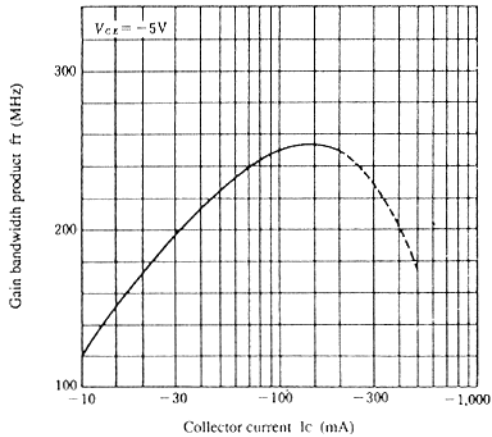

COLLECTOR OUTPUT CAPACITANCE VS. COLLECTOR TO BASE VOLTAGE

