

Medium power transistor(−80V, −0.7A)

2SB1189 / 2SB1238

●Features

- 1) High breakdown voltage, $V_{CE0}=-80V$, and high current, $I_c=-0.7A$.
- 2) Complements the 2SD1767 / 2SD1859.

●Absolute maximum ratings (Ta=25°C)

Parameter	Symbol	Limits	Unit		
Collector-base voltage	V_{CBO}	-80	V		
Collector-emitter voltage	V_{CEO}	-80	V		
Emitter-base voltage	V_{EBO}	-5	V		
Collector current	I_c	-0.7	A		
Collector power dissipation	2SB1189	P_c	0.5	W	*1
			2		
		2SB1238	1		
Junction temperature	T_j	150	°C		
Storage temperature	T_{stg}	-55 to +150	°C		

*1 When mounted on a 40x40x0.7 mm ceramic board.

*2 Printed circuit board 1.7 mm thick, collector plating 1cm² or larger.

●Packaging specifications and hFE

Type	2SB1189	2SB1238
Package	MPT3	ATV
hFE	QR	QR
Marking	BD*	-
Code	T100	TV2
Basic ordering unit (pieces)	1000	2500

*Denotes hFE

●Dimensions (Unit : mm)

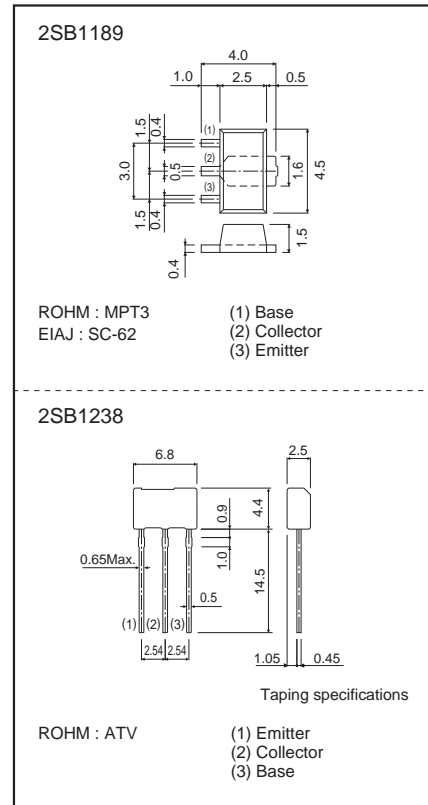

●Electrical characteristics (Ta=25°C)

Parameter	Symbol	Min.	Typ.	Max.	Unit	Conditions
Collector-base breakdown voltage	V_{CBO}	-80	-	-	V	$I_c=-50\mu A$
Collector-emitter breakdown voltage	V_{CEO}	-80	-	-	V	$I_c=-2mA$
Emitter-base breakdown voltage	V_{EBO}	-5	-	-	V	$I_E=-50\mu A$
Collector cutoff current	I_{CBO}	-	-	-0.5	μA	$V_{CB}=-50V$
Emitter cutoff current	I_{EBO}	-	-	-0.5	μA	$V_{EB}=-4V$
Collector-emitter saturation voltage	$V_{CE(sat)}$	-	-0.2	-0.4	V	$I_c/I_E=-500mA/-50mA$
DC current transfer ratio	h_{FE}	120	-	390	-	$V_{CE}/I_C=-3V/-0.1A$
Transition frequency	f_T	-	100	-	MHz	$V_{CE}=-10V, I_E=50mA, f=100MHz$
Output capacitance	C_{ob}	-	14	20	pF	$V_{CB}=-10V, I_E=0A, f=1MHz$

●Electrical characteristics curves

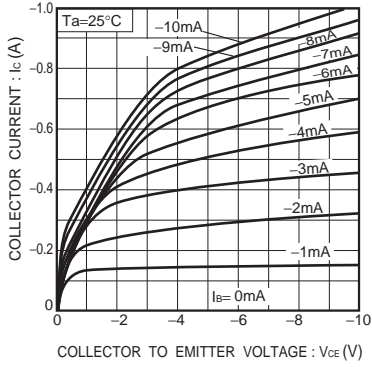

Fig.1 Ground emitter output characteristics

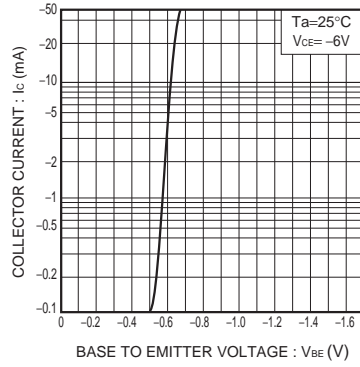

Fig.2 Ground emitter propagation characteristics

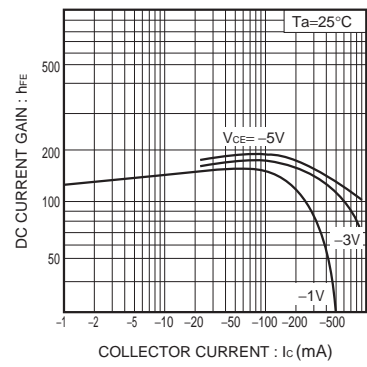

Fig.3 DC current gain vs. collector current

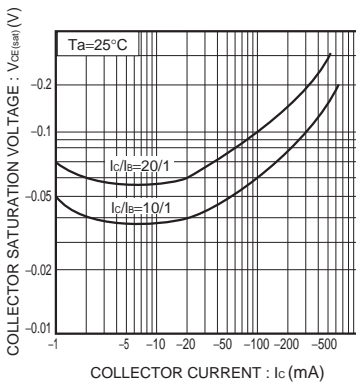

Fig.4 Collector-emitter saturation voltage vs. collector current

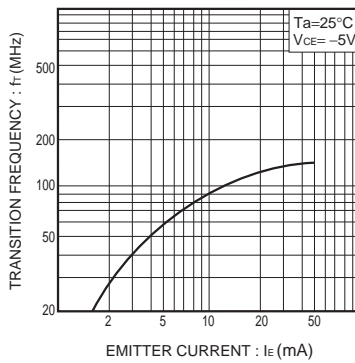

Fig.5 Gain bandwidth product vs. emitter current

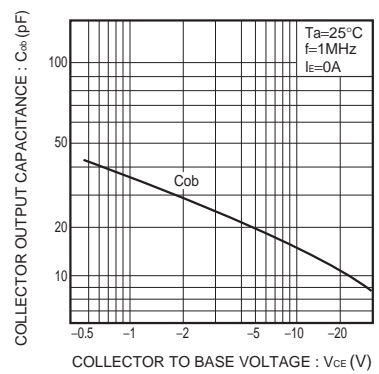

Fig.6 Collector output capacitance vs. collector-base voltage

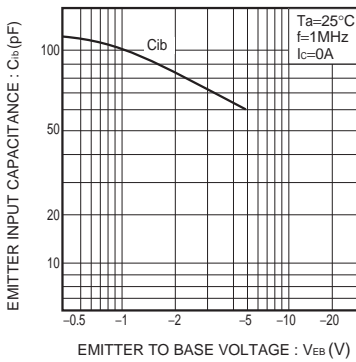

Fig.7 Emitter input capacitance vs. emitter-base voltage

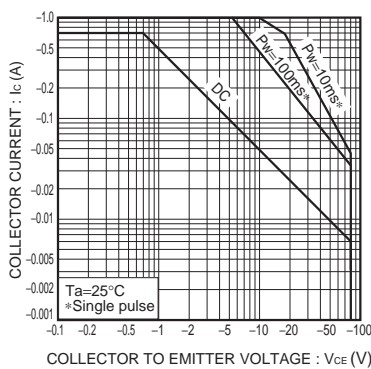

Fig.8 Safe operating area (2SB1189)

Notes

No copying or reproduction of this document, in part or in whole, is permitted without the consent of ROHM Co.,Ltd.

The content specified herein is subject to change for improvement without notice.

The content specified herein is for the purpose of introducing ROHM's products (hereinafter "Products"). If you wish to use any such Product, please be sure to refer to the specifications, which can be obtained from ROHM upon request.

Examples of application circuits, circuit constants and any other information contained herein illustrate the standard usage and operations of the Products. The peripheral conditions must be taken into account when designing circuits for mass production.

Great care was taken in ensuring the accuracy of the information specified in this document. However, should you incur any damage arising from any inaccuracy or misprint of such information, ROHM shall bear no responsibility for such damage.

The technical information specified herein is intended only to show the typical functions of and examples of application circuits for the Products. ROHM does not grant you, explicitly or implicitly, any license to use or exercise intellectual property or other rights held by ROHM and other parties. ROHM shall bear no responsibility whatsoever for any dispute arising from the use of such technical information.

The Products specified in this document are intended to be used with general-use electronic equipment or devices (such as audio visual equipment, office-automation equipment, communication devices, electronic appliances and amusement devices).

The Products specified in this document are not designed to be radiation tolerant.

While ROHM always makes efforts to enhance the quality and reliability of its Products, a Product may fail or malfunction for a variety of reasons.

Please be sure to implement in your equipment using the Products safety measures to guard against the possibility of physical injury, fire or any other damage caused in the event of the failure of any Product, such as derating, redundancy, fire control and fail-safe designs. ROHM shall bear no responsibility whatsoever for your use of any Product outside of the prescribed scope or not in accordance with the instruction manual.

The Products are not designed or manufactured to be used with any equipment, device or system which requires an extremely high level of reliability the failure or malfunction of which may result in a direct threat to human life or create a risk of human injury (such as a medical instrument, transportation equipment, aerospace machinery, nuclear-reactor controller, fuel-controller or other safety device). ROHM shall bear no responsibility in any way for use of any of the Products for the above special purposes. If a Product is intended to be used for any such special purpose, please contact a ROHM sales representative before purchasing.

If you intend to export or ship overseas any Product or technology specified herein that may be controlled under the Foreign Exchange and the Foreign Trade Law, you will be required to obtain a license or permit under the Law.



Thank you for your accessing to ROHM product informations.
More detail product informations and catalogs are available, please contact us.

ROHM Customer Support System

<http://www.rohm.com/contact/>