



2SD965/A

NPN SILICON TRANSISTOR

LOW VOLTAGE HIGH CURRENT TRANSISTOR

■ FEATURES

- * Collector current up to 5A
- * UTC **2SD965**: Collector-Emitter voltage up to 20 V
- * UTC **2SD965A**: Collector-Emitter voltage up to 30 V

■ APPLICATIONS

- * Audio amplifier
- * Flash unit of camera
- * Switching circuit

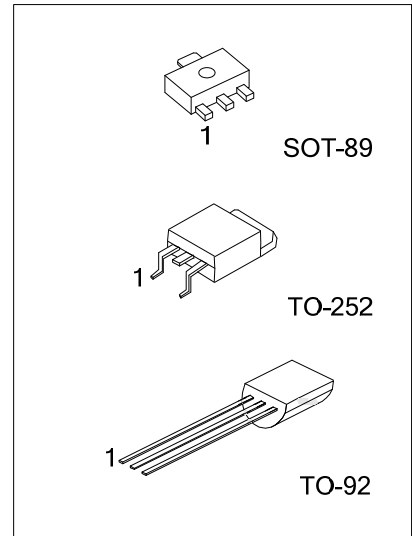

■ ORDERING INFORMATION

| Ordering Number | | Package | Pin Assignment | | | Packing |
|------------------|------------------|---------|----------------|---|---|-----------|
| Lead Free | Halogen Free | | 1 | 2 | 3 | |
| - | 2SD965G-x-AB3-R | SOT-89 | B | C | E | Tape Reel |
| 2SD965L-x-T92-B | 2SD965G-x-T92-B | TO-92 | E | C | B | Tape Box |
| 2SD965L-x-T92-K | 2SD965G-x-T92-K | TO-92 | E | C | B | Bulk |
| 2SD965L-x-TN3-R | 2SD965G-x-TN3-R | TO-252 | B | C | E | Tape Reel |
| - | 2SD965AG-x-AB3-R | SOT-89 | B | C | E | Tape Reel |
| 2SD965AL-x-T92-B | 2SD965AG-x-T92-B | TO-92 | E | C | B | Tape Box |
| 2SD965AL-x-T92-K | 2SD965AG-x-T92-K | TO-92 | E | C | B | Bulk |
| 2SD965AL-x-TN3-R | 2SD965AG-x-TN3-R | TO-252 | B | C | E | Tape Reel |

Note: Pin Assignment: C: Collector B: Base E: Emitter

| | |
|--|---|
| <p>2SD965G-x-AB3-R</p> <p>(1) Packing Type (2) Package Type (3) Rank (4) Green Package</p> | <p>(1) R: Tape Reel, B: Tape Box, K: Bulk (2) AB3: SOT-89, T92: TO-92, TN3: TO-252 (3) x: refer to Classification of h_{FE2} (4) G: Halogen Free and Lead Free, L: Lead Free</p> |
|--|---|

MARKING

| PACKAGE | MARKING | |
|---------|---------|---------|
| | 2SD965 | 2SD965A |
| SOT-89 | | |
| TO-252 | | |
| TO-92 | | |

■ ABSOLUTE MAXIMUM RATING (T_A=25°C)

| PARAMETER | SYMBOL | RATINGS | UNIT |
|---------------------------|------------------|------------|------|
| Collector-Base Voltage | V _{CBO} | 40 | V |
| Collector-Emitter Voltage | V _{CEO} | 20 | V |
| | | 30 | V |
| Emitter-Base Voltage | V _{EBO} | 7 | V |
| Collector Dissipation | P _C | 500 | mW |
| | | 750 | mW |
| | | 1 | W |
| Collector Current | I _C | 5 | A |
| Junction Temperature | T _J | 150 | °C |
| Storage Temperature | T _{STG} | -65 ~ +150 | °C |

Note: Absolute maximum ratings are those values beyond which the device could be permanently damaged. Absolute maximum ratings are stress ratings only and functional device operation is not implied.

■ ELECTRICAL CHARACTERISTICS (T_A=25°C, unless otherwise specified)

| PARAMETER | SYMBOL | TEST CONDITIONS | MIN | TYP | MAX | UNIT |
|--------------------------------------|----------------------|---|-----|-----|-----|------|
| Collector-Base Breakdown Voltage | BV _{CBO} | I _C =100μA, I _E =0 | 40 | | | V |
| Collector-Emitter Breakdown Voltage | BV _{CEO} | I _C =1mA, I _B =0 | 20 | | | V |
| | | | 30 | | | V |
| Emitter-Base Breakdown Voltage | BV _{EBO} | I _E =10μA, I _C =0 | 7 | | | V |
| Collector Cut-off Current | I _{CBO} | V _{CB} =10V, I _E =0 | | | 100 | nA |
| Emitter Cut-off Current | I _{EBO} | V _{EB} =7V, I _C =0 | | | 100 | nA |
| DC Current Gain | h _{FE1} | V _{CE} =2V, I _C =1mA | | 200 | | |
| | h _{FE2} | V _{CE} =2V, I _C =0.5A | 230 | | 800 | |
| | h _{FE3} | V _{CE} =2V, I _C =2A | 150 | | | |
| Collector-Emitter Saturation Voltage | V _{CE(SAT)} | I _C =3A, I _B =0.1A | | | 1 | V |
| Current Gain Bandwidth Product | f _T | V _{CE} =6V, I _C =50mA | | 150 | | MHz |
| Output Capacitance | C _{ob} | V _{CB} =20V, I _E =0, f=1MHz | | | 50 | pF |

■ CLASSIFICATION OF h_{FE2}

| RANK | Q | R | S |
|-------|---------|---------|---------|
| RANGE | 230-380 | 340-600 | 560-800 |

TYPICAL CHARACTERISTICS

Static Characteristics

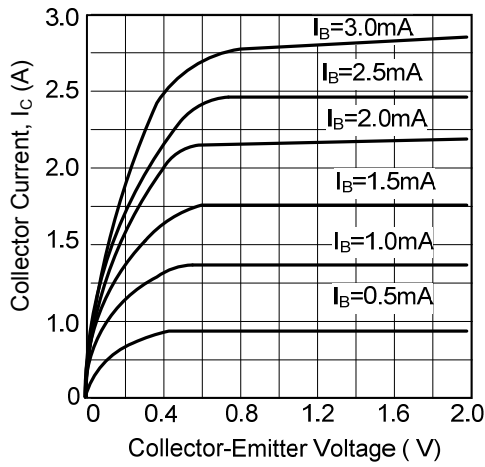

DC Current Gain

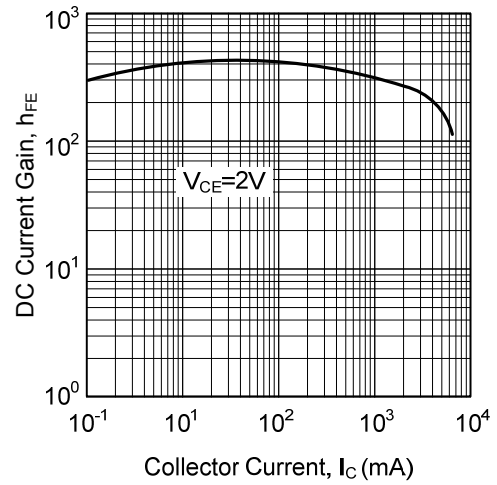

Base-Emitter on Voltage

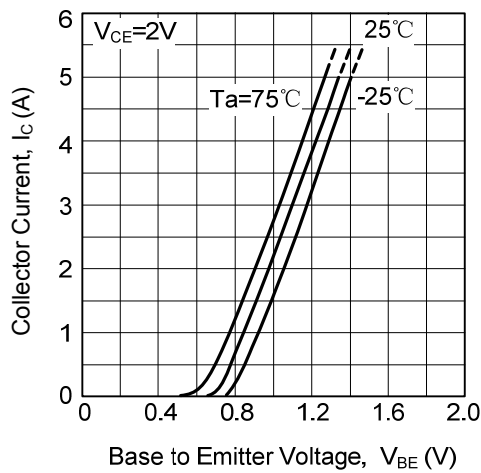

Saturation Voltage

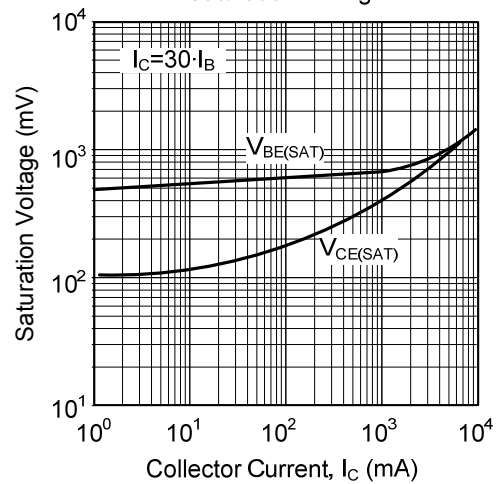

Current Gain-Bandwidth Product

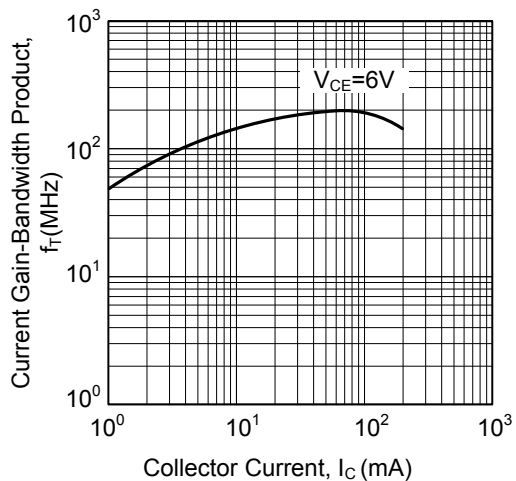

Collector Output Capacitance

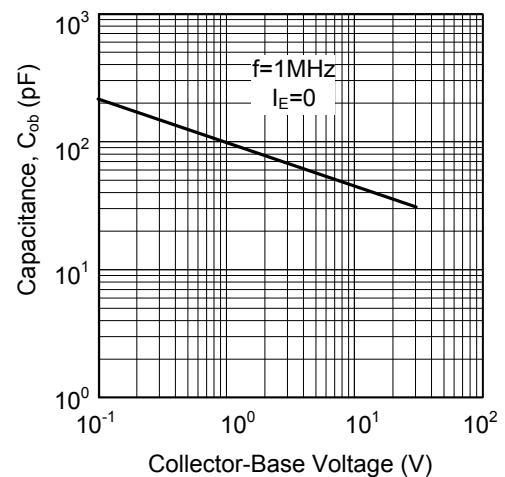

TYPICAL CHARACTERISTICS

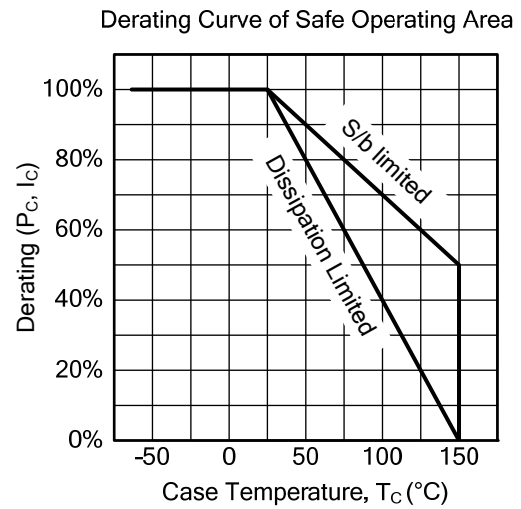
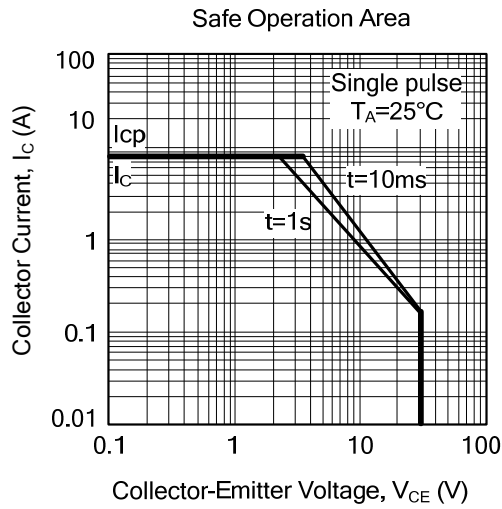

UTC assumes no responsibility for equipment failures that result from using products at values that exceed, even momentarily, rated values (such as maximum ratings, operating condition ranges, or other parameters) listed in products specifications of any and all UTC products described or contained herein. UTC products are not designed for use in life support appliances, devices or systems where malfunction of these products can be reasonably expected to result in personal injury. Reproduction in whole or in part is prohibited without the prior written consent of the copyright owner. The information presented in this document does not form part of any quotation or contract, is believed to be accurate and reliable and may be changed without notice.