



30L30CT
30L30CTS
30L30CT-1

SCHOTTKY RECTIFIER

30 Amp





Major Ratings and Characteristics

Characteristics	Values	Units
$I_{F(AV)}$ Rectangular waveform	2 x 15	A
V_{RRM}	30	V
V_F @ 15 Apk, $T_J = 125^\circ\text{C}$ (Per Leg)	0.37	V
T_J range	-55 to 150	$^\circ\text{C}$

Description/ Features

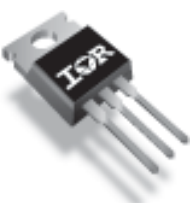
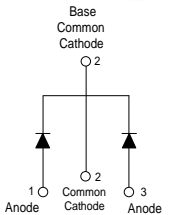
This center tap Schottky rectifier has been optimized for very low forward voltage drop, with moderate leakage. The proprietary barrier technology allows for reliable operation up to 150° C junction temperature. Typical applications are in switching power supplies, converters, free-wheeling diodes, and reverse battery protection.

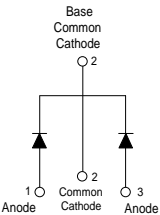
- 150° C T_J operation
- Center tap configuration
- Very low forward voltage drop
- High purity, high temperature epoxy encapsulation for enhanced mechanical strength and moisture resistance
- High frequency operation
- Guard ring for enhanced ruggedness and long term reliability

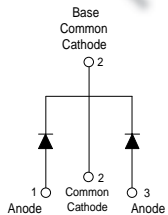
Case Styles		
<p>30L30CT</p>  <p>Base Common Cathode</p>  <p>TO-220</p>	<p>30L30CTS</p>  <p>Base Common Cathode</p>  <p>D²PAK</p>	<p>30L30CT -1</p>  <p>Base Common Cathode</p>  <p>TO-262</p>

Voltage Ratings

Parameters	30L30CT 30L30CTS 30L30CT-1
V_R Max. DC Reverse Voltage (V)	30
V_{RWM} Max. Working Peak Reverse Voltage (V)	

Absolute Maximum Ratings

Parameters	Values	Units	Conditions
$I_{F(AV)}$ Max. Average Forward Current Per Device Per Leg	30 15	A	50% duty cycle @ $T_C = 140^\circ\text{C}$, rectangular wave form
I_{FSM} Max. Peak One Cycle Non-Repetitive Surge Current	1450 220	A	5 μs Sine or 3 μs Rect. pulse 10ms Sine or 6ms Rect. pulse Following any rated load condition and with rated V_{RWM} applied
E_{AS} Non-Repetitive Avalanche Energy (Per Leg)	15	mJ	$T_J = 25^\circ\text{C}$, $I_{AS} = 2\text{Amps}$, $L = 7.5\text{mH}$
I_{AR} Repetitive Avalanche Current (Per Leg)	2	A	Current decaying linearly to zero in 1 μsec Frequency limited by T_J max. $V_A = 1.5 \times V_R$ typical

Electrical Specifications

Parameters	Values	Units	Conditions
V_{FM} Max. Forward Voltage Drop (Per Leg) (1)	0.46	V	@ 15A
	0.57	V	@ 30A
	0.37	V	@ 15A
	0.50	V	@ 30A
I_{RM} Max. Reverse Leakage Current (Per Leg)	1.50	mA	$T_J = 25^\circ\text{C}$
	350	mA	$T_J = 125^\circ\text{C}$
C_T Max. Junction Capacitance (Per Leg)	1500	pF	$V_R = 5V_{DC}$ (test signal range 100Khz to 1Mhz) 25°C
L_S Typical Series Inductance (Per Leg)	8.0	nH	Measured lead to lead 5mm from package body
dv/dt Max. Voltage Rate of Change	10000	V/ μs	(Rated V_R)

(1) Pulse Width < 300 μs , Duty Cycle <2%

Thermal-Mechanical Specifications

Parameters	Values	Units	Conditions
T_J Max. Junction Temperature Range	-55 to 150	$^\circ\text{C}$	
T_{stg} Max. Storage Temperature Range	-55 to 150	$^\circ\text{C}$	
R_{thJC} Max. Thermal Resistance Junction to Case (Per Leg)	1.5	$^\circ\text{C}/\text{W}$	DC operation
R_{thJC} Max. Thermal Resistance Junction to Case (Per Package)	0.8	$^\circ\text{C}/\text{W}$	DC operation
wt Approximate Weight	2 (0.07)	g (oz.)	
T Mounting Torque	Min.	6 (5)	Kg-cm (lbf-in)
	Max.	12 (10)	

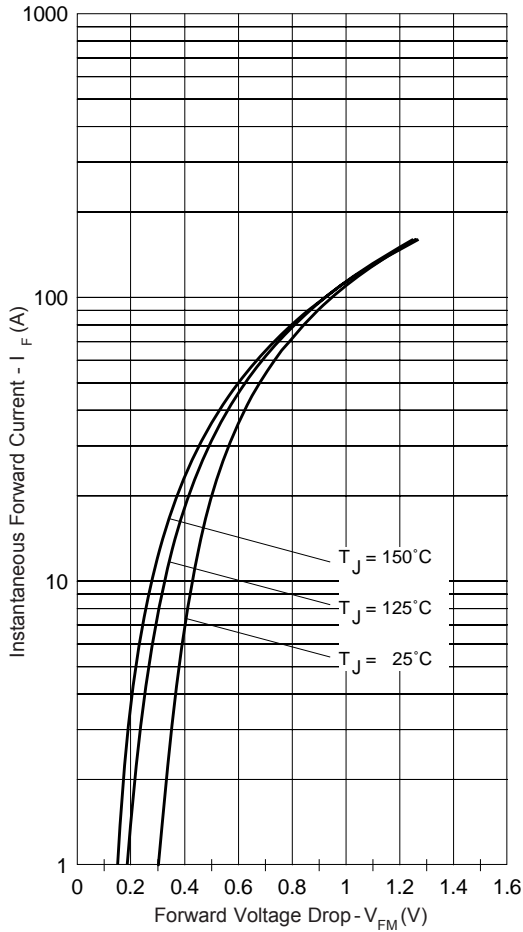

Fig. 1 - Maximum Forward Voltage Drop Characteristics

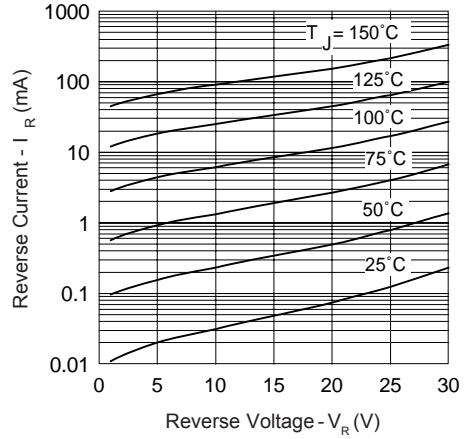

Fig. 2 - Typical Values of Reverse Current Vs. Reverse Voltage

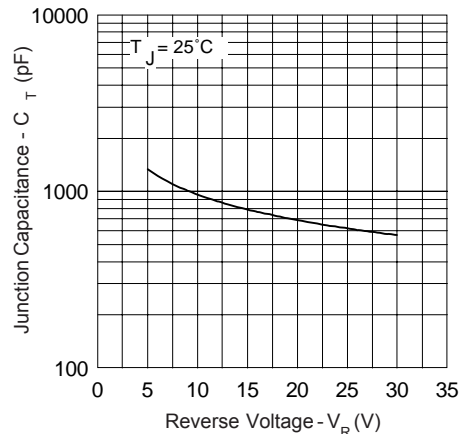

Fig. 3 - Typical Junction Capacitance Vs. Reverse Voltage

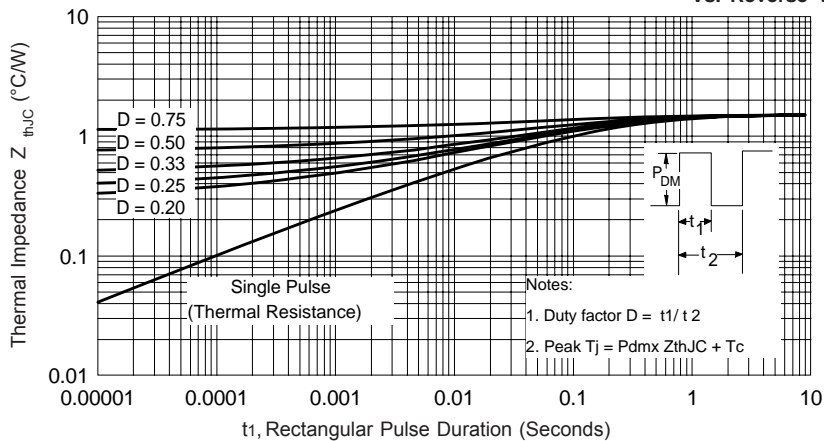

Fig. 4 - Max. Thermal Impedance Z_{thJC} Characteristics

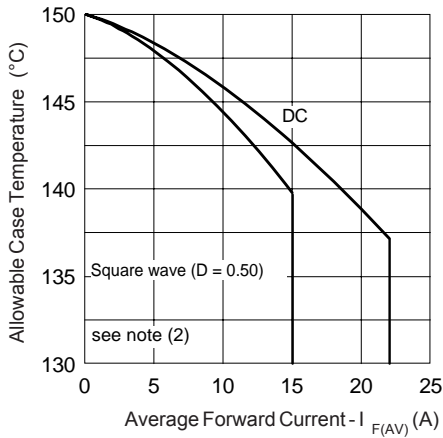

Fig. 5 - Max. Allowable Case Temperature Vs. Average Forward Current

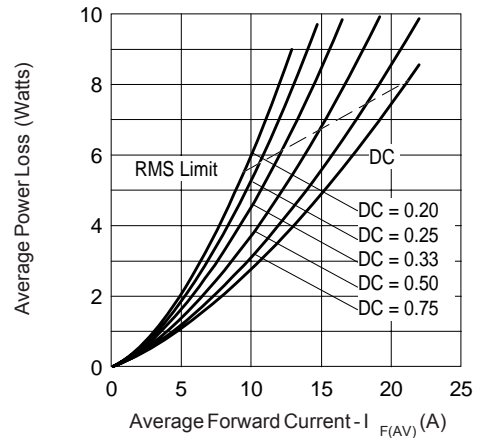

Fig. 6 - Forward Power Loss Characteristics

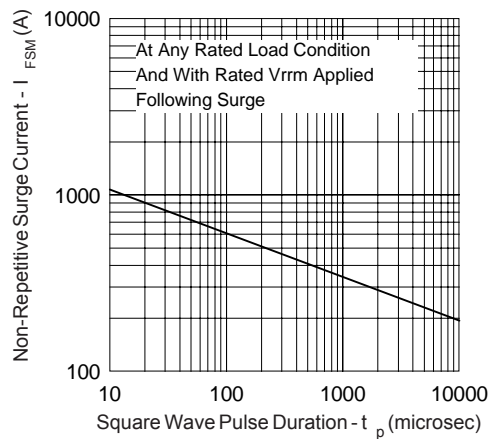
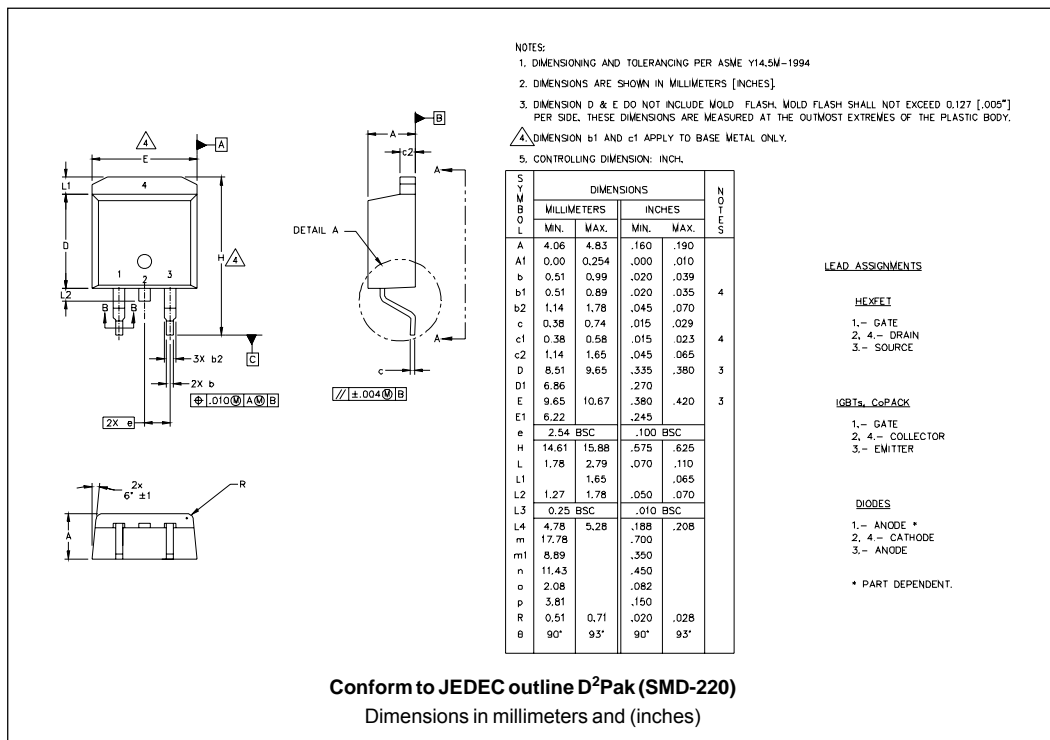
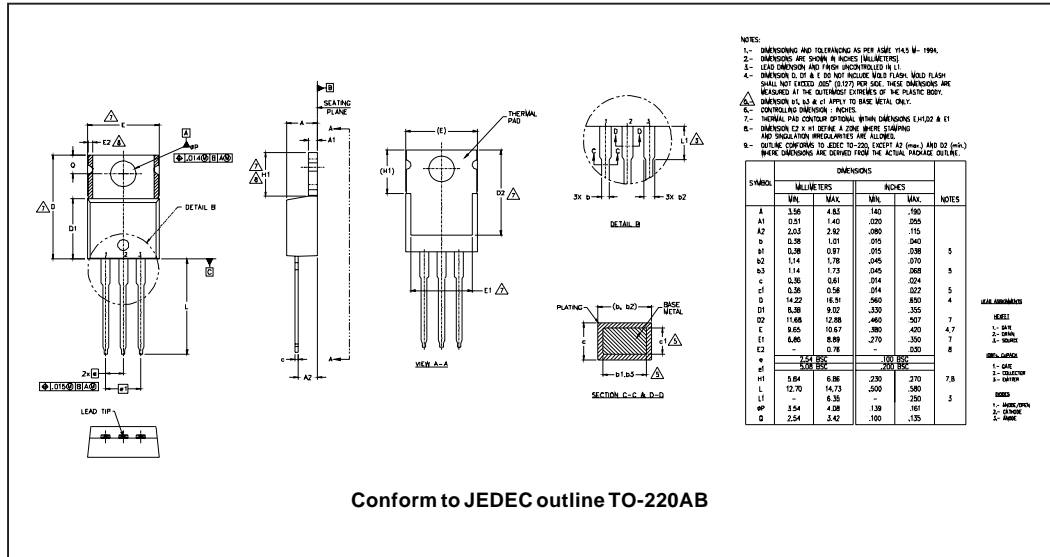

Fig. 7 - Max. Non-Repetitive Surge Current (Per Leg)

(2) Formula used: $T_c = T_j - P_d \times R_{thJC}$;

$P_d = \text{Forward Power Loss} = I_{F(AV)} \times V_{FM} @ (I_{F(AV)}/D)$ (see Fig. 6)

Outline Table



Outline Table

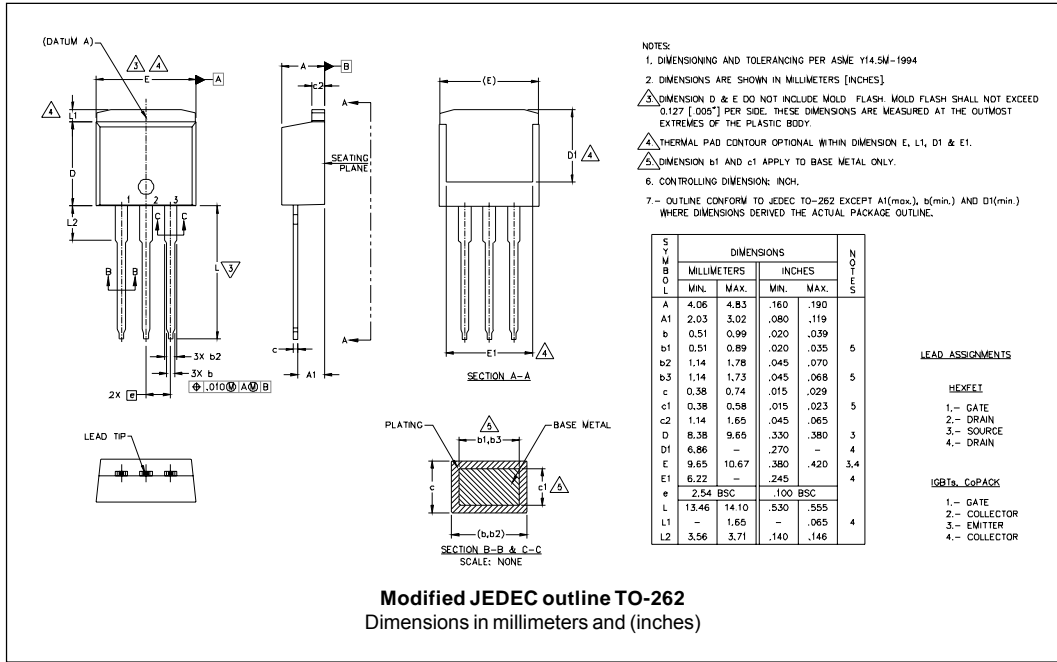

Tape & Reel Information

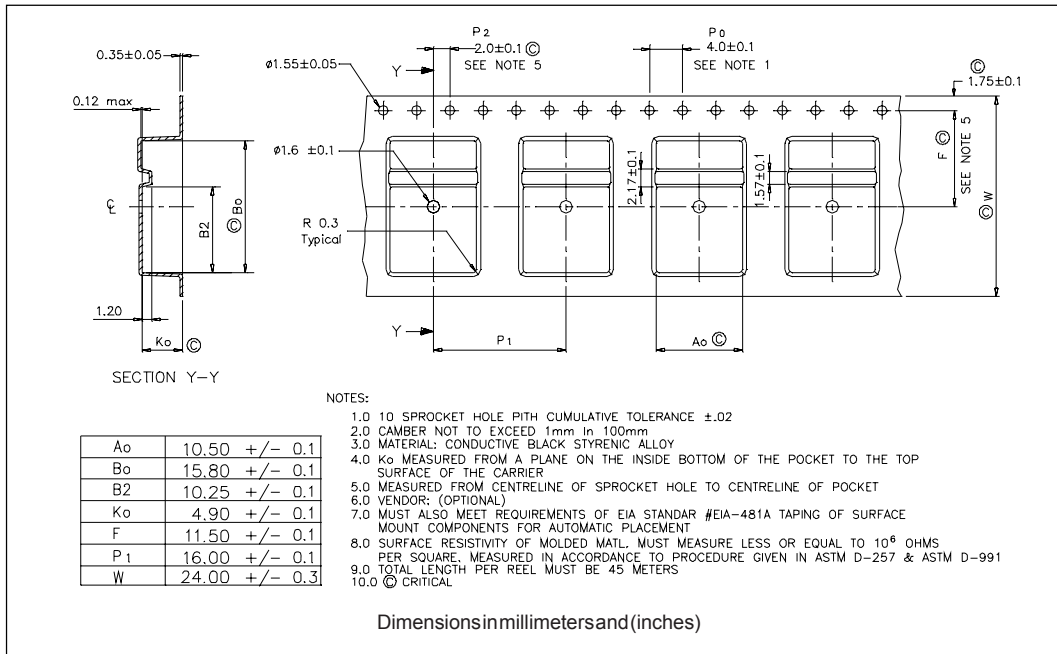

Part Marking Information

<p>TO-220</p>	<p>EXAMPLE: THIS IS A 30L30CT LOT CODE 1789 ASSEMBLED ON WW 19, 2000 IN THE ASSEMBLY LINE "C"</p>	<p>INTERNATIONAL RECTIFIER LOGO</p> <p>ASSEMBLY LOT CODE</p> <p>PART NUMBER</p> <p>DATE CODE</p> <p>YEAR 0 = 2000 WEEK 19 LINE C</p>
<p>D²PAK</p>	<p>EXAMPLE: THIS IS A 30L30CTS LOT CODE 8024 ASSEMBLED ON WW 02, 2003 IN ASSEMBLY LINE "C"</p>	<p>INTERNATIONAL RECTIFIER LOGO</p> <p>ASSEMBLY LOT CODE</p> <p>PART NUMBER</p> <p>DATE CODE</p> <p>YEAR 3 = 2003 WEEK 02 LINE C</p>
<p>TO-262</p>	<p>EXAMPLE: THIS IS A 30L30CT-1 LOT CODE 1789 ASSEMBLED ON WW 19, 2002 IN ASSEMBLY LINE "C"</p>	<p>INTERNATIONAL RECTIFIER LOGO</p> <p>ASSEMBLY LOT CODE</p> <p>PART NUMBER</p> <p>DATE CODE</p> <p>YEAR 2 = 2002 WEEK 19 LINE C</p>

```

30L30CT
*****
    This model has been developed by
    Wizard SPICE MODEL GENERATOR (1999)
    (International Rectifier Corporation)
    contains Proprietary Information
*****
    SPICE Model Diode is composed by a
    simple diode plus paralld VCG2T
*****
.SUBCKT 30l30ct ANO CAT
D1 ANO 1 DMOD (0.08936)
*Define diode model
.MODEL DMOD D(IS=3.01789428908089E-04A,N=1.12506549677918,BV=35V,
+ IBV=0.40837541124234A,RS= 0.000285952,CJO=3.65460570356249E-08,
+ VJ=0.934944724736772,XTI=2, EG=0.674450307828855)
*****
*Implementation of VCG2T
VX 1 2 DC 0V
R1 2 CAT TRES 1E-6
.MODEL TRES RES(R=1,TC1=11.2856367229303)
GP1 ANO CAT VALUE={-ABS(I(VX))*(EXP((( -2.138249E-03/11.28564)*((V(2,CAT)*1E6)/(I(VX)+1E-6)-
1))+1)*9.434315E-02*ABS(V(ANO,CAT)))-1}}
*****
.ENDS 30l30ct

Thermal Model Subcircuit
.SUBCKT 30L30CT 5 1

CTHERM1  5  4  3.53E-1
CTHERM2  4  3  6.35E0
CTHERM3  3  2  5.15E+1
CTHERM4  2  1  4.08E+3

R THERM1  5  4  3.15E-1
R THERM2  4  3  6.15E-1
R THERM1  3  2  3.7E-1
R THERM1  2  1  1.98E-1

.ENDS 30L30CT

```

Ordering Information Table

Device Code																	
	<table border="1" style="margin: auto;"> <tr> <td style="padding: 5px;">30</td> <td style="padding: 5px;">L</td> <td style="padding: 5px;">30</td> <td style="padding: 5px;">C</td> <td style="padding: 5px;">T</td> <td style="padding: 5px;">-1</td> <td style="padding: 5px;">TRL</td> <td style="padding: 5px;">-</td> </tr> <tr> <td style="text-align: center;">①</td> <td style="text-align: center;">②</td> <td style="text-align: center;">③</td> <td style="text-align: center;">④</td> <td style="text-align: center;">⑤</td> <td style="text-align: center;">⑥</td> <td style="text-align: center;">⑦</td> <td style="text-align: center;">⑧</td> </tr> </table>	30	L	30	C	T	-1	TRL	-	①	②	③	④	⑤	⑥	⑦	⑧
30	L	30	C	T	-1	TRL	-										
①	②	③	④	⑤	⑥	⑦	⑧										
1	- Current Rating (30A)																
2	- Schottky "L" Series																
3	- Voltage Rating (30 = 30V)																
4	- C = Common Cathode																
5	- T = TO-220																
6	- <ul style="list-style-type: none"> • S = D²Pak • -1 = TO-262 																
7	- <ul style="list-style-type: none"> • none = Tube (50 pieces) • TRL = Tape & Reel (Left Oriented - for D²Pak only) • TRR = Tape & Reel (Right Oriented - for D²Pak only) 																
8	- <ul style="list-style-type: none"> • none = Standard Production • PbF = Lead-Free 																

Data and specifications subject to change without notice.
 This product has been designed and qualified for Industrial Level.
 Qualification Standards can be found on IR's Web site.