

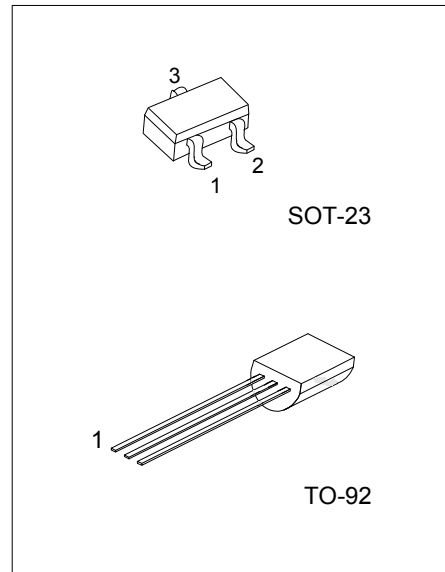

8550S

PNP SILICON TRANSISTOR

LOW VOLTAGE HIGH
CURRENT SMALL SIGNAL
PNP TRANSISTOR



■ DESCRIPTION

The UTC **8550S** is a low voltage high current small signal PNP transistor, designed for Class B push-pull audio amplifier and general purpose applications.

■ FEATURES

- *Collector current up to 700mA
- *Collector-Emitter voltage up to 20 V
- *Complimentary to 8050S

■ ORDERING INFORMATION

Ordering Number		Package	Pin Assignment			Packing
Lead Free	Halogen-Free		1	2	3	
8550SL-x-AE3-R	8550SG-x-AE3-R	SOT-23	B	E	C	Tape Reel
8550SL-x-T92-B	8550SG-x-T92-B	TO-92	E	C	B	Tape Box
8550SL-x-T92-K	8550SG-x-T92-K	TO-92	E	C	B	Bulk

Note: Pin Assignment: B: Base E: Emitter C: Collector

<p>8550SG-x-AE3-R</p>	<p>(1) R: Tape Reel, B: Tape Box, K: Bulk</p> <p>(2) AE3: SOT-23, T92: TO-92</p> <p>(3) x: refer to Classification of h_{FE2}</p> <p>(4) G: Halogen Free and Lead Free, L: Lead Free</p>
-----------------------	---

■ MARKING

SOT-23	TO-92

■ ABSOLUTE MAXIMUM RATINGS ($T_A=25^\circ\text{C}$, unless otherwise specified)

PARAMETER		SYMBOL	RATING	UNITS
Collector-Base Voltage		V_{CB0}	-30	V
Collector-Emitter Voltage		V_{CEO}	-20	V
Emitter-Base Voltage		V_{EBO}	-5	V
Collector Current		I_C	-700	mA
Collector Dissipation($T_a=25^\circ\text{C}$)	SOT-23	P_C	350	mW
	TO-92		1	W
Junction Temperature		T_J	+150	$^\circ\text{C}$
Storage Temperature		T_{STG}	-40 ~ +150	$^\circ\text{C}$

Note: Absolute maximum ratings are those values beyond which the device could be permanently damaged. Absolute maximum ratings are stress ratings only and functional device operation is not implied.

■ ELECTRICAL CHARACTERISTICS ($T_A=25^\circ\text{C}$, unless otherwise specified)

PARAMETER	SYMBOL	TEST CONDITIONS	MIN	TYP	MAX	UNIT
Collector-Base Breakdown Voltage	BV_{CB0}	$I_C=-100\mu\text{A}$, $I_E=0$	-30			V
Collector-Emitter Breakdown Voltage	BV_{CEO}	$I_C=-1\text{mA}$, $I_B=0$	-20			V
Emitter-Base Breakdown Voltage	BV_{EBO}	$I_E=-100\mu\text{A}$, $I_C=0$	-5			V
Collector Cut-off Current	I_{CBO}	$V_{CB}=-30\text{V}$, $I_E=0$			-1	μA
Emitter Cut-off Current	I_{EBO}	$V_{EB}=-5\text{V}$, $I_C=0$			-100	nA
DC Current Gain	h_{FE1}	$V_{CE}=-1\text{V}$, $I_C=-1\text{mA}$	100			
	h_{FE2}	$V_{CE}=-1\text{V}$, $I_C=-150\text{mA}$	120		400	
	h_{FE3}	$V_{CE}=-1\text{V}$, $I_C=-500\text{mA}$	40			
Collector-Emitter Saturation Voltage	$V_{CE(SAT)}$	$I_C=-500\text{mA}$, $I_B=-50\text{mA}$			-0.5	V
Base-Emitter Saturation Voltage	$V_{BE(SAT)}$	$I_C=-500\text{mA}$, $I_B=-50\text{mA}$			-1.2	V
Base-Emitter Saturation Voltage	V_{BE}	$V_{CE}=-1\text{V}$, $I_C=-10\text{mA}$			-1.0	V
Current Gain Bandwidth Product	f_T	$V_{CE}=-10\text{V}$, $I_C=-50\text{mA}$	100			MHz
Output Capacitance	C_{ob}	$V_{CB}=-10\text{V}$, $I_E=0$, $f=1\text{MHz}$		9.0		pF

■ CLASSIFICATION OF h_{FE2}

RANK	C	D	E
RANGE	120-200	160-300	280-400

■ TYPICAL CHARACTERISTICS

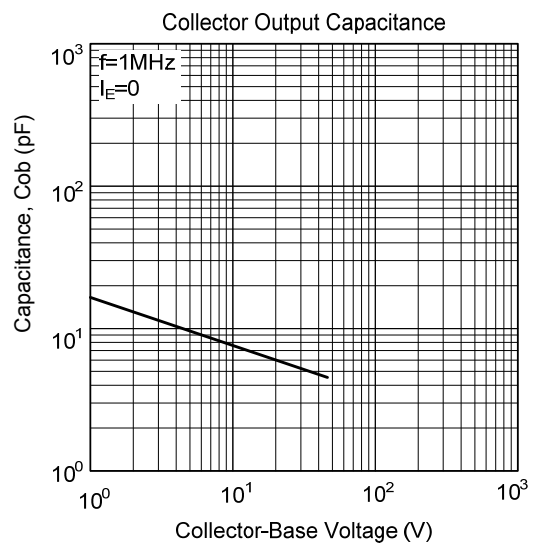
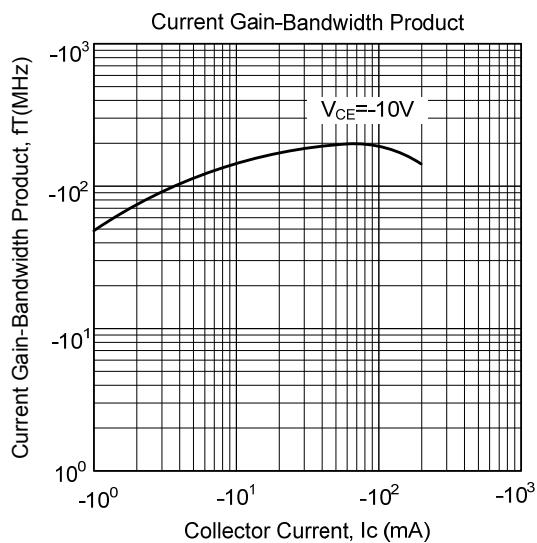
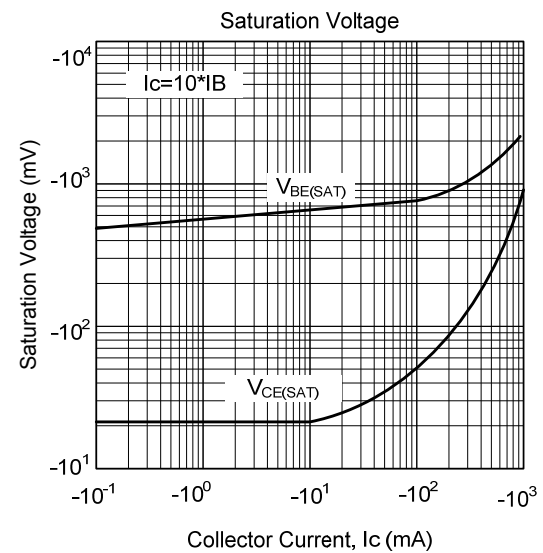
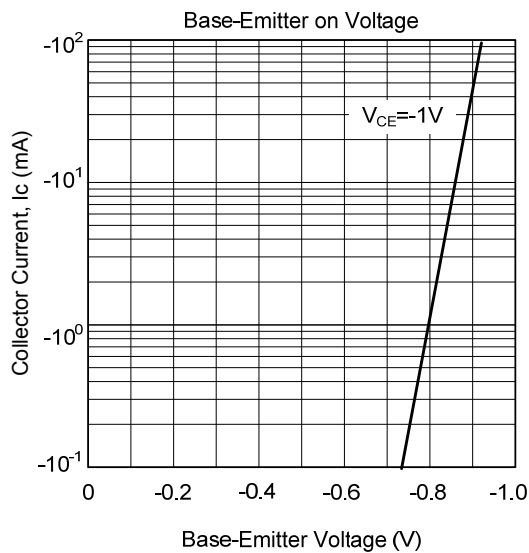
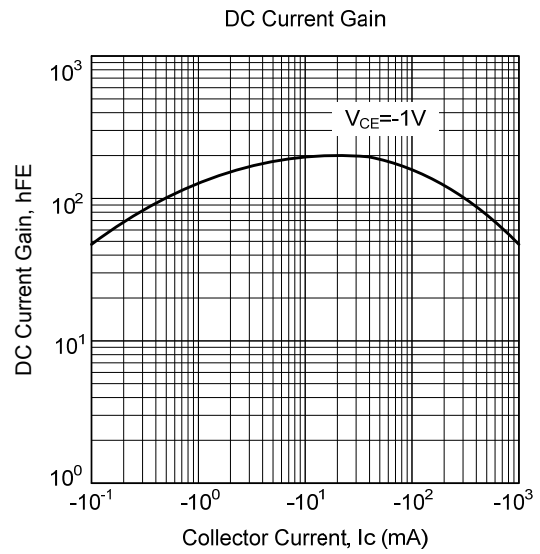
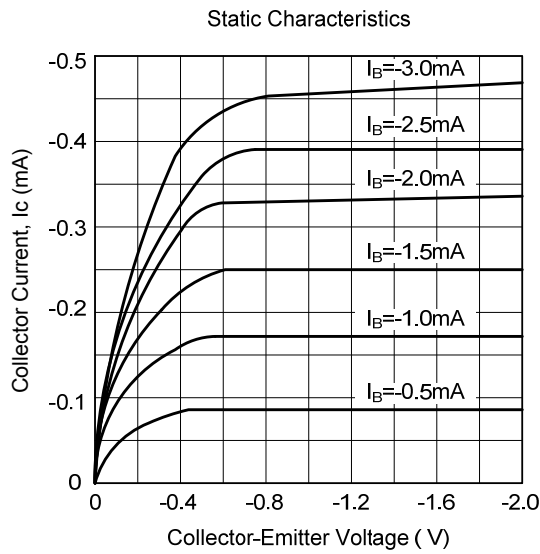

UTC assumes no responsibility for equipment failures that result from using products at values that exceed, even momentarily, rated values (such as maximum ratings, operating condition ranges, or other parameters) listed in products specifications of any and all UTC products described or contained herein. UTC products are not designed for use in life support appliances, devices or systems where malfunction of these products can be reasonably expected to result in personal injury. Reproduction in whole or in part is prohibited without the prior written consent of the copyright owner. UTC reserves the right to make changes to information published in this document, including without limitation specifications and product descriptions, at any time and without notice. This document supersedes and replaces all information supplied prior to the publication hereof.