

FEATURES

- True Single Supply Operation
- Output Swings Rail-to-Rail
- Input Voltage Range Extends Below Ground
- Single Supply Capability from 5 V to 36 V
- Dual Supply Capability from ± 2.5 V to ± 18 V
- Excellent Load Drive
 - Capacitive Load Drive Up to 350 pF
 - Minimum Output Current of 15 mA
- Excellent AC Performance for Low Power
 - 800 μ A Max Quiescent Current
 - Unity Gain Bandwidth: 1.8 MHz
 - Slew Rate of 3.0 V/ μ s
- Excellent DC Performance
 - 800 μ V Max Input Offset Voltage
 - 1 μ V/ $^{\circ}$ C Typ Offset Voltage Drift
 - 25 pA Max Input Bias Current
- Low Noise
 - 13 nV/ $\sqrt{\text{Hz}}$ @ 10 kHz

APPLICATIONS

- Battery-Powered Precision Instrumentation
- Photodiode Preamps
- Active Filters
- 12- to 14-Bit Data Acquisition Systems
- Medical Instrumentation
- Low Power References and Regulators

PRODUCT DESCRIPTION

The AD820 is a precision, low power FET input op amp that can operate from a single supply of 5.0 V to 36 V, or dual supplies of ± 2.5 V to ± 18 V. It has true single supply capability with an input voltage range extending below the negative rail,

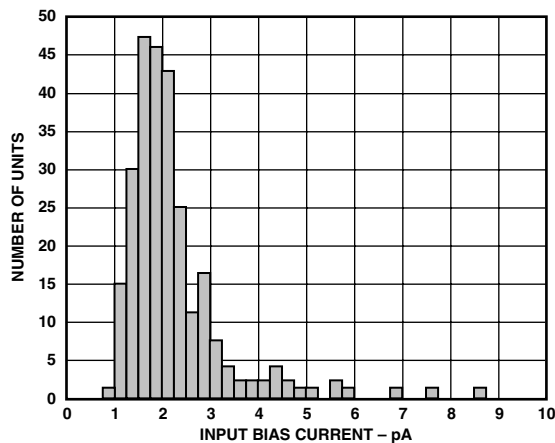
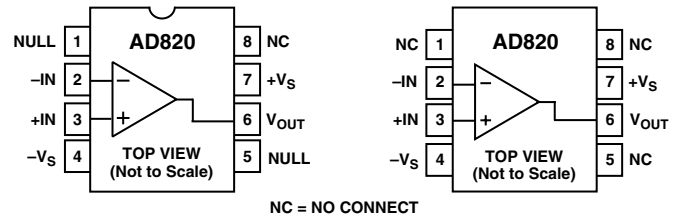

Figure 1. Typical Distribution of Input Bias Current

REV. D

Information furnished by Analog Devices is believed to be accurate and reliable. However, no responsibility is assumed by Analog Devices for its use, nor for any infringements of patents or other rights of third parties that may result from its use. No license is granted by implication or otherwise under any patent or patent rights of Analog Devices.

FUNCTIONAL BLOCK DIAGRAM



allowing the AD820 to accommodate input signals below ground in the single supply mode. Output voltage swing extends to within 10 mV of each rail providing the maximum output dynamic range.

Offset voltage of 800 μ V max, offset voltage drift of 1 μ V/ $^{\circ}$ C, typical input bias currents below 25 pA and low input voltage noise provide dc precision with source impedances up to a Gigaohm. 1.8 MHz unity gain bandwidth, -93 dB THD at 10 kHz and 3 V/ μ s slew rate are provided for a low supply current of 800 μ A. The AD820 drives up to 350 pF of direct capacitive load and provides a minimum output current of 15 mA. This allows the amplifier to handle a wide range of load conditions. This combination of ac and dc performance, plus the outstanding load drive capability, results in an exceptionally versatile amplifier for the single supply user.

The AD820 is available in two performance grades. The A and B grades are rated over the industrial temperature range of -40° C to $+85^{\circ}$ C.

The AD820 is offered in two varieties of 8-lead package: plastic DIP, and surface mount (SOIC).

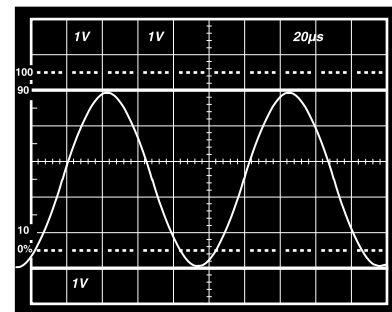

Figure 2. Gain of 2 Amplifier; $V_S = 5$, 0, $V_{IN} = 2.5$ V Sine Centered at 1.25 Volts

AD820—SPECIFICATIONS ($V_S = 0, 5\text{ V}$ @ $T_A = 25^\circ\text{C}$, $V_{CM} = 0\text{ V}$, $V_{OUT} = 0.2\text{ V}$ unless otherwise noted.)

Parameter	Conditions	AD820A			AD820B			Unit
		Min	Typ	Max	Min	Typ	Max	
DC PERFORMANCE								
Initial Offset			0.1	0.8		0.1	0.4	mV
Max Offset over Temperature			0.5	1.2		0.5	0.9	mV
Offset Drift			2			2		$\mu\text{V}/^\circ\text{C}$
Input Bias Current	$V_O = 0\text{ V to }4\text{ V}$		2	25		2	10	pA
at T_{MAX}			0.5	5		0.5	2.5	nA
Input Offset Current			2	20		2	10	pA
at T_{MAX}			0.5			0.5		nA
Open-Loop Gain	$V_O = 0.2\text{ V to }4\text{ V}$							V/mV
T_{MIN} to T_{MAX}	$R_L = 100\text{ k}\Omega$	400	1000		500	1000		V/mV
		400			400			V/mV
T_{MIN} to T_{MAX}	$R_L = 10\text{ k}\Omega$	80	150		80	150		V/mV
		80			80			V/mV
T_{MIN} to T_{MAX}	$R_L = 1\text{ k}\Omega$	15	30		15	30		V/mV
		10			10			V/mV
NOISE/HARMONIC PERFORMANCE								
Input Voltage Noise								$\mu\text{V p-p}$
0.1 Hz to 10 Hz			2			2		$\text{nV}/\sqrt{\text{Hz}}$
f = 10 Hz			25			25		$\text{nV}/\sqrt{\text{Hz}}$
f = 100 Hz			21			21		$\text{nV}/\sqrt{\text{Hz}}$
f = 1 kHz			16			16		$\text{nV}/\sqrt{\text{Hz}}$
f = 10 kHz			13			13		$\text{nV}/\sqrt{\text{Hz}}$
Input Current Noise								fA p-p
0.1 Hz to 10 Hz			18			18		$\text{fA}/\sqrt{\text{Hz}}$
f = 1 kHz			0.8			0.8		$\text{fA}/\sqrt{\text{Hz}}$
Harmonic Distortion	$R_L = 10\text{ k}\Omega$ to 2.5 V							dB
f = 10 kHz	$V_O = 0.25\text{ V to }4.75\text{ V}$		-93			-93		
DYNAMIC PERFORMANCE								
Unity Gain Frequency			1.8			1.8		MHz
Full Power Response	V_O p-p = 4.5 V		210			210		kHz
Slew Rate			3			3		V/ μs
Settling Time								μs
to 0.1%	$V_O = 0.2\text{ V to }4.5\text{ V}$		1.4			1.4		μs
to 0.01%			1.8			1.8		μs
INPUT CHARACTERISTICS								
Common-Mode Voltage Range ¹		-0.2		+4	-0.2		+4	V
T_{MIN} to T_{MAX}		-0.2		+4	-0.2		+4	V
CMRR	$V_{CM} = 0\text{ V to }2\text{ V}$	66	80		72	80		dB
T_{MIN} to T_{MAX}		66			66			dB
Input Impedance								Ω pF
Differential			10^{13} 0.5			10^{13} 0.5		Ω pF
Common Mode			10^{13} 2.8			10^{13} 2.8		Ω pF
OUTPUT CHARACTERISTICS								
Output Saturation Voltage ²								mV
$V_{OL}-V_{EE}$	$I_{SINK} = 20\text{ }\mu\text{A}$		5	7		5	7	mV
T_{MIN} to T_{MAX}				10			10	mV
$V_{CC}-V_{OH}$	$I_{SOURCE} = 20\text{ }\mu\text{A}$		10	14		10	14	mV
T_{MIN} to T_{MAX}				20			20	mV
$V_{OL}-V_{EE}$	$I_{SINK} = 2\text{ mA}$		40	55		40	55	mV
T_{MIN} to T_{MAX}				80			80	mV
$V_{CC}-V_{OH}$	$I_{SOURCE} = 2\text{ mA}$		80	110		80	110	mV
T_{MIN} to T_{MAX}				160			160	mV
$V_{OL}-V_{EE}$	$I_{SINK} = 15\text{ mA}$		300	500		300	500	mV
T_{MIN} to T_{MAX}				1000			1000	mV
$V_{CC}-V_{OH}$	$I_{SOURCE} = 15\text{ mA}$		800	1500		800	1500	mV
T_{MIN} to T_{MAX}				1900			1900	mV
Operating Output Current		15			15			mA
T_{MIN} to T_{MAX}		12			12			mA
Short-Circuit Current			25			25		mA
Capacitive Load Drive			350			350		pF
POWER SUPPLY								
Quiescent Current	T_{MIN} to T_{MAX}		620	800		620	800	μA
Power Supply Rejection	$V_{S+} = 5\text{ V to }15\text{ V}$	70	80		66	80		dB
T_{MIN} to T_{MAX}		70			66			dB

SPECIFICATIONS ($V_S = 0, 5\text{ V} @ T_A = 25^\circ\text{C}$, $V_{CM} = 0\text{ V}$, $V_{OUT} = 0.2\text{ V}$ unless otherwise noted.)

AD820

Parameter	Conditions	AD820A			AD820B			Unit
		Min	Typ	Max	Min	Typ	Max	
DC PERFORMANCE								
Initial Offset			0.1	0.8		0.3	0.4	mV
Max Offset over Temperature			0.5	1.5		0.5	1	mV
Offset Drift			2			2		$\mu\text{V}/^\circ\text{C}$
Input Bias Current at T_{MAX}	$V_O = -5\text{ V to }4\text{ V}$		2	25		2	10	pA
Input Offset Current at T_{MAX}			0.5	5		0.5	2.5	nA
Open-Loop Gain			2	20		2	10	pA
			0.5			0.5		nA
T_{MIN} to T_{MAX}	$V_O = 4\text{ V to }-4\text{ V}$ $R_L = 100\text{ k}\Omega$	400	1000		400	1000		V/mV
		400			400			V/mV
T_{MIN} to T_{MAX}	$R_L = 10\text{ k}\Omega$	80	150		80	150		V/mV
		80			80			V/mV
T_{MIN} to T_{MAX}	$R_L = 1\text{ k}\Omega$	20	30		20	30		V/mV
		10			10			V/mV
NOISE/HARMONIC PERFORMANCE								
Input Voltage Noise								
0.1 Hz to 10 Hz			2			2		$\mu\text{V p-p}$
$f = 10\text{ Hz}$			25			25		$\text{nV}/\sqrt{\text{Hz}}$
$f = 100\text{ Hz}$			21			21		$\text{nV}/\sqrt{\text{Hz}}$
$f = 1\text{ kHz}$			16			16		$\text{nV}/\sqrt{\text{Hz}}$
$f = 10\text{ kHz}$			13			13		$\text{nV}/\sqrt{\text{Hz}}$
Input Current Noise								
0.1 Hz to 10 Hz			18			18		fA p-p
$f = 1\text{ kHz}$			0.8			0.8		$\text{fA}/\sqrt{\text{Hz}}$
Harmonic Distortion	$R_L = 10\text{ k}\Omega$ $V_O = \pm 4.5\text{ V}$							
$f = 10\text{ kHz}$				-93			-93	dB
DYNAMIC PERFORMANCE								
Unity Gain Frequency			1.9			1.8		MHz
Full Power Response	$V_O\text{ p-p} = 9\text{ V}$		105			105		kHz
Slew Rate			3			3		V/ μs
Settling Time to 0.1%	$V_O = 0\text{ V to } \pm 4.5\text{ V}$		1.4			1.4		μs
to 0.01%			1.8			1.8		μs
INPUT CHARACTERISTICS								
Common-Mode Voltage Range ¹		-5.2		+4	-5.2		+4	V
T_{MIN} to T_{MAX}		-5.2		+4	-5.2		+4	V
CMRR	$V_{CM} = -5\text{ V to }+2\text{ V}$	66	80		72	80		dB
T_{MIN} to T_{MAX}		66			66			dB
Input Impedance								
Differential			$10^{13} 0.5$			$10^{13} 0.5$		ΩpF
Common Mode			$10^{13} 2.8$			$10^{13} 2.8$		ΩpF
OUTPUT CHARACTERISTICS								
Output Saturation Voltage ²								
$V_{OL}-V_{EE}$	$I_{SINK} = 20\text{ }\mu\text{A}$		5	7		5	7	mV
T_{MIN} to T_{MAX}				10			10	mV
$V_{CC}-V_{OH}$	$I_{SOURCE} = 20\text{ }\mu\text{A}$		10	14		10	14	mV
T_{MIN} to T_{MAX}				20			20	mV
$V_{OL}-V_{EE}$	$I_{SINK} = 2\text{ mA}$		40	55		40	55	mV
T_{MIN} to T_{MAX}				80			80	mV
$V_{CC}-V_{OH}$	$I_{SOURCE} = 2\text{ mA}$		80	110		80	110	mV
T_{MIN} to T_{MAX}				160			160	mV
$V_{OL}-V_{EE}$	$I_{SINK} = 15\text{ mA}$		300	500		300	500	mV
T_{MIN} to T_{MAX}				1000			1000	mV
$V_{CC}-V_{OH}$	$I_{SOURCE} = 15\text{ mA}$		800	1500		800	1500	mV
T_{MIN} to T_{MAX}				1900			1900	mV
Operating Output Current		15			15			mA
T_{MIN} to T_{MAX}		12			12			mA
Short-Circuit Current			30			30		mA
Capacitive Load Drive			350			350		pF
POWER SUPPLY								
Quiescent Current	T_{MIN} to T_{MAX}		650	800		620	800	μA
Power Supply Rejection	$V_{S+} = 5\text{ V to }15\text{ V}$	70	80		70	80		dB
T_{MIN} to T_{MAX}		70			70			dB

AD820—SPECIFICATIONS ($V_S = \pm 15\text{ V}$ @ $T_A = 25^\circ\text{C}$, $V_{CM} = 0\text{ V}$, $V_{OUT} = 0\text{ V}$ unless otherwise noted.)

Parameter	Conditions	AD820A			AD820B			Unit
		Min	Typ	Max	Min	Typ	Max	
DC PERFORMANCE								
Initial Offset			0.4	2		0.3	1.0	mV
Max Offset over Temperature			0.5	3		0.5	2	mV
Offset Drift			2			2		$\mu\text{V}/^\circ\text{C}$
Input Bias Current	$V_{CM} = 0\text{ V}$		2	25		2	10	pA
	$V_{CM} = -10\text{ V}$		40			40		pA
at T_{MAX}	$V_{CM} = 0\text{ V}$		0.5	5		0.5	2.5	nA
Input Offset Current			2	20		2	10	pA
at T_{MAX}			0.5			0.5		nA
Open-Loop Gain	$V_O = +10\text{ V}$ to -10 V $R_L = 100\text{ k}\Omega$	500	2000		500	2000		V/mV
T_{MIN} to T_{MAX}		500			500			V/mV
	$R_L = 10\text{ k}\Omega$	100	500		100	500		V/mV
T_{MIN} to T_{MAX}		100			100			V/mV
	$R_L = 1\text{ k}\Omega$	30	45		30	45		V/mV
T_{MIN} to T_{MAX}		20			20			V/mV
NOISE/HARMONIC PERFORMANCE								
Input Voltage Noise								
0.1 Hz to 10 Hz			2			2		$\mu\text{V p-p}$
$f = 10\text{ Hz}$			25			25		$\text{nV}/\sqrt{\text{Hz}}$
$f = 100\text{ Hz}$			21			21		$\text{nV}/\sqrt{\text{Hz}}$
$f = 1\text{ kHz}$			16			16		$\text{nV}/\sqrt{\text{Hz}}$
$f = 10\text{ kHz}$			13			13		$\text{nV}/\sqrt{\text{Hz}}$
Input Current Noise								
0.1 Hz to 10 Hz			18			18		fA p-p
$f = 1\text{ kHz}$			0.8			0.8		fA/ $\sqrt{\text{Hz}}$
Harmonic Distortion	$R_L = 10\text{ k}\Omega$ $V_O = \pm 10\text{ V}$			-85			-85	dB
DYNAMIC PERFORMANCE								
Unity Gain Frequency			1.9			1.9		MHz
Full Power Response	$V_O\text{ p-p} = 20\text{ V}$		45			45		kHz
Slew Rate			3			3		V/ μs
Settling Time								
to 0.1%	$V_O = 0\text{ V}$ to $\pm 10\text{ V}$		4.1			4.1		μs
to 0.01%			4.5			4.5		μs
INPUT CHARACTERISTICS								
Common-Mode Voltage Range ¹		-15.2		+14	-15.2		+14	V
T_{MIN} to T_{MAX}		-15.2		+14	-15.2		+14	V
CMRR	$V_{CM} = -15\text{ V}$ to 12 V	70	80		74	90		dB
T_{MIN} to T_{MAX}		70			74			dB
Input Impedance								
Differential		10^{13}	0.5		10^{13}	0.5		Ω pF
Common Mode		10^{13}	2.8		10^{13}	2.8		Ω pF
OUTPUT CHARACTERISTICS								
Output Saturation Voltage ²								
$V_{OL}-V_{EE}$	$I_{SINK} = 20\text{ }\mu\text{A}$		5	7		5	7	mV
T_{MIN} to T_{MAX}				10			10	mV
$V_{CC}-V_{OH}$	$I_{SOURCE} = 20\text{ }\mu\text{A}$		10	14		10	14	mV
T_{MIN} to T_{MAX}				20			20	mV
$V_{OL}-V_{EE}$	$I_{SINK} = 2\text{ mA}$		40	55		40	55	mV
T_{MIN} to T_{MAX}				80			80	mV
$V_{CC}-V_{OH}$	$I_{SOURCE} = 2\text{ mA}$		80	110		80	110	mV
T_{MIN} to T_{MAX}				160			160	mV
$V_{OL}-V_{EE}$	$I_{SINK} = 15\text{ mA}$		300	500		300	500	mV
T_{MIN} to T_{MAX}				1000			1000	mV
$V_{CC}-V_{OH}$	$I_{SOURCE} = 15\text{ mA}$		800	1500		800	1500	mV
T_{MIN} to T_{MAX}				1900			1900	mV
Operating Output Current		20			20			mA
T_{MIN} to T_{MAX}		15			15			mA
Short-Circuit Current			45			45		mA
Capacitive Load Drive			350			350		
POWER SUPPLY								
Quiescent Current	T_{MIN} to T_{MAX}		700	900		700	900	μA
Power Supply Rejection	$V_S = +5\text{ V}$ to 15 V	70	80		70	80		dB
T_{MIN} to T_{MAX}		70			70			dB

NOTES

¹This is a functional specification. Amplifier bandwidth decreases when the input common-mode voltage is driven in the range $(+V_S - 1\text{ V})$ to $+V_S$.

Common-mode error voltage is typically less than 5 mV with the common-mode voltage set at 1 volt below the positive supply.

² $V_{OL}-V_{EE}$ is defined as the difference between the lowest possible output voltage (V_{OL}) and the minus voltage supply rail (V_{EE}).

$V_{CC}-V_{OH}$ is defined as the difference between the highest possible output voltage (V_{OH}) and the positive supply voltage (V_{CC}).

Specifications subject to change without notice.

ABSOLUTE MAXIMUM RATINGS¹

Supply Voltage	±18 V
Internal Power Dissipation ²	
Plastic DIP (N)	1.6 W
SOIC (R)	1.0 W
Input Voltage	$(+V_S + 0.2\text{ V})$ to $-(20\text{ V} + V_S)$
Output Short Circuit Duration	Indefinite
Differential Input Voltage	±30 V
Storage Temperature Range (N)	-65°C to +125°C
Storage Temperature Range (R)	-65°C to +150°C
Operating Temperature Range	
AD820A/B	-40°C to +85°C
Lead Temperature Range	
(Soldering 60 sec)	260°C

NOTES

¹Stresses above those listed under Absolute Maximum Ratings may cause permanent damage to the device. This is a stress rating only; functional operation of the device at these or any other conditions above those indicated in the operational section of this specification is not implied. Exposure to absolute maximum rating conditions for extended periods may affect device reliability.

²8-Lead Plastic DIP Package: $\theta_{JA} = 90^\circ\text{C}/\text{W}$

8-Lead SOIC Package: $\theta_{JA} = 160^\circ\text{C}/\text{W}$

ORDERING GUIDE

Model	Temperature Range	Package Description	Package Options
AD820AN	-40°C to +85°C	8-Lead Plastic Mini-DIP	N-8
AD820BN*	-40°C to +85°C	8-Lead Plastic Mini-DIP	N-8
AD820AR	-40°C to +85°C	8-Lead SOIC	R-8
AD820BR	-40°C to +85°C	8-Lead SOIC	R-8

*Not for new design, obsolete April 2002.

CAUTION

ESD (electrostatic discharge) sensitive device. Electrostatic charges as high as 4000 V readily accumulate on the human body and test equipment and can discharge without detection. Although the AD820 features proprietary ESD protection circuitry, permanent damage may occur on devices subjected to high-energy electrostatic discharges. Therefore, proper ESD precautions are recommended to avoid performance degradation or loss of functionality.



AD820—Typical Performance Characteristics

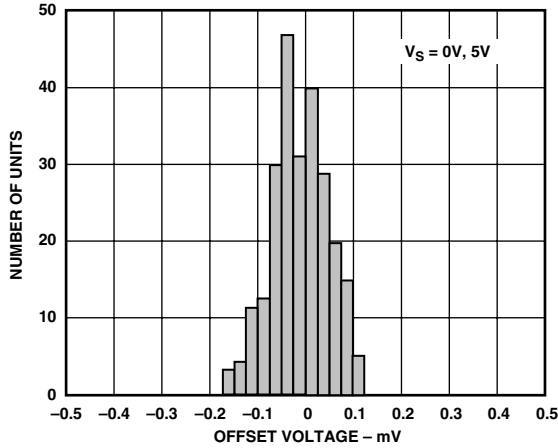

TPC 1. Typical Distribution of Offset Voltage (248 Units)

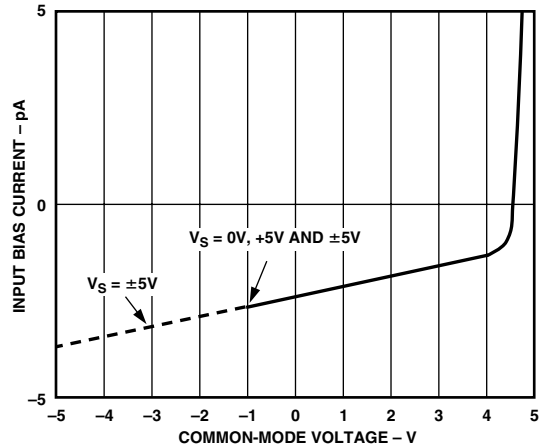

TPC 4. Input Bias Current vs. Common-Mode Voltage; $V_S = +5\text{ V}$, 0 V and $V_S = \pm 5\text{ V}$

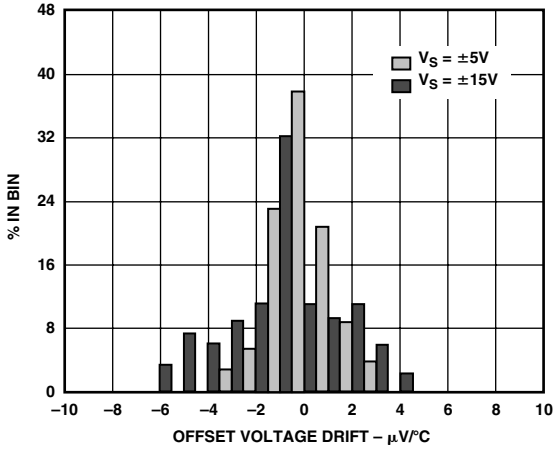

TPC 2. Typical Distribution of Offset Voltage Drift (120 Units)

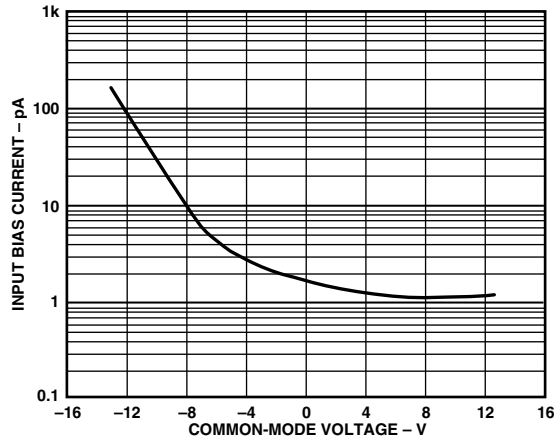

TPC 5. Input Bias Current vs. Common-Mode Voltage; $V_S = \pm 15\text{ V}$

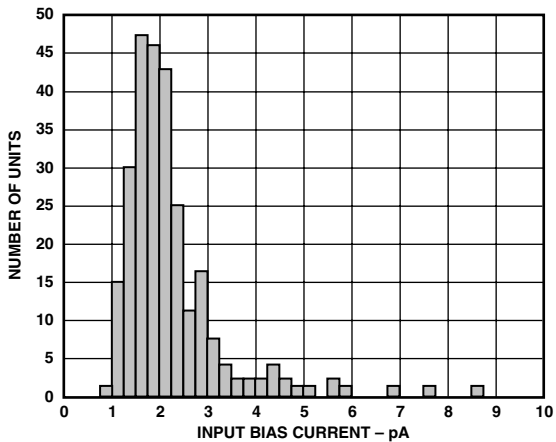

TPC 3. Typical Distribution of Input Bias Current (213 Units)

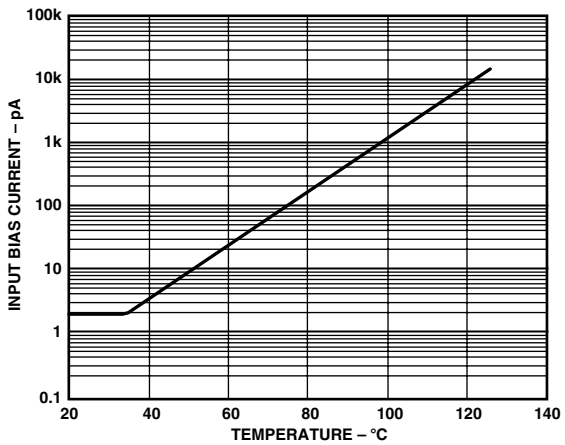

TPC 6. Input Bias Current vs. Temperature; $V_S = 5\text{ V}$, $V_{CM} = 0$

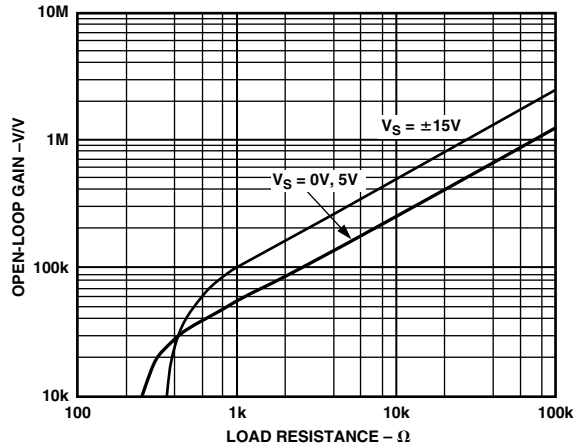

TPC 7. Open-Loop Gain vs. Load Resistance

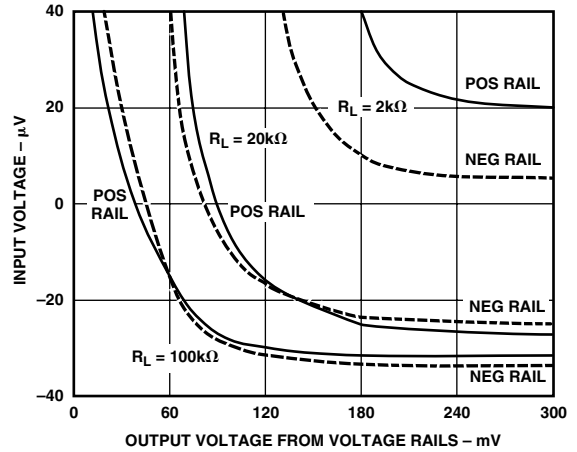

TPC 10. Input Error Voltage with Output Voltage within 300 mV of Either Supply Rail for Various Resistive Loads; $V_S = \pm 5 V$

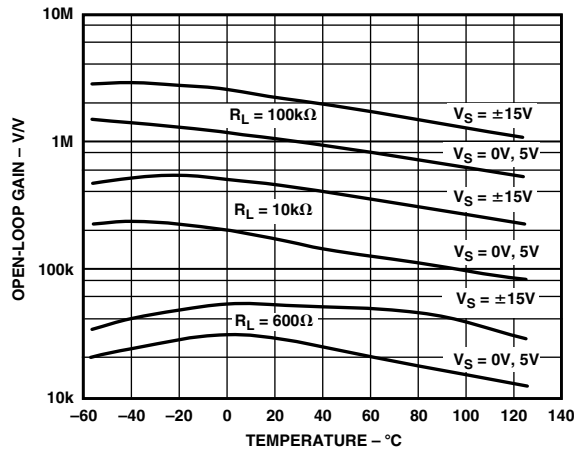

TPC 8. Open-Loop Gain vs. Temperature

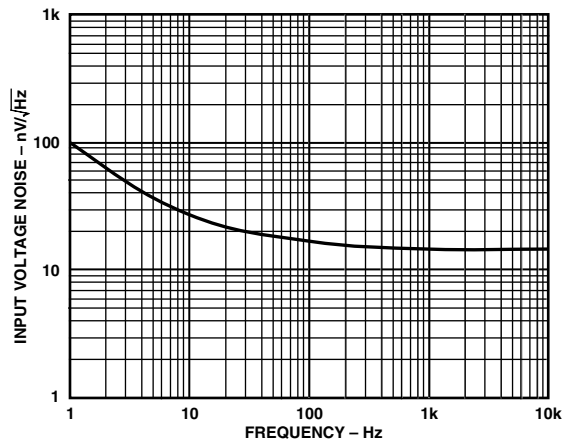

TPC 11. Input Voltage Noise vs. Frequency

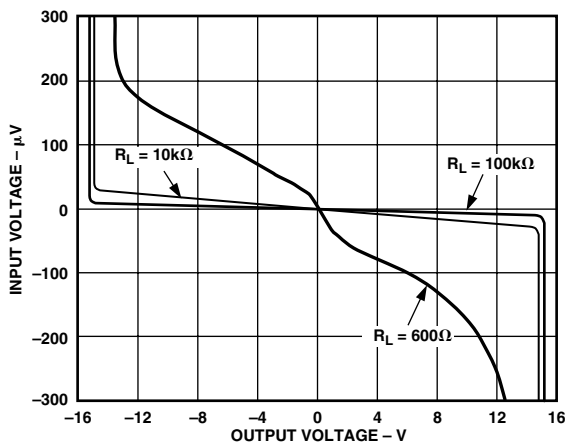

TPC 9. Input Error Voltage vs. Output Voltage for Resistive Loads

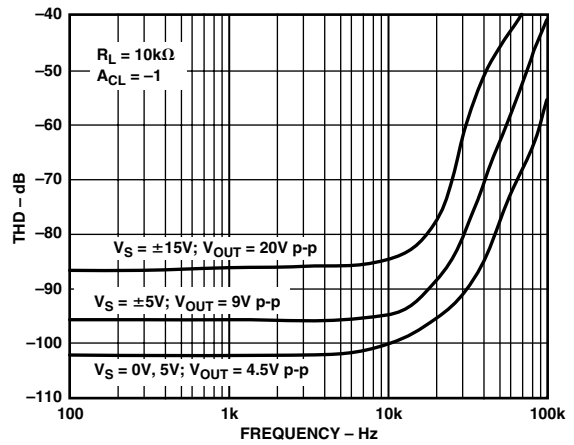

TPC 12. Total Harmonic Distortion vs. Frequency

AD820

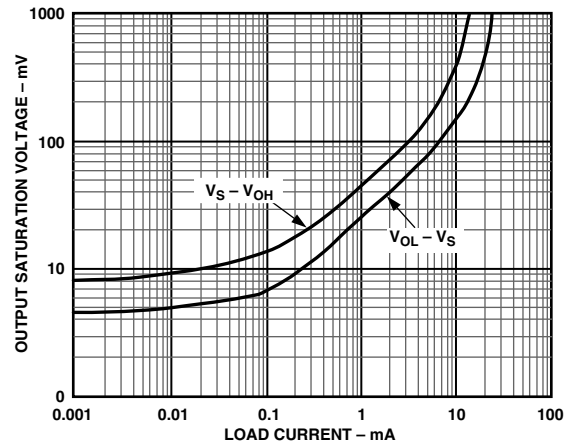
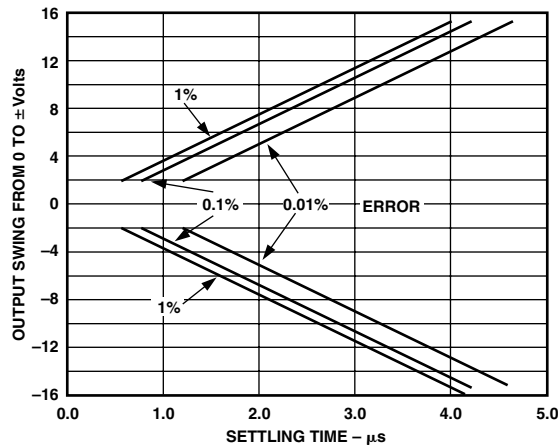
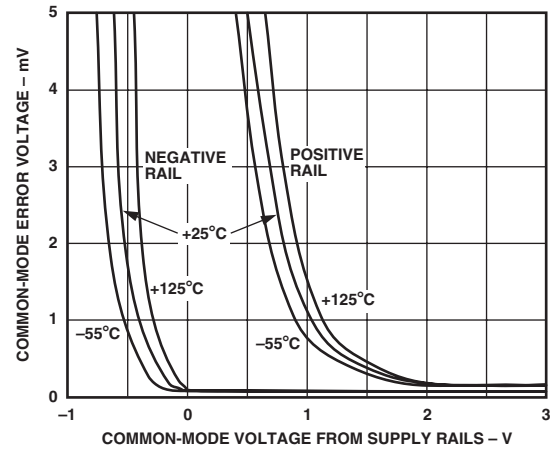
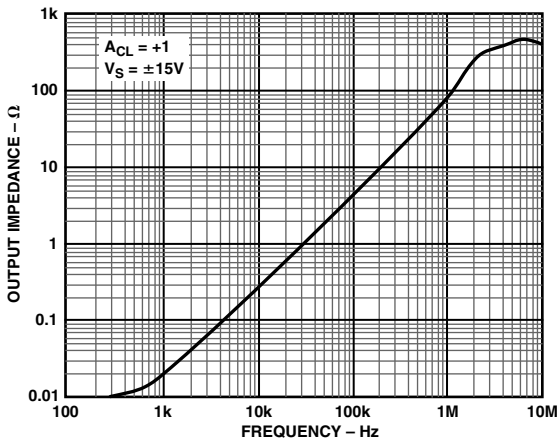
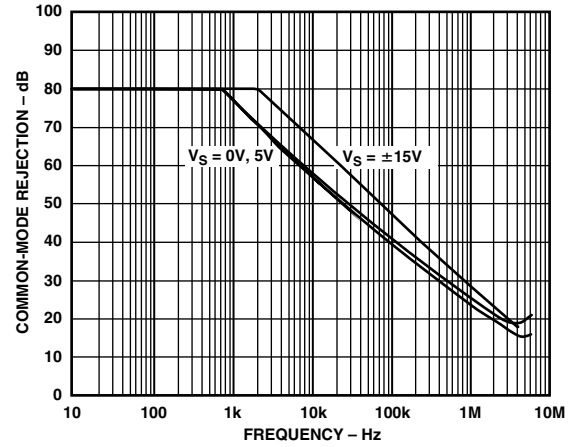
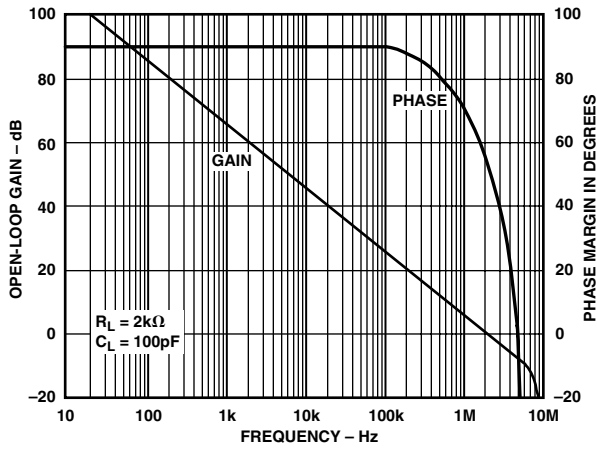

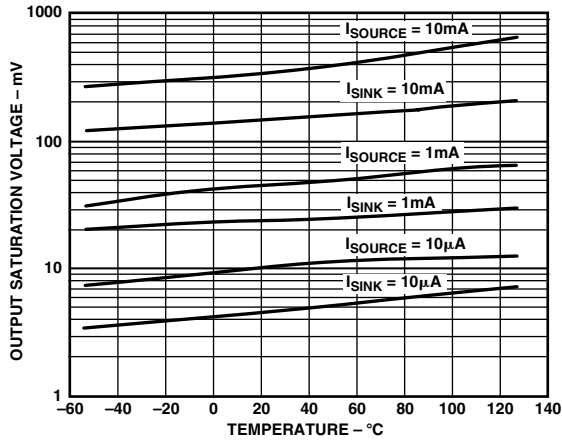

TPC 19. Output Saturation Voltage vs. Temperature

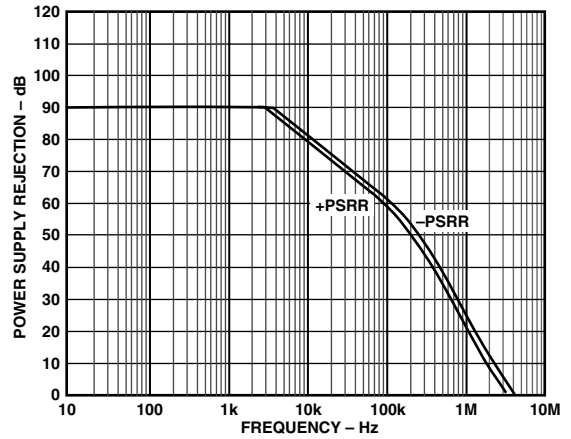

TPC 22. Power Supply Rejection vs. Frequency

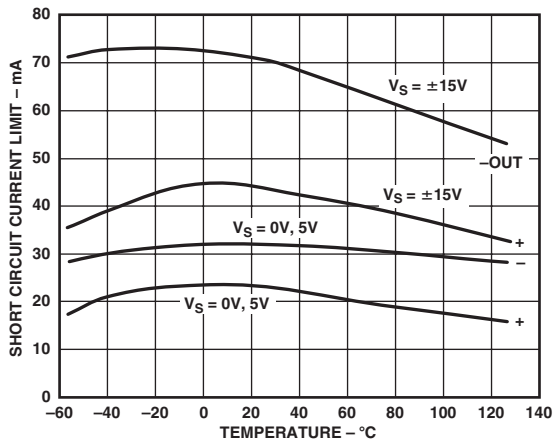

TPC 20. Short Circuit Current Limit vs. Temperature

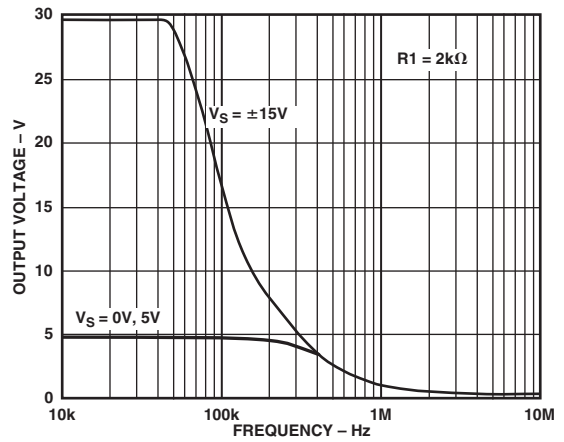

TPC 23. Large Signal Frequency Response

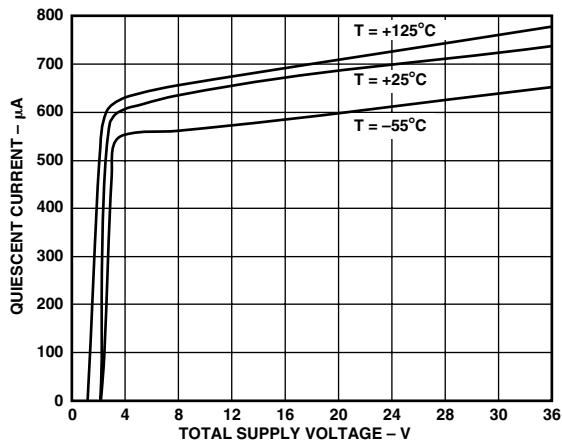

TPC 21. Quiescent Current vs. Supply Voltage vs. Temperature

AD820

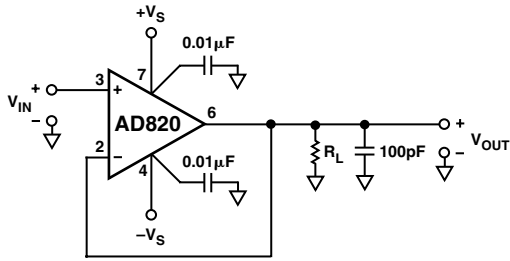

Figure 3. Unity Gain Follower

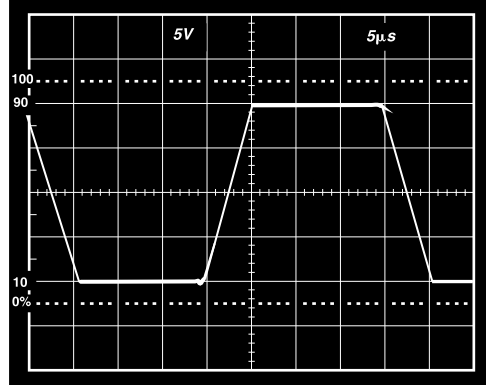

Figure 6. Large Signal Response Unity Gain Follower; $V_S = \pm 15\text{ V}$, $R_L = 10\text{ k}\Omega$

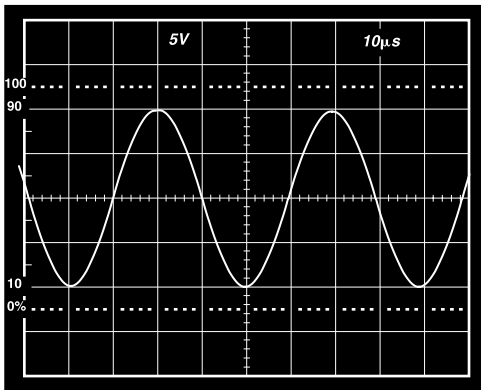

Figure 4. 20 V, 25 kHz Sine Input; Unity Gain Follower; $R_L = 600\ \Omega$, $V_S = \pm 15\text{ V}$

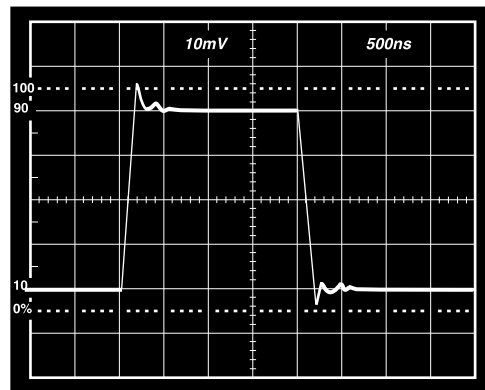

Figure 7. Small Signal Response Unity Gain Follower; $V_S = \pm 15\text{ V}$, $R_L = 10\text{ k}\Omega$

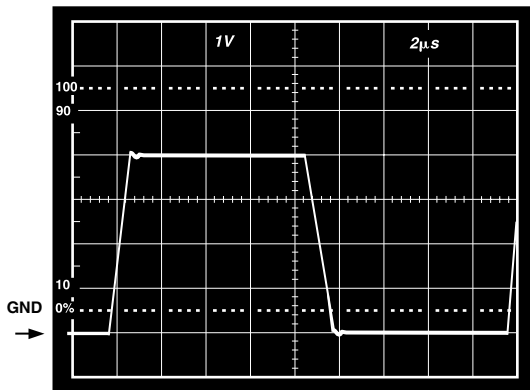

Figure 5. $V_S = 5\text{ V}$, 0 V ; Unity Gain Follower Response to 0 V to 4 V Step

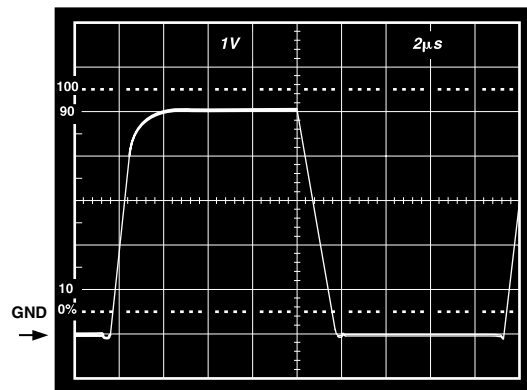

Figure 8. $V_S = 5\text{ V}$, 0 V ; Unity Gain Follower Response to 0 V to 5 V Step

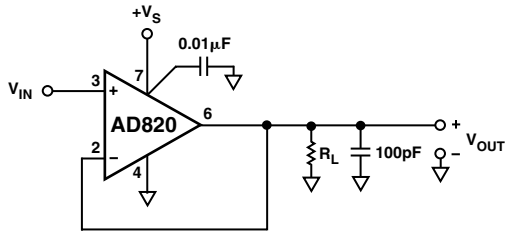

Figure 9. Unity Gain Follower

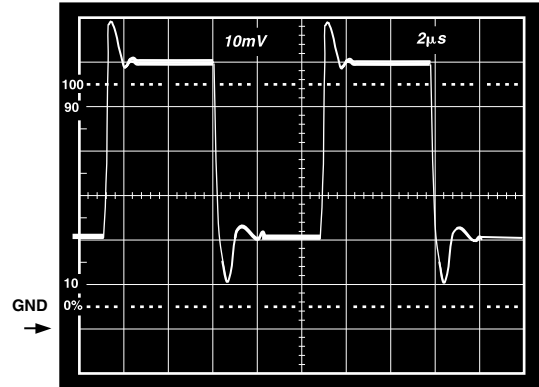

Figure 12. $V_S = 5\text{ V}, 0\text{ V}$; Unity Gain Follower Response to 40 mV Step Centered 40 mV above Ground

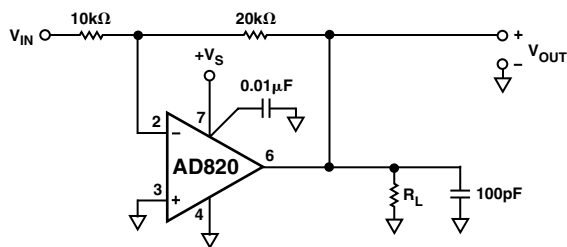

Figure 10. Gain of Two Inverter

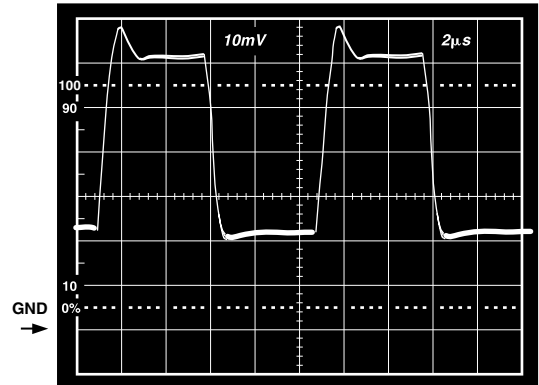

Figure 13. $V_S = 5\text{ V}, 0\text{ V}$; Gain-of-Two Inverter Response to 20 mV Step, Centered 20 mV below Ground

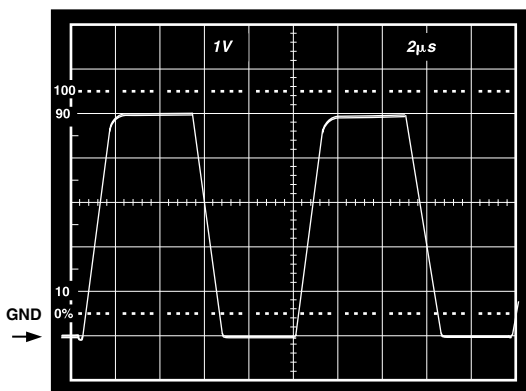

Figure 11. $V_S = 5\text{ V}, 0\text{ V}$; Gain-of-Two Inverter Response to 2.5 V Step Centered -1.25 V below Ground

AD820

APPLICATION NOTES

Input Characteristics

In the AD820, n-channel JFETs are used to provide a low offset, low noise, high impedance input stage. Minimum input common-mode voltage extends from 0.2 V below $-V_S$ to 1 V less than $+V_S$. Driving the input voltage closer to the positive rail will cause a loss of amplifier bandwidth (as can be seen by comparing the large signal responses shown in Figures 5 and 8) and increased common-mode voltage error as illustrated in TPC 11.

The AD820 does not exhibit phase reversal for input voltages up to and including $+V_S$. Figure 14a shows the response of an AD820 voltage follower to a 0 V to 5 V ($+V_S$) square wave input. The input and output are superimposed. The output polarity tracks the input polarity up to $+V_S$ —no phase reversal. The reduced bandwidth above a 4 V input causes the rounding of the output wave form. For input voltages greater than $+V_S$, a resistor in series with the AD820's plus input will prevent phase reversal, at the expense of greater input voltage noise. This is illustrated in Figure 14b.

Since the input stage uses n-channel JFETs, input current during normal operation is negative; the current flows out from the input terminals. If the input voltage is driven more positive than $+V_S - 0.4$ V, the input current will reverse direction as internal device junctions become forward biased. This is illustrated in TPC 4.

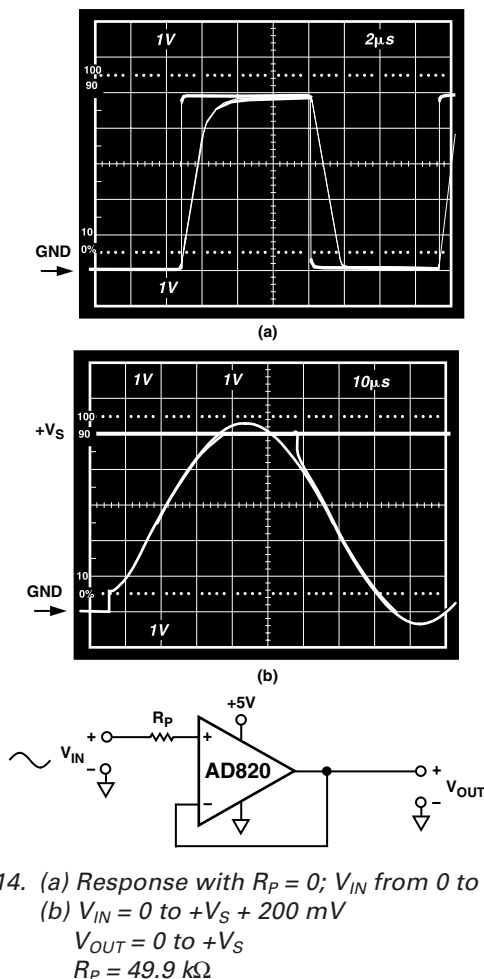

Figure 14. (a) Response with $R_P = 0$; V_{IN} from 0 to $+V_S$
 (b) $V_{IN} = 0$ to $+V_S + 200$ mV
 $V_{OUT} = 0$ to $+V_S$
 $R_P = 49.9$ k Ω

A current limiting resistor should be used in series with the input of the AD820 if there is a possibility of the input voltage exceeding the positive supply by more than 300 mV, or if an input voltage will be applied to the AD820 when $\pm V_S = 0$. The amplifier will be damaged if left in that condition for more than 10 seconds. A 1 k Ω resistor allows the amplifier to withstand up to 10 volts of continuous overvoltage, and increases the input voltage noise by a negligible amount.

Input voltages less than $-V_S$ are a completely different story. The amplifier can safely withstand input voltages 20 V below the minus supply voltage as long as the total voltage from the positive supply to the input terminal is less than 36 V. In addition, the input stage typically maintains picoamp level input currents across that input voltage range.

The AD820 is designed for 13 nV/ $\sqrt{\text{Hz}}$ wideband input voltage noise and maintains low noise performance to low frequencies (refer to TPC 11). This noise performance, along with the AD820's low input current and current noise means that the AD820 contributes negligible noise for applications with source resistances greater than 10 k Ω and signal bandwidths greater than 1 kHz. This is illustrated in Figure 15.

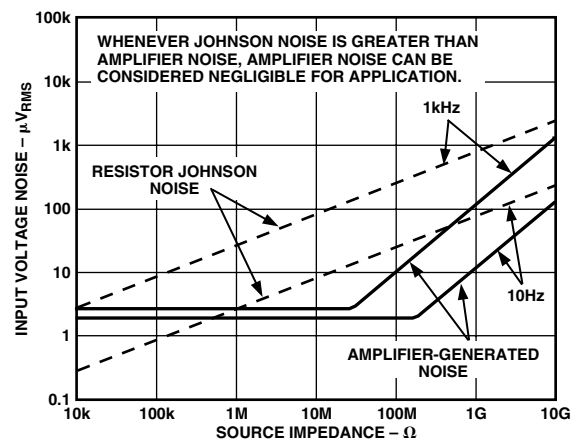

Figure 15. Total Noise vs. Source Impedance

Output Characteristics

The AD820's unique bipolar rail-to-rail output stage swings within 5 mV of the minus supply and 10 mV of the positive supply with no external resistive load. The AD820's approximate output saturation resistance is 40 Ω sourcing and 20 Ω sinking. This can be used to estimate output saturation voltage when driving heavier current loads. For instance, when sourcing 5 mA, the saturation voltage to the positive supply rail will be 200 mV, when sinking 5 mA, the saturation voltage to the minus rail will be 100 mV.

The amplifier's open-loop gain characteristic will change as a function of resistive load, as shown in TPCs 7 through 10. For load resistances over 20 k Ω , the AD820's input error voltage is virtually unchanged until the output voltage is driven to 180 mV of either supply.

If the AD820's output is driven hard against the output saturation voltage, it will recover within 2 μ s of the input returning to the amplifier's linear operating region.

Direct capacitive load will interact with the amplifier's effective output impedance to form an additional pole in the amplifier's feedback loop, which can cause excessive peaking on the pulse response or loss of stability. Worst case is when the amplifier is used as a unity gain follower. Figure 16 shows the AD820's pulse response as a unity gain follower driving 350 pF. This amount of overshoot indicates approximately 20 degrees of phase margin—the system is stable, but is nearing the edge. Configurations with less loop gain, and as a result less loop bandwidth, will be much less sensitive to capacitance load effects. Figure 17 is a plot of capacitive load that will result in a 20 degree phase margin versus noise gain for the AD820. Noise gain is the inverse of the feedback attenuation factor provided by the feedback network in use.

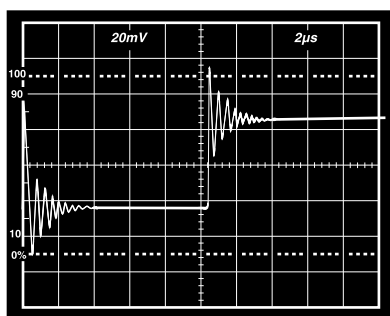

Figure 16. Small Signal Response of AD820 as Unity Gain Follower Driving 350 pF Capacitive Load

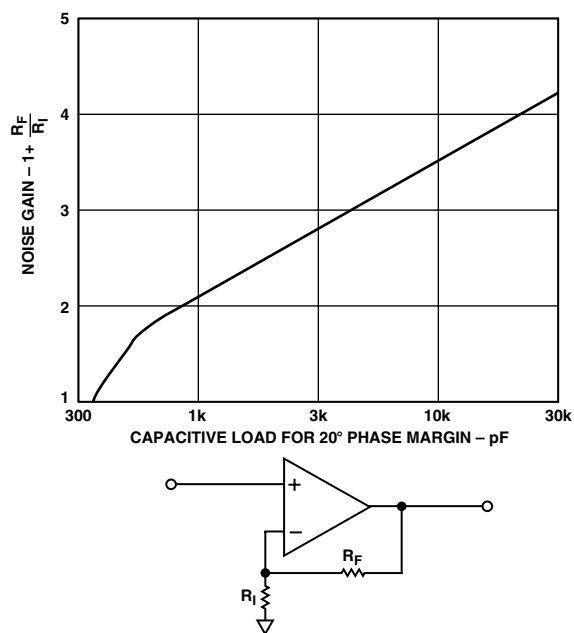

Figure 17. Capacitive Load Tolerance vs. Noise Gain

Figure 18 shows a possible configuration for extending capacitance load drive capability for a unity gain follower. With these component values, the circuit will drive 5,000 pF with a 10% overshoot.

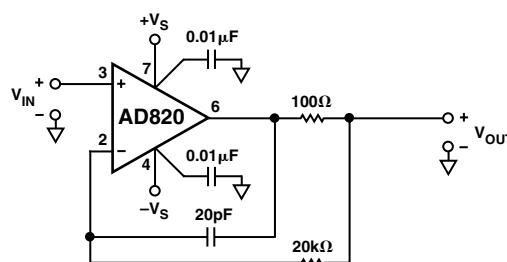

Figure 18. Extending Unity Gain Follower Capacitive Load Capability Beyond 350 pF

OFFSET VOLTAGE ADJUSTMENT

The AD820's offset voltage is low, so external offset voltage nulling is not usually required. Figure 19 shows the recommended technique for AD820's packaged in plastic DIPs. Adjusting offset voltage in this manner will change the offset voltage temperature drift by 4 µV/°C for every millivolt of induced offset. The null pins are not functional for AD820s in the SO-8 "R" package.

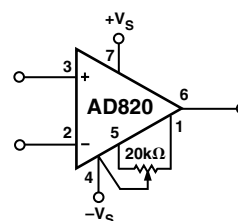

Figure 19. Offset Null

APPLICATIONS

Single Supply Half-Wave and Full-Wave Rectifiers

An AD820 configured as a unity gain follower and operated with a single supply can be used as a simple half-wave rectifier. The AD820's inputs maintain picoamp level input currents even when driven well below the minus supply. The rectifier puts that behavior to good use, maintaining an input impedance of over $10^{11} \Omega$ for input voltages from 1 volt from the positive supply to 20 volts below the negative supply.

The full and half-wave rectifier shown in Figure 20 operates as follows: when V_{IN} is above ground, R_1 is bootstrapped through the unity gain follower A1 and the loop of amplifier A2. This forces the inputs of A2 to be equal, thus no current flows through R_1 or R_2 , and the circuit output tracks the input. When V_{IN} is below ground, the output of A1 is forced to ground. The noninverting input of amplifier A2 sees the ground level output of A1, therefore, A2 operates as a unity gain inverter. The output at node C is then a full-wave rectified version of the input. Node B is a buffered half-wave rectified version of the input. Input voltages up to ± 18 volts can be rectified, depending on the voltage supply used.

AD820

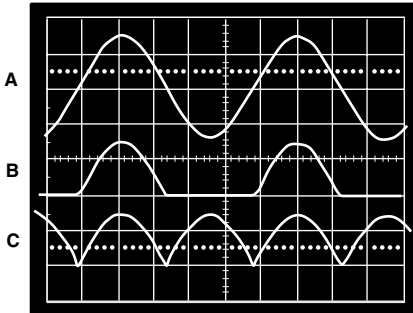
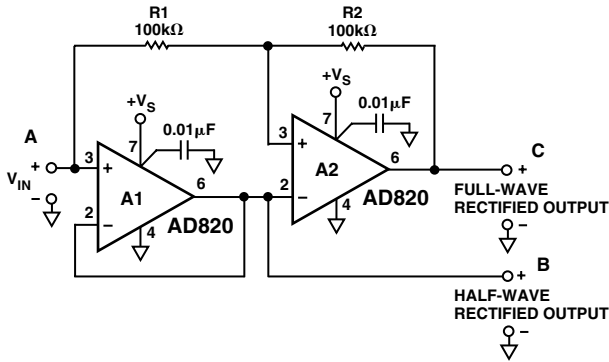

Figure 20. Single Supply Half- and Full-Wave Rectifier

4.5 V Low Dropout, Low Power Reference

The rail-to-rail performance of the AD820 can be used to provide low dropout performance for low power reference circuits powered with a single low voltage supply. Figure 21 shows a 4.5 V reference using the AD820 and the AD680, a low power 2.5 V bandgap reference. R2 and R3 set up the required gain of 1.8 to develop the 4.5 V output. R1 and C2 form a low-pass RC filter to reduce the noise contribution of the AD680.

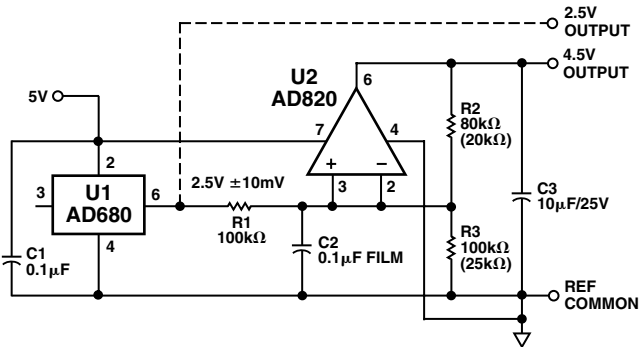

Figure 21. Single Supply 4.5 V Low Dropout Reference

With a 1 mA load, this reference maintains the 4.5 V output with a supply voltage down to 4.7 V. The amplitude of the recovery transient for a 1 mA to 10 mA step change in load current is under 20 mV, and settles out in a few microseconds. Output voltage noise is less than 10 μV rms in a 25 kHz noise bandwidth.

Low Power Three-Pole Sallen Key Low-Pass Filter

The AD820's high input impedance makes it a good selection for active filters. High value resistors can be used to construct low frequency filters with capacitors much less than 1 μF. The AD820's picoamp level input currents contribute minimal dc errors.

Figure 22 shows an example, a 10 Hz three-pole Sallen Key Filter. The high value used for R1 minimizes interaction with signal source resistance. Pole placement in this version of the filter minimizes the Q associated with the two-pole section of the filter. This eliminates any peaking of the noise contribution of resistors R1, R2, and R3, thus minimizing the inherent output voltage noise of the filter.

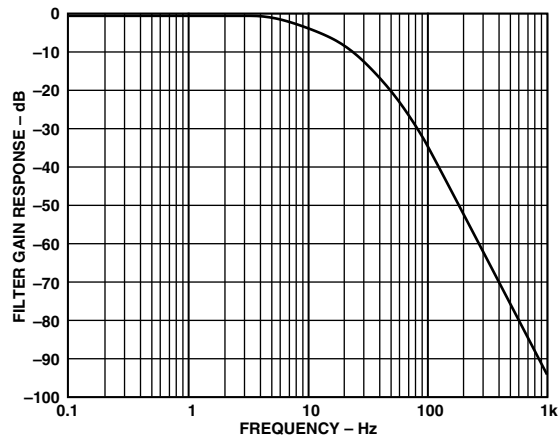
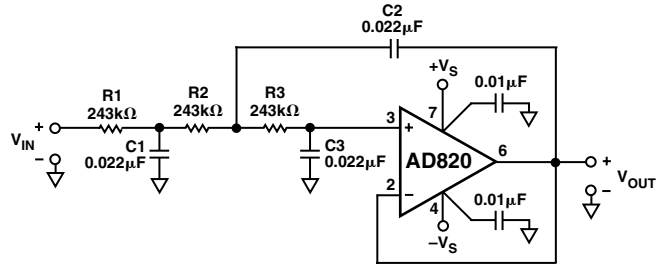
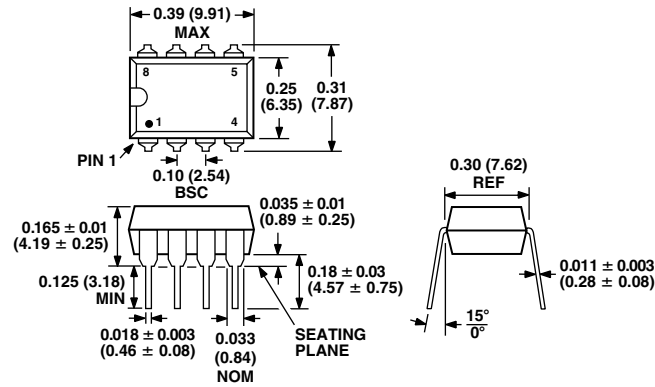

Figure 22. 10 Hz Sallen Key Low-Pass Filter

OUTLINE DIMENSIONS

Mini-DIP Package
(N-8)

Dimensions shown in inches and (millimeters)



SOIC Package
(R-8)

Dimensions shown in millimeters (inches)

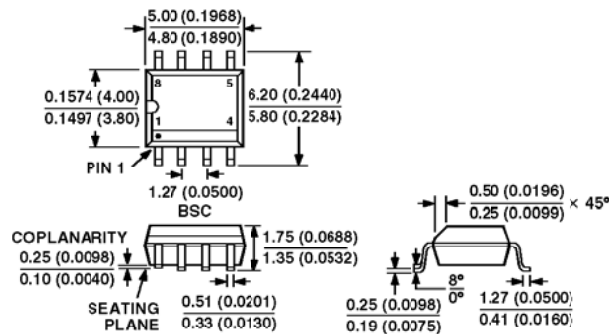

CONTROLLING DIMENSIONS ARE IN MILLIMETERS; INCH DIMENSIONS (IN PARENTHESES) ARE ROUNDED-OFF MILLIMETER EQUIVALENTS FOR REFERENCE ONLY AND ARE NOT APPROPRIATE FOR USE IN DESIGN
COMPLIANT TO JEDEC STANDARDS MS-012 AA

AD820

Revision History

Location	Page
Data Sheet changed from REV. C to REV. D.	
Change to SOIC Package (R-8) Drawing	15
Edits to FEATURES	1
Edits to PRODUCT DESCRIPTION	1
Delete SPECIFICATIONS for AD820A-3 V	5
Edits to ORDERING GUIDE	6
Edits to TYPICAL PERFORMANCE CHARACTERISTICS	8

C00873-0-5/02(D)

PRINTED IN U.S.A.