

AN7351K, AN7351SC

Dual Pre-Amplifier ICs for Hi-Fi Cassette Deck

Overview

The AN7351K and the AN7351SC are the single chip ICs designed for pre-amp. for stereo cassette (double deck especially) incorporating 2-ch rec./playback/line amp. and muting/switching circuits.

Features

- Available for double deck
 1. Available for playback amp. tape speed switching
 2. Available for rec. amp. mute function
 3. Available for playback amp. input and output switching function
- Rec. amp. current and voltage both drive output is possible.
- Line amp. + mute circuit built-in
- Playback equalizer switching built-in
- Available for microcomputer direct drive of switching control pin

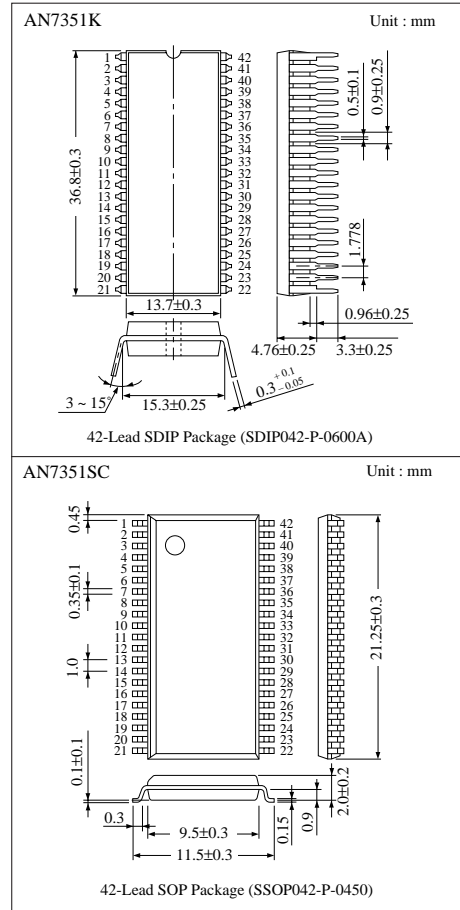

Block Diagram

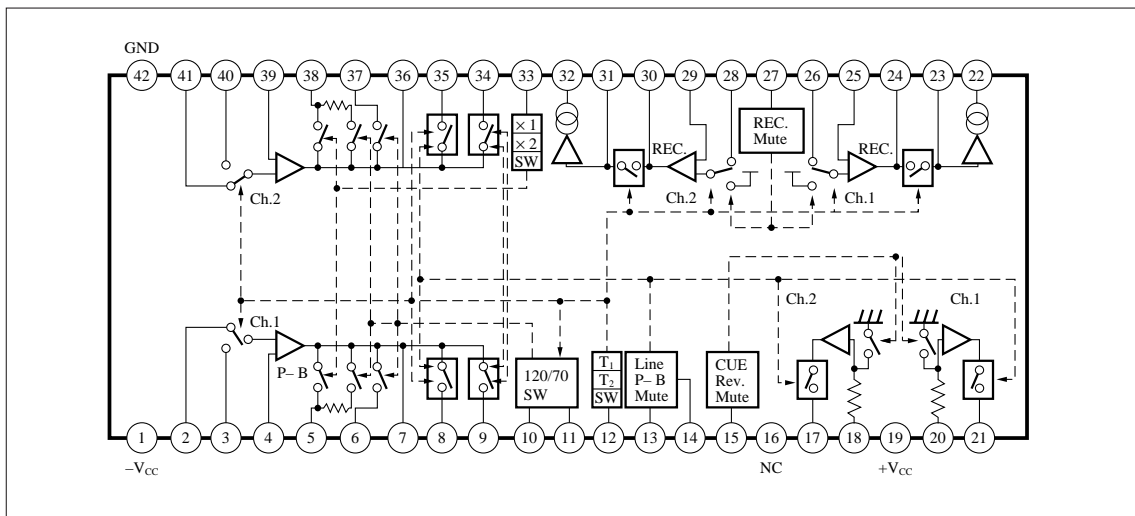

■ Absolute Maximum Ratings (Ta=25°C)

Parameter	Symbol	Rating	Unit
Supply Voltage	V _{CC}	±7.2	V
Supply Current	I _{CC}	39	mA
Power Dissipation	AN7351K	P _D	mW
	AN7351SC		
Operating Ambient Temperature	T _{opr}	-20 ~ + 75	°C
Storage Temperature	AN7351K	T _{stg}	°C
	AN7351SC		

* AN7351K : R_{th(j-a)}=123.3°C/W, AN7351SC : R_{th(j-a)}=127°C/W

■ Recommended Operating Range (Ta= 25°C)

Parameter	Symbol	Range
Operating Supply Voltage Range	V _{CC}	±4.5V ~ ±7V

■ Electrical Characteristics (V_{CC}= ±6V, f=1kHz, Ta=25°C)

Parameter	Symbol	Condition	min.	typ.	max.	Unit
<Playback Amp.> R _L =20kΩ						
Total Harmonic Distortion (1) Tape 1	THD (P1)	V _i =3.6mV Speed × 1 Feedback Time Constant 120μs	—	0.04	0.1	%
Total Harmonic Distortion (2) Tape 1	THD (P2)	V _i =3.6mV Speed × 1 Feedback Time Constant 70μs	—	0.04	0.1	%
Total Harmonic Distortion (3) Tape 2	THD (P3)	V _i =3.6mV Speed × 2 Feedback Time Constant 120μs	—	0.04	0.1	%
Total Harmonic Distortion (4) Tape 2	THD (P4)	V _i =3.6mV Speed × 2 Feedback Time Constant 70μs	—	0.04	0.1	%
Output Noise Voltage Tape 1	V _{N(T1)}	R _g =2.2kΩ, DIN/AUDIO, Speed × 1 Feedback Time Constant 120μs	—	0.7	1.5	mV
Output Noise Voltage Tape 2	V _{N(T2)}	R _g =2.2kΩ, DIN/AUDIO, Speed × 1 Feedback Time Constant 120μs	—	0.7	1.5	mV
Pulse Noise Voltage Tape 1	V _{PN(T1)}	R _g =2.2kΩ, DIN/AUDIO, Speed × 1 Feedback Time Constant 120μs	-0.9	—	9	mV _{P-O}
Pulse Noise Voltage Tape 2	V _{PN(T2)}	R _g =2.2kΩ, DIN/AUDIO, Speed × 1 Feedback Time Constant 120μs	-0.9	—	9	mV _{P-O}
Muting Attenuation Tape 1	R _{M(T1)}	V _i =3.6mV	60	—	—	dB
Muting Attenuation Tape 2	R _{M(T2)}	V _i =3.6mV	60	—	—	dB
Max. Output Voltage Tape 1	V _{O(T1)}	THD=3%	3	3.4	—	V
Max. Output Voltage Tape 2	V _{O(T2)}	THD=3%	3	3.4	—	V
Output Offset Voltage Tape 1	V _{DC(T1)}	R _g =220Ω	-70	—	70	mV
Output Offset Voltage Tape 2	V _{DC(T2)}	R _g =220Ω	-70	—	70	mV
Crosstalk Tape 1→Tape 2	CT (T1)	V _i =3.6mV	60	—	—	dB
Crosstalk Tape 2→Tape 1	CT (T2)	V _i =3.6mV	60	—	—	dB
<Rec. Amp>						
Total Harmonic Distortion VOL	THD (RV)	V _i =200mV	—	0.03	0.1	%
Total Harmonic Distortion CUR	THD (RC)	V _i =30mV	—	0.03	0.2	%
Max. Output Voltage VOL	V _{O(RV)}	THD=3%, R _L =10Ω	2.2	3.2	—	V
Max. Output Voltage CUR	V _{O(RC)}	THD=3%, R _L =1Ω	1	1.5	—	V
Muting Attenuation VOL	R _{M(RV)}	V _i =200mV	75	—	—	dB
Output Noise Voltage CUR	V _{N(RC)}	R _g =2.2kΩ, DIN/AUDIO	—	0.03	1	mV
Pulse Noise Voltage CUR	V _{PN(RC)}	R _g =2.2KΩ	-9	—	9	mV _{P-O}
Output Offset Current CUR	I _{DC(RC)}	R _g =5KΩ	-25	—	25	μA

■ Electrical Characteristics (Cont.) ($V_{CC} = \pm 6V$, $f = 1kHz$, $T_a = 25^\circ C$)

Parameter	Symbol	Condition	min.	typ.	max.	Unit
<Line Amp.>						
Total Harmonic Distortion	THD (L)	$V_i = 1V$	—	0.02	0.07	%
Max. Output Voltage	$V_{O(L)}$	THD=3%	3	3.6	—	V
Muting Attenuation	$R_{M(L)}$	$V_i = 1V, R_L = 5.1k\Omega$	80	—	—	dB
CUE/REV Distortion	$R_{M(C/R)}$	$V_i = 1V, R_L = 5.1k\Omega$	34	37	40	dB
Output Noise Voltage	$V_{N(L)}$	$R_g = 5k\Omega, \text{DIN/AUDIO}$	—	0.01	0.03	mV
Pulse Noise Voltage	$V_{PN(L)}$	$R_g = 5k\Omega$	-9	—	9	mV _{P-o}
Output Offset Voltage	$V_{DC(L)}$	$R_g = 10k\Omega$	-20	—	20	mV
Voltage Gain	$G(L)$	$V_i = 1V$	-0.8	0	0.8	dB
<Logic>						
Time Constant Switching Pin Voltage	$V_{i(T1)}$	Pin11 Voltage at 120 μs , $V_{CC} = 4.5V$	0	—	1.5	V
Time Constant Switching Pin Voltage	$V_{i(T2)}$	Pin10 Voltage at 120 μs , $V_{CC} = 4.5V$	0	—	1.5	V
Tape Switching Pin Voltage	$V_{T1/T2}$	Pin12 Voltage at T ₂ Mode, $V_{CC} = 4.5V$	0	—	1.45	V
L/P Mute Pin Voltage	$V_{M(L/P)}$	Pin13 Voltage at Mute OFF, $V_{CC} = 4.5V$	0	—	1.6	V
C/R Mute Pin Voltage	$V_{M(C/R)}$	Pin15 Voltage at Mute OFF, $V_{CC} = 4.5V$	0	—	1.6	V
Recording Mute Pin Voltage	$V_{M(R)}$	Pin27 Voltage at Mute OFF, $V_{CC} = 4.5V$	0	—	1.6	V
Speed Switching Pin Voltage	$V_{S(H/L)}$	Pin33 Voltage at Double Speed Mode, $V_{CC} = 4.5V$	0	—	1.2	V
Current Consumption	I_{tot}		8	18	34	mA

■ Application Circuit

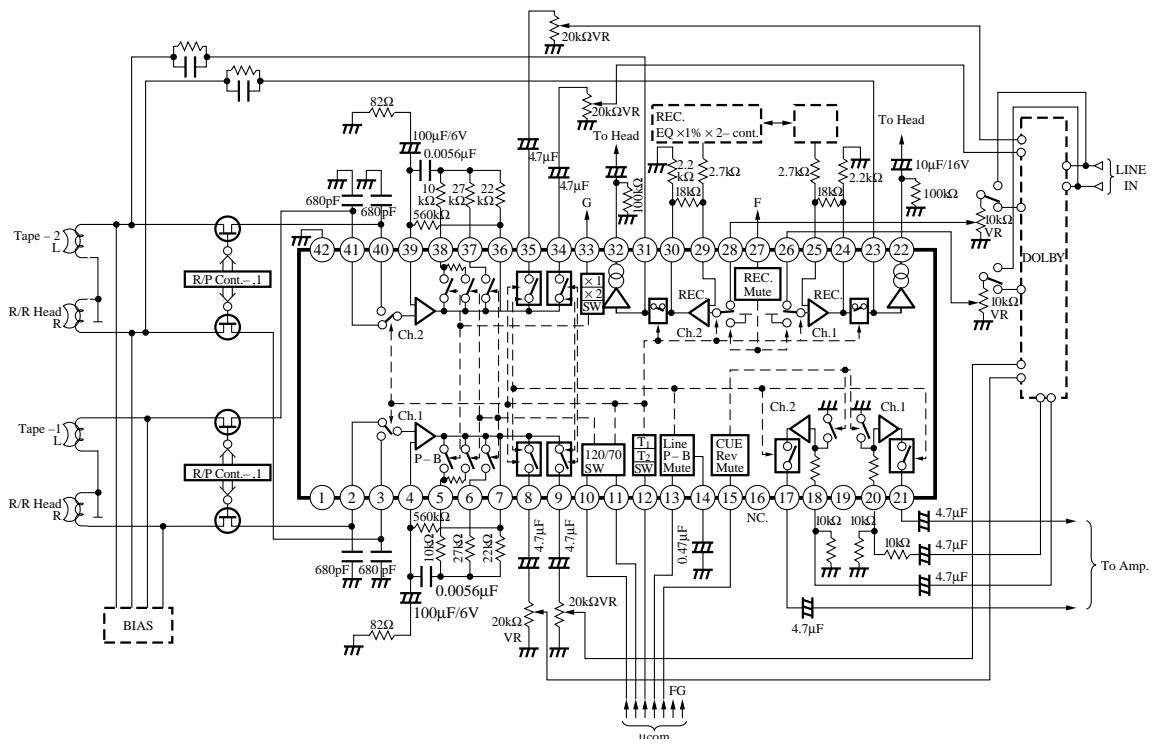







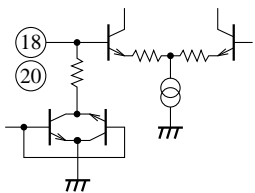

■ Pin Descriptions

Pin No.	Pin Name	Typ. Waveform	Description	Equivalent Circuit
1	Negative Supply Pin	DC -6V	Main circuit -V _{CC}	-----
2	Playback Amp. T ₁ IN (Ch.1)	<p>DC 0V AC 3.6mV</p>	Playback amp. Tape1 input	
41	Playback Amp. T ₁ IN (Ch.2)		Playback amp. Tape2 input	
3	Playback Amp. T ₂ IN (Ch.1)		Playback amp. Tape2 input	
40	Playback Amp. T ₂ IN (Ch.2)			
4	Playback Amp. NF IN (Ch.1)	DC 0V	Playback amp. negative feedback input	
39	Playback Amp. NF IN (Ch.2)			
5	120μs/70μs (×2) NF switch (Ch.1)	<p>DC 0V AC 1V</p>	Playback amp. Double-speed equalizer switching	
38	120μs/70μs (×2) NF switch (Ch.2)			
6	120μs/70μs (×1) NF switch (Ch.1)	<p>DC 0V AC 1V</p>	Playback amp. Normal speed equalizer switching	
37	120μs/70μs (×1) NF switch (Ch.2)			
7	Playback Amp. NF OUT (Ch.1)	<p>- DC 0V AC 1V</p>	Playback amp. negative feedback output	
36	Playback Amp. NF OUT (Ch.2)			
8	Playback Amp. T ₁ OUT (Ch.1)	<p>DC 0V AC 1V</p>	Playback amp. Tape 1 output	
35	Playback Amp. T ₁ OUT (Ch.2)		Playback amp. Tape 2 output	
9	Playback Amp. T ₂ OUT (Ch.1)		Playback amp. Tape 2 output	
34	Playback Amp. T ₂ OUT (Ch.2)		Playback amp. Tape 2 output	

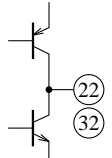
■ Pin Descriptions (Cont.)

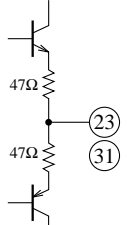
Pin No.	Pin Name	Typ. Waveform	Description	Equivalent Circuit
10	T ₂ (120μs/70μs) LOGIC	————	Tape 2 equalizer switching 70μs – Open 120μs – Low (less than 1.5V)	
11	T ₁ (120μs/70μs) LOGIC	————	Tape 1 equalizer switching 70μs – Open 120μs – Low (less than 1.5V)	
12	T ₁ /T ₂ LOGIC	————	Tape 1 and Tape 2 switching T ₁ – Open T ₂ – Low (less than 1.5V)	
13	LINE/PB Amp. Mute LOGIC	————	Line amp., PB amp. mute switching Mute ON – Open Mute OFF – Low (less than 1.6V)	
14	LINE Mute TIMING	————	Line mute soft switching	
15	CUE/REV Mute LOGIC	————	Mute ON – Open Mute OFF – Low (less than 1.6V)	
16	NC	————	————	————
17	LINE Mute Amp. OUT (Ch.2)	DC 0V	Line amp. output	
21	LINE Mute Amp. OUT (Ch.1)	AC 1V		

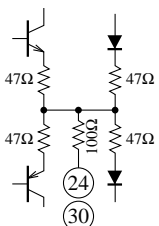
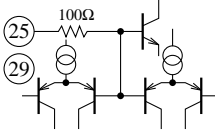
■ Pin Descriptions (Cont.)

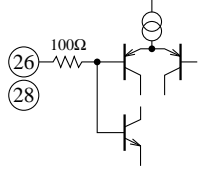
Pin No.	Pin Name	Typ. Waveform	Description	Equivalent Circuit
18	LINE Mute Amp. IN (Ch.2)	DC 0V 	Line amp. input	
20	LINE Mute Amp. IN (Ch.1)	AC 1V		
19	Supply Pin	DC 6V	Main circuit + V _{CC}	—————
22	REC. Amp. Current Out (Ch.1)	DC 0V 	Rec. amp. current output 200mV output at input 30mV, load 100kΩ	
32	REC. Amp. Current Out (Ch.2)			
23	REC. Amp. Voltage Out (Ch.1)	DC 0V 	Rec. amp. voltage output 1.45V output at input 200mV	
31	REC. Amp. Voltage Out (Ch.2)			
24	REC. Amp. NF OUT (Ch.1)	DC 0V 	Rec. amp. feedback output	
30	REC. Amp. NF OUT (Ch.2)			
25	REC. Amp. NF IN (Ch.1)	DC 0V	Rec. amp. negative feedback input	
29	REC. Amp. NF IN (Ch.2)			
26	REC. Amp. IN (Ch.1)	DC 0V 	Rec. amp. input	
28	REC. Amp. IN (Ch.2)			

■ Pin Descriptions (Cont.)

Pin No.	Pin Name	Typ. Waveform	Description	Equivalent Circuit
27	REC. Mute LOGIC	————	Rec. amp. mute switching Mute ON – Open Mute OFF – Low (less than 1.6V)	
33	SPEED H/L LOGIC	————	Speed H/L switching × 1 – Open × 2 – Low (less than 1.2V)	
42	GND	DC 0V	Main Circuit GND	————