

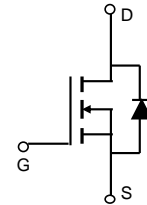
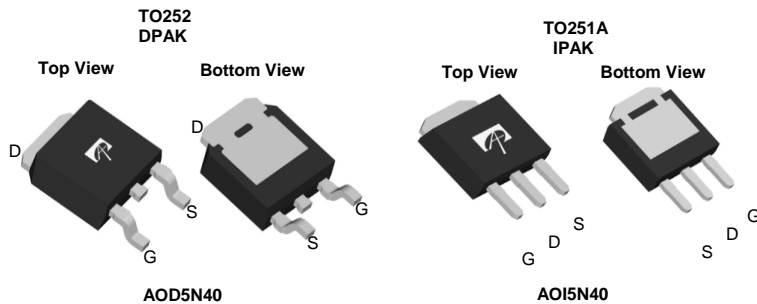
### General Description

The AOD5N40 & AOI5N40 have been fabricated using an advanced high voltage MOSFET process that is designed to deliver high levels of performance and robustness in popular AC-DC applications. By providing low  $R_{DS(on)}$ ,  $C_{iss}$  and  $C_{rss}$  along with guaranteed avalanche capability these parts can be adopted quickly into new and existing offline power supply designs.

### Product Summary

$V_{DS}$	500V@150°C
$I_D$ (at $V_{GS}=10V$ )	4.2A
$R_{DS(ON)}$ (at $V_{GS}=10V$ )	< 1.6Ω

100% UIS Tested!  
 100%  $R_g$  Tested!



### Absolute Maximum Ratings $T_A=25^\circ\text{C}$ unless otherwise noted

Parameter	Symbol	Maximum	Units
Drain-Source Voltage	$V_{DS}$	400	V
Gate-Source Voltage	$V_{GS}$	±30	V
Continuous Drain Current <sup>B</sup>	$I_D$	$T_C=25^\circ\text{C}$	4.2
		$T_C=100^\circ\text{C}$	2.8
Pulsed Drain Current <sup>C</sup>	$I_{DM}$	10	A
Avalanche Current <sup>C</sup>	$I_{AR}$	1.7	A
Repetitive avalanche energy <sup>C</sup>	$E_{AR}$	43	mJ
Single pulsed avalanche energy <sup>H</sup>	$E_{AS}$	86	mJ
Peak diode recovery dv/dt	dv/dt	5	V/ns
Power Dissipation <sup>B</sup>	$P_D$	$T_C=25^\circ\text{C}$	78
		Derate above 25°C	0.63
Junction and Storage Temperature Range	$T_J, T_{STG}$	-50 to 150	°C
Maximum lead temperature for soldering purpose, 1/8" from case for 5 seconds	$T_L$	300	°C

### Thermal Characteristics

Parameter	Symbol	Typical	Maximum	Units
Maximum Junction-to-Ambient <sup>A,G</sup>	$R_{\theta JA}$	38	55	°C/W
Maximum Case-to-sink <sup>A</sup>	$R_{\theta CS}$	-	0.5	°C/W
Maximum Junction-to-Case <sup>D,F</sup>	$R_{\theta JC}$	1.33	1.6	°C/W

**Electrical Characteristics (T<sub>J</sub>=25°C unless otherwise noted)**

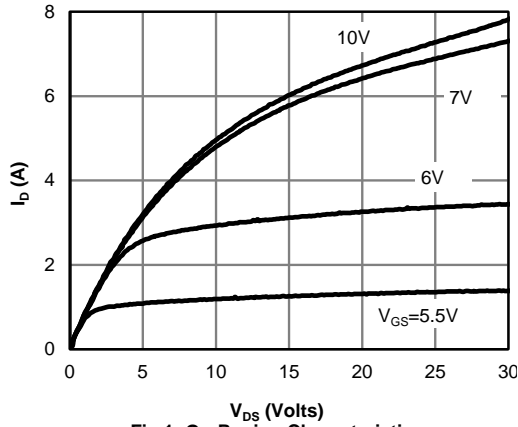
Symbol	Parameter	Conditions	Min	Typ	Max	Units
<b>STATIC PARAMETERS</b>						
BV <sub>DSS</sub>	Drain-Source Breakdown Voltage	I <sub>D</sub> =250μA, V <sub>GS</sub> =0V, T <sub>J</sub> =25°C	400			V
		I <sub>D</sub> =250μA, V <sub>GS</sub> =0V, T <sub>J</sub> =150°C		500		
BV <sub>DSS</sub> /ΔT <sub>J</sub>	Zero Gate Voltage Drain Current	ID=250μA, VGS=0V		0.4		V/°C
I <sub>DSS</sub>	Zero Gate Voltage Drain Current	V <sub>DS</sub> =400V, V <sub>GS</sub> =0V			1	μA
		V <sub>DS</sub> =320V, T <sub>J</sub> =125°C			10	
I <sub>GSS</sub>	Gate-Body leakage current	V <sub>DS</sub> =0V, V <sub>GS</sub> =±30V			±100	nA
V <sub>GS(th)</sub>	Gate Threshold Voltage	V <sub>DS</sub> =5V, I <sub>D</sub> =250μA	3.4	4	4.5	V
R <sub>DS(ON)</sub>	Static Drain-Source On-Resistance	V <sub>GS</sub> =10V, I <sub>D</sub> =1A		1.25	1.6	Ω
g <sub>FS</sub>	Forward Transconductance	V <sub>DS</sub> =40V, I <sub>D</sub> =1A		5		S
V <sub>SD</sub>	Diode Forward Voltage	I <sub>S</sub> =1A, V <sub>GS</sub> =0V		0.77	1	V
I <sub>S</sub>	Maximum Body-Diode Continuous Current				4.2	A
I <sub>SM</sub>	Maximum Body-Diode Pulsed Current				10	A
<b>DYNAMIC PARAMETERS</b>						
C <sub>iss</sub>	Input Capacitance	V <sub>GS</sub> =0V, V <sub>DS</sub> =25V, f=1MHz	260	331	400	pF
C <sub>oss</sub>	Output Capacitance		25	42	60	pF
C <sub>rss</sub>	Reverse Transfer Capacitance		1.5	3	5.5	pF
R <sub>g</sub>	Gate resistance	V <sub>GS</sub> =0V, V <sub>DS</sub> =0V, f=1MHz	2	4	6	Ω
<b>SWITCHING PARAMETERS</b>						
Q <sub>g</sub>	Total Gate Charge	V <sub>GS</sub> =10V, V <sub>DS</sub> =320V, I <sub>D</sub> =4.2A	5.5	6.9	8.5	nC
Q <sub>gs</sub>	Gate Source Charge		1.5	2.0	2.5	nC
Q <sub>gd</sub>	Gate Drain Charge		1	2.3	3.5	nC
t <sub>D(on)</sub>	Turn-On DelayTime	V <sub>GS</sub> =10V, V <sub>DS</sub> =200V, I <sub>D</sub> =4.2A, R <sub>G</sub> =25Ω		16.5		ns
t <sub>r</sub>	Turn-On Rise Time			15		ns
t <sub>D(off)</sub>	Turn-Off DelayTime			24		ns
t <sub>f</sub>	Turn-Off Fall Time			11.5		ns
t <sub>rr</sub>	Body Diode Reverse Recovery Time		I <sub>F</sub> =4.2A, di/dt=100A/μs, V <sub>DS</sub> =100V	125	160	200
Q <sub>rr</sub>	Body Diode Reverse Recovery Charge	I <sub>F</sub> =4.2A, di/dt=100A/μs, V <sub>DS</sub> =100V	0.7	0.93	1.2	μC

- A. The value of R<sub>θJA</sub> is measured with the device in a still air environment with T<sub>A</sub>=25° C.
- B. The power dissipation P<sub>D</sub> is based on T<sub>J(MAX)</sub>=150° C in a TO252 package, using junction-to-case thermal resistance, and is more useful in setting the upper dissipation limit for cases where additional heatsinking is used.
- C. Repetitive rating, pulse width limited by junction temperature T<sub>J(MAX)</sub>=150° C.
- D. The R<sub>θJA</sub> is the sum of the thermal impedance from junction to case R<sub>θJC</sub> and case to ambient.
- E. The static characteristics in Figures 1 to 6 are obtained using <300 μs pulses, duty cycle 0.5% max.
- F. These curves are based on the junction-to-case thermal impedance which is measured with the device mounted to a large heatsink, assuming a maximum junction temperature of T<sub>J(MAX)</sub>=150° C.
- G. These tests are performed with the device mounted on 1 in<sup>2</sup> FR-4 board with 2oz. Copper, in a still air environment with T<sub>A</sub>=25° C.
- H. L=60mH, I<sub>AS</sub>=1.7A, V<sub>DD</sub>=150V, R<sub>G</sub>=10Ω, Starting T<sub>J</sub>=25° C

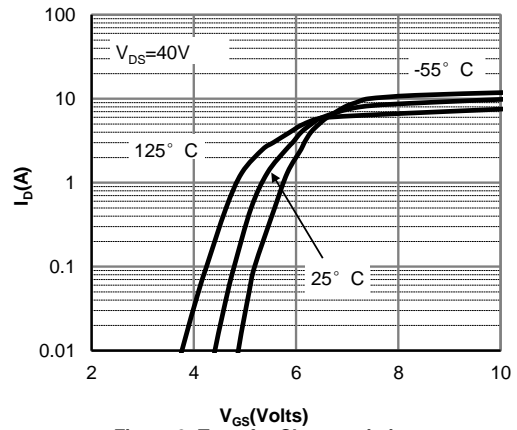
APPLICATIONS OR USES AS CRITICAL COMPONENTS IN LIFE SUPPORT DEVICES OR SYSTEMS ARE NOT AUTHORIZED. AOS DOES NOT ASSUME ANY LIABILITY ARISING OUT OF SUCH APPLICATIONS OR USES OF ITS PRODUCTS. AOS RESERVES THE RIGHT TO MAKE CHANGES TO PRODUCT SPECIFICATIONS WITHOUT NOTICE. IT IS THE RESPONSIBILITY OF THE CUSTOMER TO EVALUATE SUITABILITY OF THE PRODUCT FOR THEIR INTENDED APPLICATION. CUSTOMER SHALL COMPLY WITH APPLICABLE LEGAL REQUIREMENTS, INCLUDING ALL APPLICABLE EXPORT CONTROL RULES, REGULATIONS AND LIMITATIONS.

AOS' products are provided subject to AOS' terms and conditions of sale which are set forth at:  
[http://www.aosmd.com/terms\\_and\\_conditions\\_of\\_sale](http://www.aosmd.com/terms_and_conditions_of_sale)

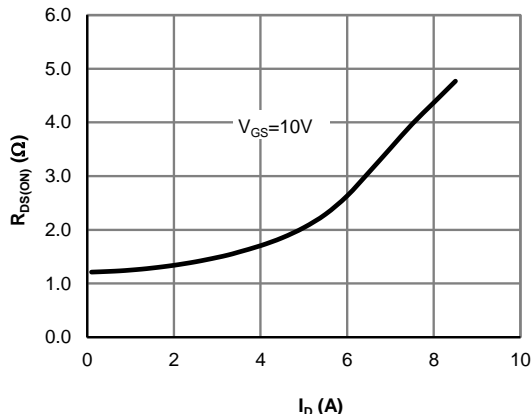
**TYPICAL ELECTRICAL AND THERMAL CHARACTERISTICS**



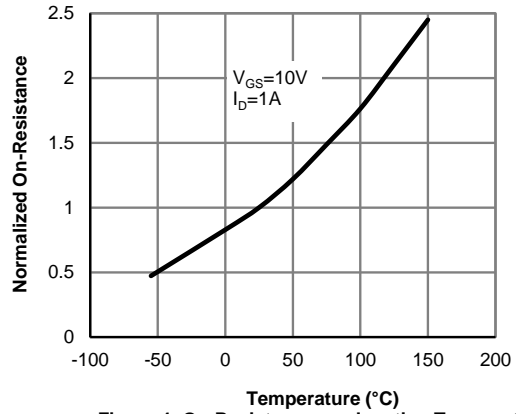
**Fig 1: On-Region Characteristics**



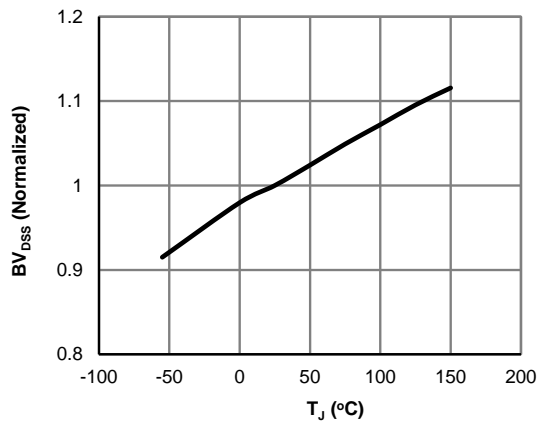
**Figure 2: Transfer Characteristics**



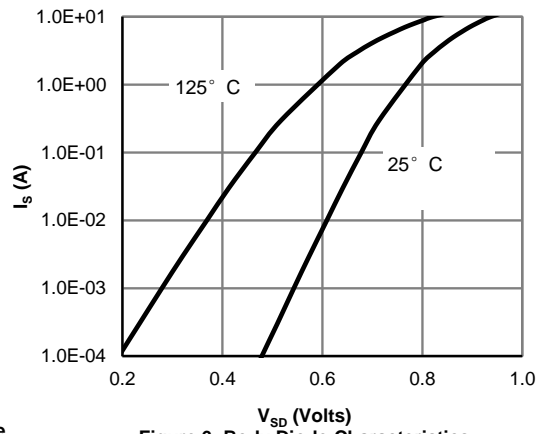
**Figure 3: On-Resistance vs. Drain Current and Gate Voltage**



**Figure 4: On-Resistance vs. Junction Temperature**

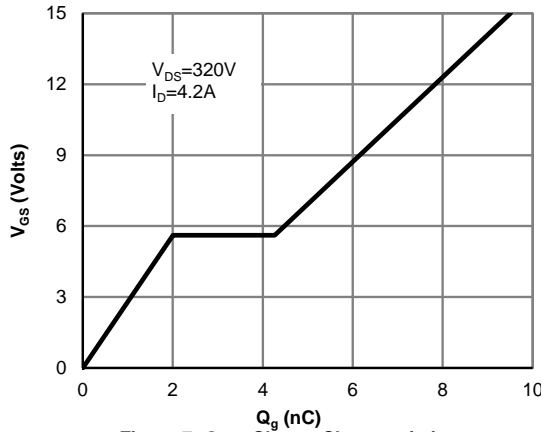


**Figure 5: Break Down vs. Junction Temperature**

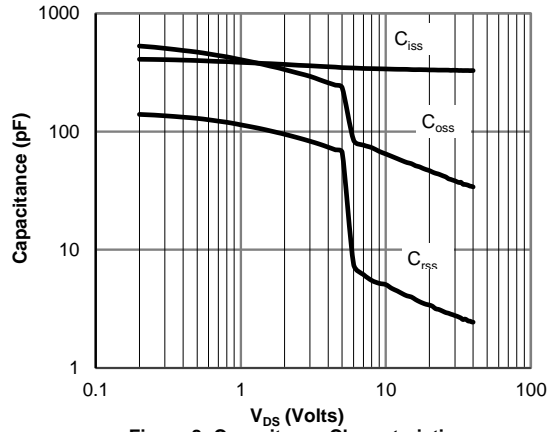


**Figure 6: Body-Diode Characteristics**

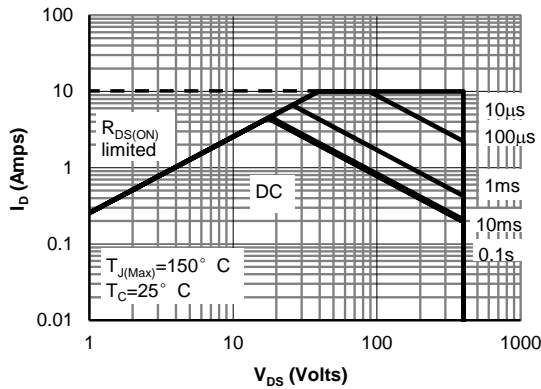
**TYPICAL ELECTRICAL AND THERMAL CHARACTERISTICS**



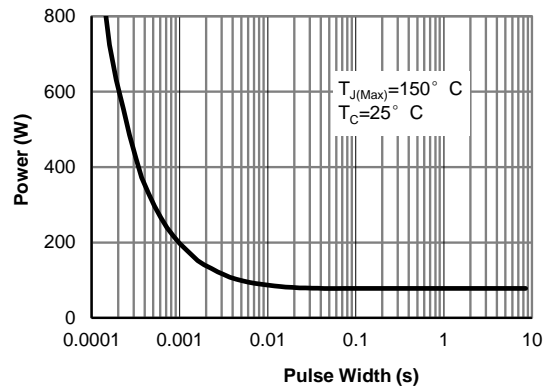
**Figure 7: Gate-Charge Characteristics**



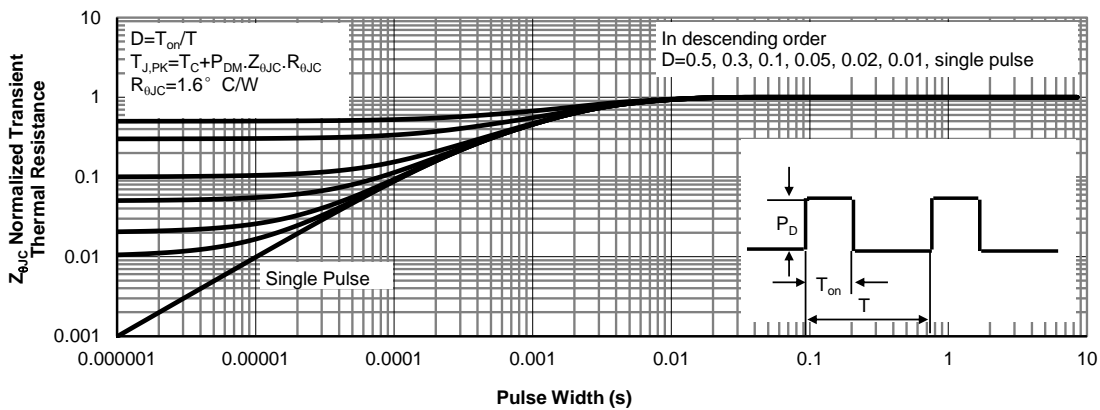
**Figure 8: Capacitance Characteristics**



**Figure 9: Maximum Forward Biased Safe Operating Area (Note F)**



**Figure 10: Single Pulse Power Rating Junction-to-Case (Note F)**



**Figure 11: Normalized Maximum Transient Thermal Impedance (Note F)**

**TYPICAL ELECTRICAL AND THERMAL CHARACTERISTICS**

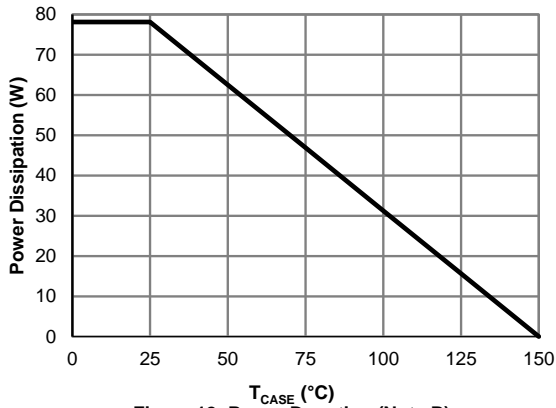


Figure 12: Power De-rating (Note B)

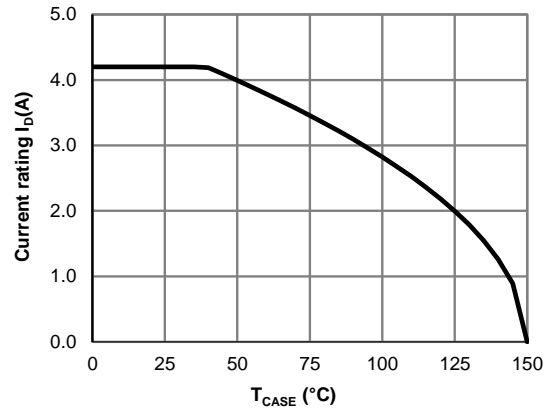


Figure 13: Current De-rating (Note B)

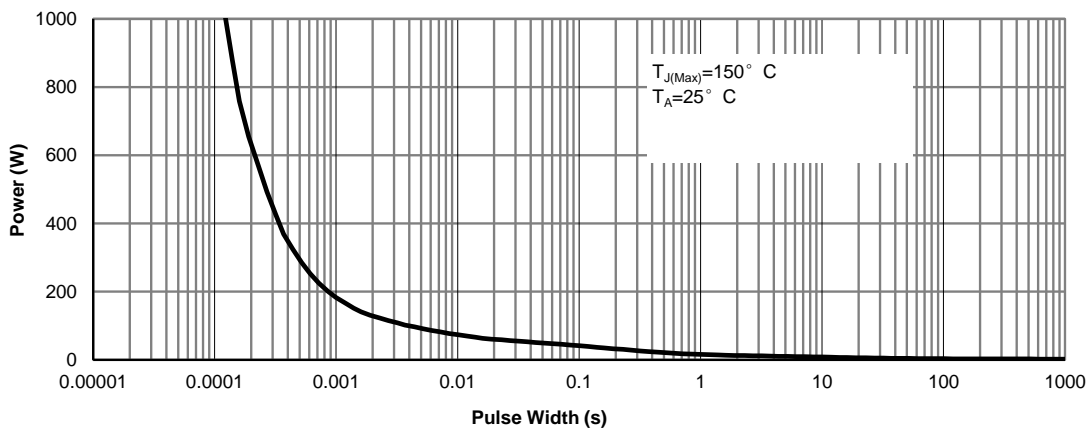


Figure 14: Single Pulse Power Rating Junction-to-Ambient (Note G)

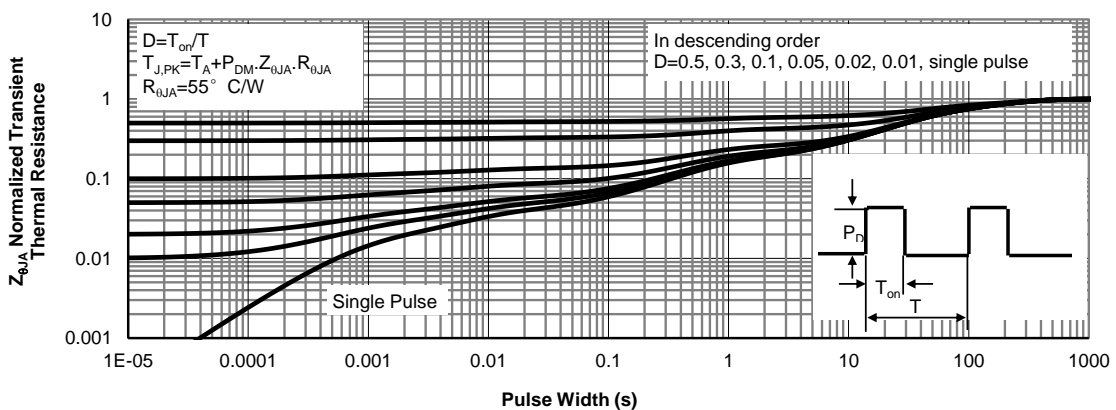
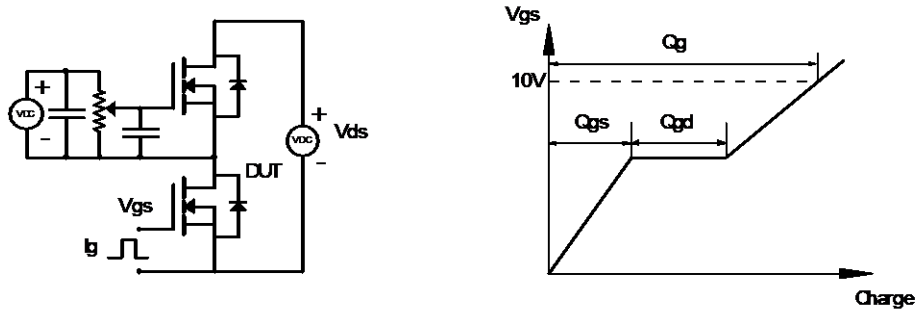
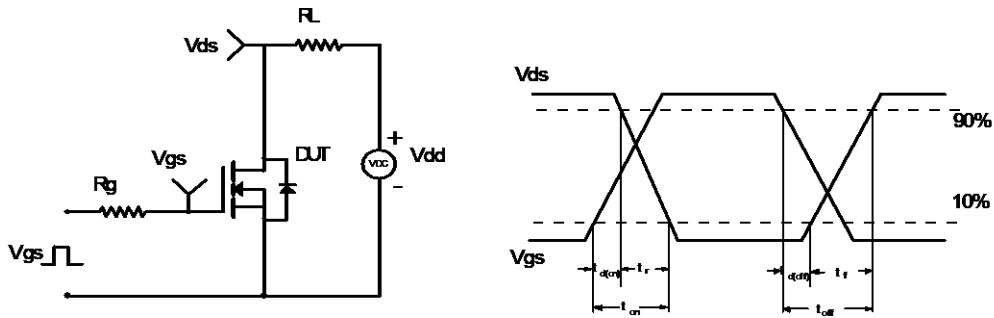


Figure 15: Normalized Maximum Transient Thermal Impedance (Note G)

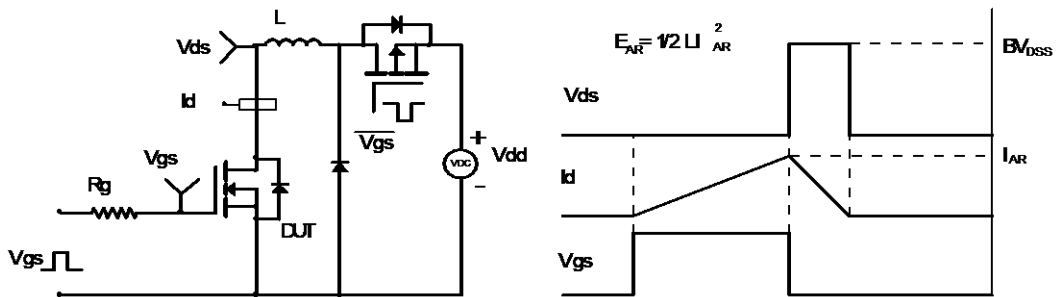
**Gate Charge Test Circuit & Waveform**



**Resistive Switching Test Circuit & Waveforms**



**Unclamped Inductive Switching (UIS) Test Circuit & Waveforms**



**Diode Recovery Test Circuit & Waveforms**

