

Thyristors

BT151 series

GENERAL DESCRIPTION

Passivated thyristors in a plastic envelope, intended for use in applications requiring high bidirectional blocking voltage capability and high thermal cycling performance. Typical applications include motor control, industrial and domestic lighting, heating and static switching.

QUICK REFERENCE DATA

| SYMBOL | PARAMETER | MAX. | MAX. | MAX. | UNIT |
|-----------------------|--------------------------------------|--------------------|--------------------|--------------------|------|
| V_{DRM} , V_{RRM} | Repetitive peak off-state voltages | 500R 500 | 650R 650 | 800R 800 | V |
| $I_{T(AV)}$ | Average on-state current | 7.5 | 7.5 | 7.5 | A |
| $I_{T(RMS)}$ | RMS on-state current | 12 | 12 | 12 | A |
| I_{TSM} | Non-repetitive peak on-state current | 100 | 100 | 100 | A |

PINNING - TO220AB

| PIN | DESCRIPTION |
|-----|-------------|
| 1 | cathode |
| 2 | anode |
| 3 | gate |
| tab | anode |

PIN CONFIGURATION

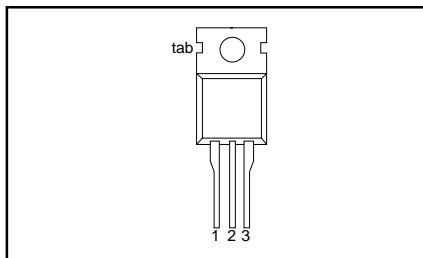

SYMBOL

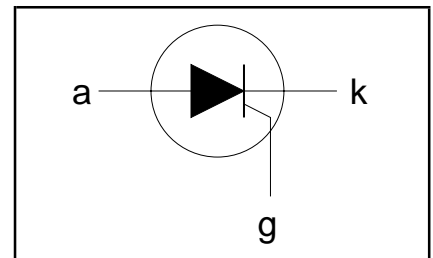

LIMITING VALUES

Limiting values in accordance with the Absolute Maximum System (IEC 134).

| SYMBOL | PARAMETER | CONDITIONS | MIN. | MAX. | | | UNIT |
|-----------------------|--|---|------|----------------------------------|----------------------------------|---------------------|------------------|
| V_{DRM} , V_{RRM} | Repetitive peak off-state voltages | | - | -500R 500 ¹ | -650R 650 ¹ | -800R 800 | V |
| $I_{T(AV)}$ | Average on-state current | half sine wave; $T_{mb} \leq 109\text{ }^\circ\text{C}$ all conduction angles | - | 7.5 | | | A |
| $I_{T(RMS)}$ | RMS on-state current | half sine wave; $T_j = 25\text{ }^\circ\text{C}$ prior to surge | - | 12 | | | A |
| I_{TSM} | Non-repetitive peak on-state current | $t = 10\text{ ms}$ | - | 100 | | | A |
| | | $t = 8.3\text{ ms}$ | - | 110 | | | A |
| | | $t = 10\text{ ms}$ | - | 50 | | | A ² s |
| I^2t | I^2t for fusing | $I_{TM} = 20\text{ A}$; $I_G = 50\text{ mA}$; $dI_G/dt = 50\text{ mA}/\mu\text{s}$ | - | 50 | | | A μs |
| dI_T/dt | Repetitive rate of rise of on-state current after triggering | | - | 5 | | | A/ μs |
| I_{GM} | Peak gate current | | - | 2 | | | A |
| V_{GM} | Peak gate voltage | | - | 5 | | | V |
| V_{RGM} | Peak reverse gate voltage | | - | 5 | | | V |
| P_{GM} | Peak gate power | | - | 5 | | | W |
| $P_{G(AV)}$ | Average gate power | over any 20 ms period | - | 0.5 | | | W |
| T_{stg} | Storage temperature | | -40 | 150 | | | $^\circ\text{C}$ |
| T_j | Operating junction temperature | | - | 125 | | | $^\circ\text{C}$ |

1 Although not recommended, off-state voltages up to 800V may be applied without damage, but the thyristor may switch to the on-state. The rate of rise of current should not exceed 15 A/ μs .

Thyristors

BT151 series

THERMAL RESISTANCES

| SYMBOL | PARAMETER | CONDITIONS | MIN. | TYP. | MAX. | UNIT |
|----------------|--|-------------|------|------|------|------|
| $R_{th\ j-mb}$ | Thermal resistance junction to mounting base | in free air | - | - | 1.3 | K/W |
| $R_{th\ j-a}$ | Thermal resistance junction to ambient | | - | 60 | - | K/W |

STATIC CHARACTERISTICS

 $T_j = 25\text{ °C}$ unless otherwise stated

| SYMBOL | PARAMETER | CONDITIONS | MIN. | TYP. | MAX. | UNIT |
|------------|---------------------------|---|------|------|------|------|
| I_{GT} | Gate trigger current | $V_D = 12\text{ V}; I_T = 0.1\text{ A}$ | - | 2 | 15 | mA |
| I_L | Latching current | $V_D = 12\text{ V}; I_{GT} = 0.1\text{ A}$ | - | 10 | 40 | mA |
| I_H | Holding current | $V_D = 12\text{ V}; I_{GT} = 0.1\text{ A}$ | - | 7 | 20 | mA |
| V_T | On-state voltage | $I_T = 23\text{ A}$ | - | 1.4 | 1.75 | V |
| V_{GT} | Gate trigger voltage | $V_D = 12\text{ V}; I_T = 0.1\text{ A}$ | - | 0.6 | 1.5 | V |
| I_D, I_R | Off-state leakage current | $V_D = V_{DRM(max)}; I_T = 0.1\text{ A}; T_j = 125\text{ °C}$ | 0.25 | 0.4 | - | V |
| | | $V_D = V_{DRM(max)}; V_R = V_{RRM(max)}; T_j = 125\text{ °C}$ | - | 0.1 | 0.5 | mA |

DYNAMIC CHARACTERISTICS

 $T_j = 25\text{ °C}$ unless otherwise stated

| SYMBOL | PARAMETER | CONDITIONS | MIN. | TYP. | MAX. | UNIT |
|-----------|--|--|------|------|------|------------|
| dV_D/dt | Critical rate of rise of off-state voltage | $V_{DM} = 67\% V_{DRM(max)}; T_j = 125\text{ °C};$ exponential waveform; | | | | |
| | | Gate open circuit $R_{GK} = 100\ \Omega$ | 50 | 130 | - | V/ μ s |
| t_{gt} | Gate controlled turn-on time | $I_{TM} = 40\text{ A}; V_D = V_{DRM(max)}; I_G = 0.1\text{ A};$ $di_G/dt = 5\text{ A}/\mu\text{s}$ | 200 | 1000 | - | V/ μ s |
| t_q | Circuit commutated turn-off time | $V_D = 67\% V_{DRM(max)}; T_j = 125\text{ °C};$ $I_{TM} = 20\text{ A}; V_R = 25\text{ V}; di_{TM}/dt = 30\text{ A}/\mu\text{s};$ $dV_D/dt = 50\text{ V}/\mu\text{s}; R_{GK} = 100\ \Omega$ | - | 70 | - | μ s |

Thyristors

BT151 series

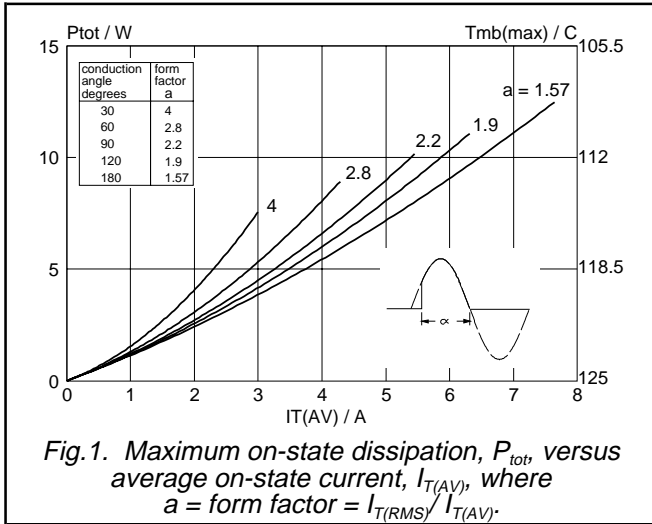

Fig. 1. Maximum on-state dissipation, P_{tot} , versus average on-state current, $I_{T(AV)}$, where $a = \text{form factor} = I_{T(RMS)} / I_{T(AV)}$.

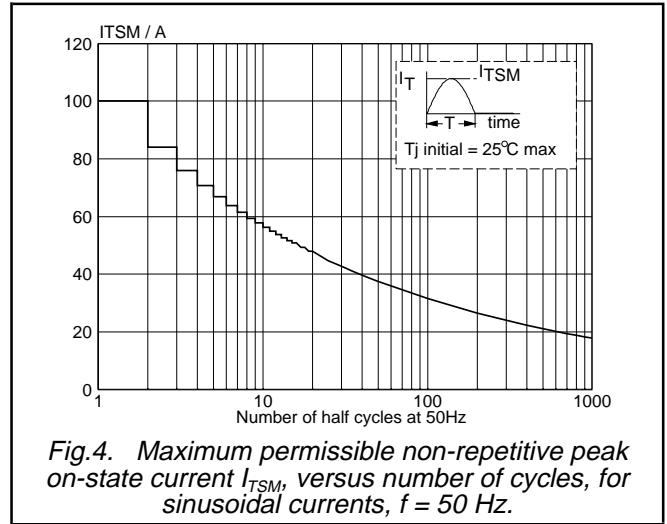

Fig. 4. Maximum permissible non-repetitive peak on-state current I_{TSM} , versus number of cycles, for sinusoidal currents, $f = 50 \text{ Hz}$.

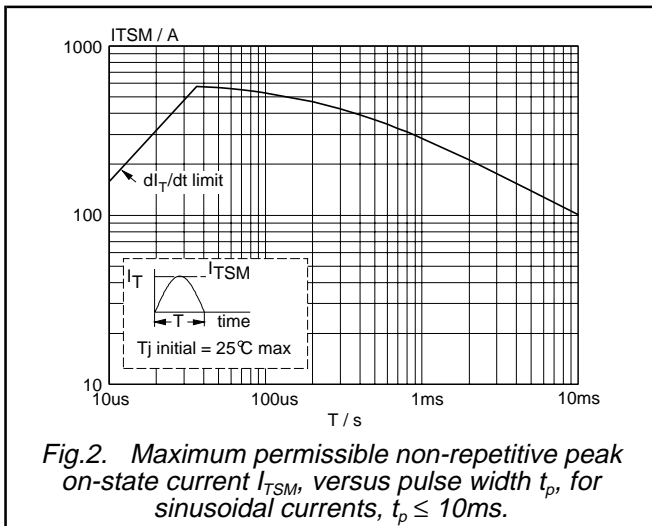

Fig. 2. Maximum permissible non-repetitive peak on-state current I_{TSM} , versus pulse width t_p , for sinusoidal currents, $t_p \leq 10 \text{ ms}$.

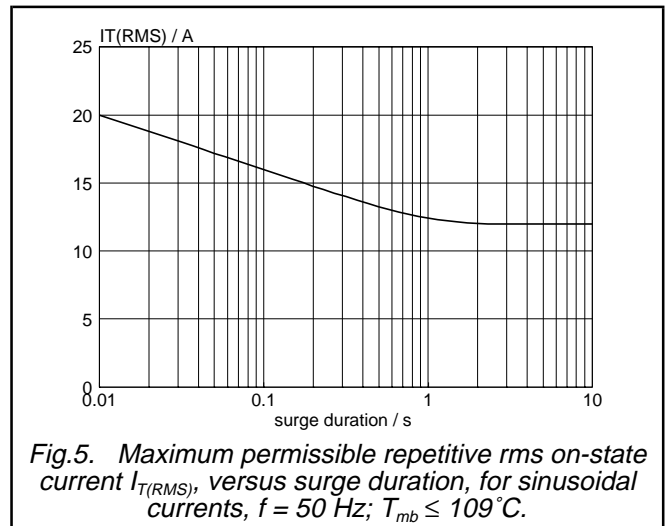

Fig. 5. Maximum permissible repetitive rms on-state current $I_{T(RMS)}$, versus surge duration, for sinusoidal currents, $f = 50 \text{ Hz}$; $T_{mb} \leq 109^\circ \text{C}$.

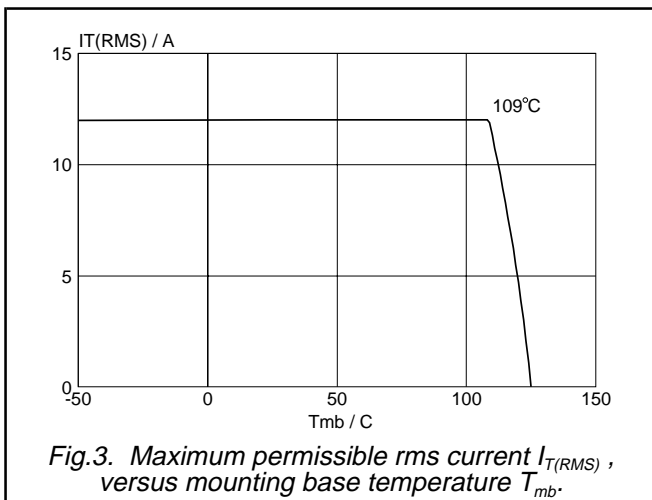

Fig. 3. Maximum permissible rms current $I_{T(RMS)}$, versus mounting base temperature T_{mb} .

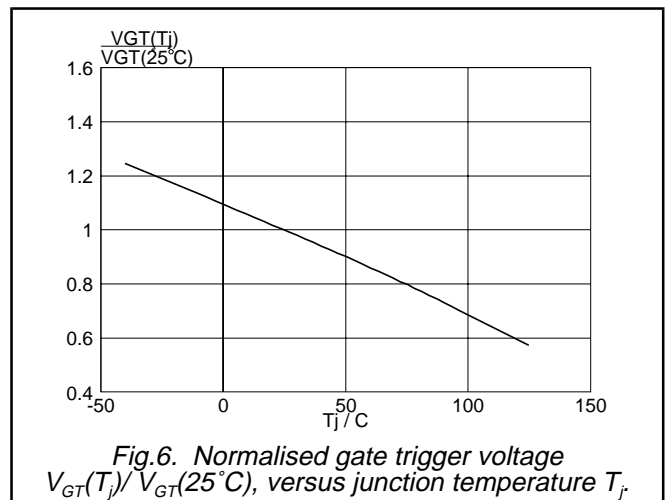
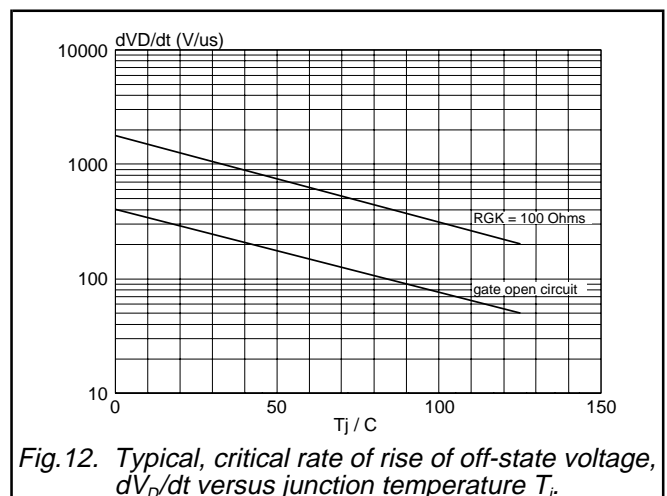
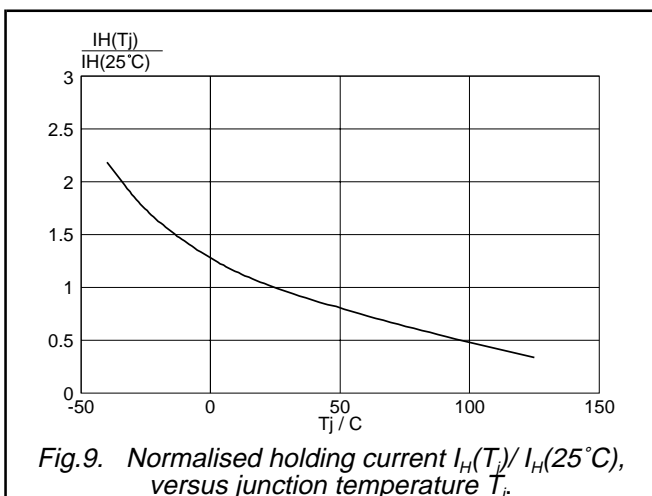
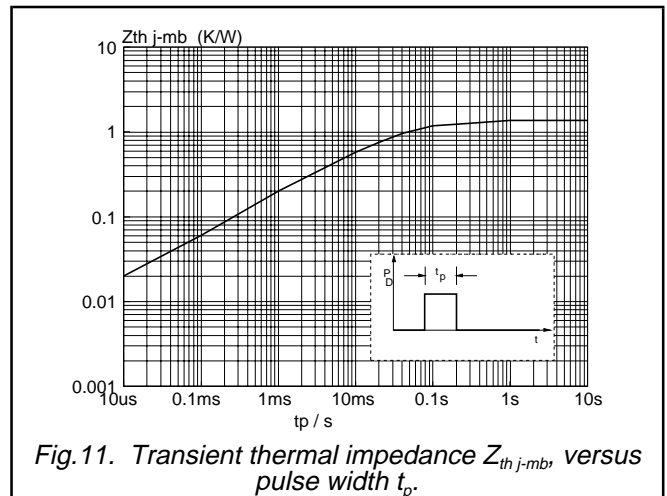
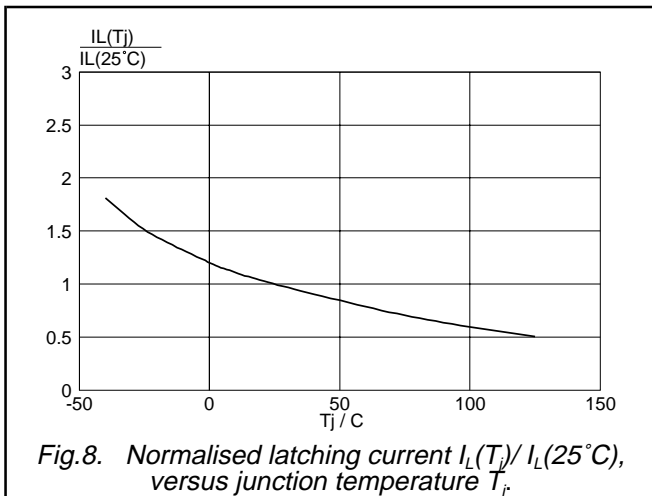
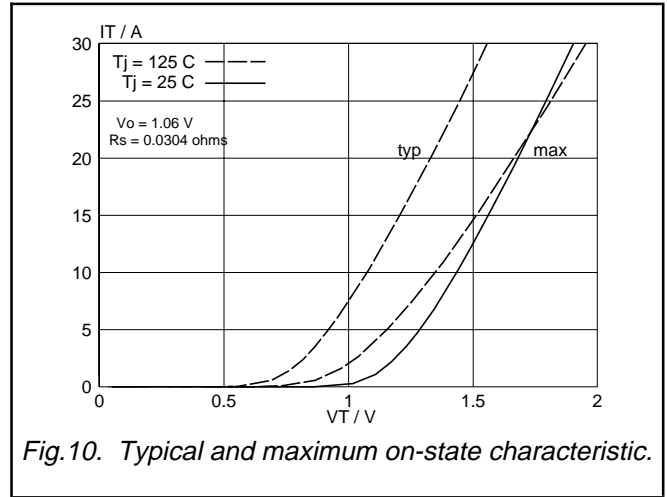
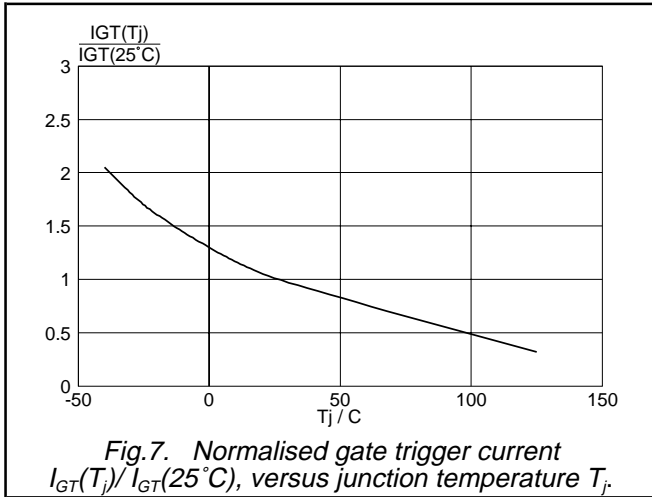

Fig. 6. Normalised gate trigger voltage $V_{GT}(T_j) / V_{GT}(25^\circ \text{C})$, versus junction temperature T_j .

Thyristors

BT151 series



Thyristors

BT151 series

MECHANICAL DATA

Dimensions in mm

Net Mass: 2 g

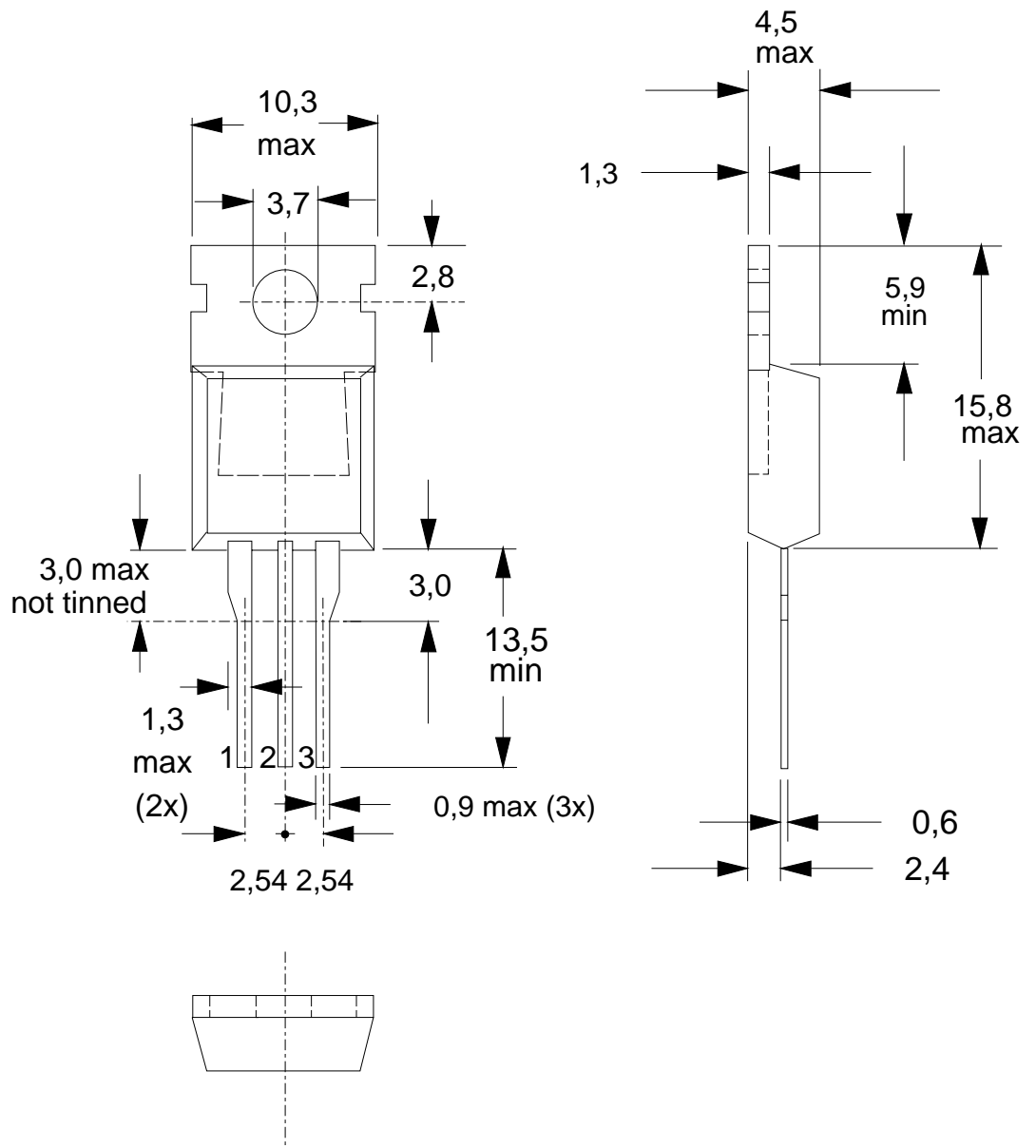

Fig.13. SOT78 (TO220AB). pin 2 connected to mounting base.

Notes

1. Refer to mounting instructions for SOT78 (TO220) envelopes.
2. Epoxy meets UL94 V0 at 1/8".

Thyristors

BT151 series

DEFINITIONS

| | |
|--|---|
| Data sheet status | |
| Objective specification | This data sheet contains target or goal specifications for product development. |
| Preliminary specification | This data sheet contains preliminary data; supplementary data may be published later. |
| Product specification | This data sheet contains final product specifications. |
| Limiting values | |
| Limiting values are given in accordance with the Absolute Maximum Rating System (IEC 134). Stress above one or more of the limiting values may cause permanent damage to the device. These are stress ratings only and operation of the device at these or at any other conditions above those given in the Characteristics sections of this specification is not implied. Exposure to limiting values for extended periods may affect device reliability. | |
| Application information | |
| Where application information is given, it is advisory and does not form part of the specification. | |
| © Philips Electronics N.V. 1999 | |
| All rights are reserved. Reproduction in whole or in part is prohibited without the prior written consent of the copyright owner. | |
| The information presented in this document does not form part of any quotation or contract, it is believed to be accurate and reliable and may be changed without notice. No liability will be accepted by the publisher for any consequence of its use. Publication thereof does not convey nor imply any license under patent or other industrial or intellectual property rights. | |

LIFE SUPPORT APPLICATIONS

These products are not designed for use in life support appliances, devices or systems where malfunction of these products can be reasonably expected to result in personal injury. Philips customers using or selling these products for use in such applications do so at their own risk and agree to fully indemnify Philips for any damages resulting from such improper use or sale.