

# CEP6030L/CEB6030L

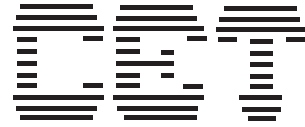

March 1998

4

## N-Channel Logic Level Enhancement Mode Field Effect Transistor

### FEATURES

- 30V , 52A ,  $R_{DS(ON)}=13.5m\Omega$  @  $V_{GS}=10V$ .  
 $R_{DS(ON)}=20m\Omega$  @  $V_{GS}=4.5V$ .
- Super high dense cell design for extremely low  $R_{DS(ON)}$ .
- High power and current handling capability.
- TO-220 & TO-263 package.

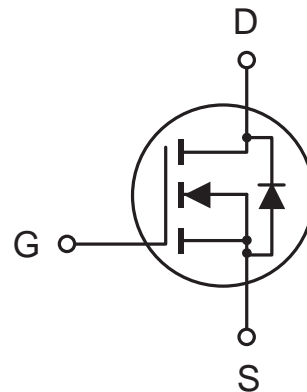

### ABSOLUTE MAXIMUM RATINGS ( $T_C=25^\circ C$ unless otherwise noted)

Parameter	Symbol	Limit	Unit
Drain-Source Voltage	$V_{DS}$	30	V
Gate-Source Voltage	$V_{GS}$	$\pm 16$	V
Drain Current-Continuous @ $T_J=125^\circ C$ -Pulsed	$I_D$	52	A
	$I_{DM}$	156	A
Drain-Source Diode Forward Current	$I_S$	52	A
Maximum Power Dissipation <sup>a</sup> @ $T_C=25^\circ C$ Derate above $25^\circ C$	$P_D$	75	W
		0.5	W/ $^\circ C$
Operating and Storage Temperature Range	$T_J, T_{STG}$	-65 to 175	$^\circ C$

### THERMAL CHARACTERISTICS

Thermal Resistance, Junction-to-Case	$R_{\theta JC}$	2	$^\circ C/W$
Thermal Resistance, Junction-to-Ambient	$R_{\theta JA}$	62.5	$^\circ C/W$

# CEP6030L/CEB6030L

## ELECTRICAL CHARACTERISTICS (Tc=25°C unless otherwise noted)

4

Parameter	Symbol	Condition	Min	Typ <sup>c</sup>	Max	Unit
<b>OFF CHARACTERISTICS</b>						
Drain-Source Breakdown Voltage	BV <sub>DSS</sub>	V <sub>GS</sub> = 0V, I <sub>D</sub> = 250μA	30			V
Zero Gate Voltage Drain Current	I <sub>DSS</sub>	V <sub>DS</sub> = 24V, V <sub>GS</sub> = 0V			1	μA
Gate-Body Leakage	I <sub>GSS</sub>	V <sub>GS</sub> = ±16V, V <sub>DS</sub> = 0V			±100	nA
<b>ON CHARACTERISTICS<sup>a</sup></b>						
Gate Threshold Voltage	V <sub>GS(th)</sub>	V <sub>DS</sub> = V <sub>GS</sub> , I <sub>D</sub> = 250μA	1	1.6	3	V
Drain-Source On-State Resistance	R <sub>DS(ON)</sub>	V <sub>GS</sub> = 10V, I <sub>D</sub> = 26A		11	13.5	mΩ
		V <sub>GS</sub> = 4.5V, I <sub>D</sub> = 21A		16	20.0	mΩ
On-State Drain Current	I <sub>D(ON)</sub>	V <sub>DS</sub> = 10V, V <sub>GS</sub> = 10V	60			A
Forward Transconductance	g <sub>FS</sub>	V <sub>DS</sub> = 10V, I <sub>D</sub> = 26A		32		S
<b>DYNAMIC CHARACTERISTICS<sup>b</sup></b>						
Input Capacitance	C <sub>ISS</sub>	V <sub>DS</sub> = 15V, V <sub>GS</sub> = 0V f = 1.0MHz		1200		pF
Output Capacitance	C <sub>OSS</sub>			480		pF
Reverse Transfer Capacitance	C <sub>RSS</sub>			130		pF
<b>SWITCHING CHARACTERISTICS<sup>b</sup></b>						
Turn-On Delay Time	t <sub>D(ON)</sub>	V <sub>DD</sub> = 15V, I <sub>D</sub> = 52A, V <sub>GS</sub> = 10V R <sub>GEN</sub> = 24Ω		6	16	ns
Rise Time	t <sub>r</sub>			120	250	ns
Turn-Off Delay Time	t <sub>D(OFF)</sub>			40	90	ns
Fall Time	t <sub>f</sub>			105	200	ns
Total Gate Charge	Q <sub>g</sub>	V <sub>DS</sub> = 15V, I <sub>D</sub> = 48A, V <sub>GS</sub> = 5V		19	23	nC
Gate-Source Charge	Q <sub>gs</sub>			5		nC
Gate-Drain Charge	Q <sub>gd</sub>			9		nC

# CEP6030L/CEB6030L

4

## ELECTRICAL CHARACTERISTICS ( $T_C=25^\circ\text{C}$ unless otherwise noted)

Parameter	Symbol	Condition	Min	Typ	Max	Unit
<b>DRAIN-SOURCE DIODE CHARACTERISTICS <sup>a</sup></b>						
Diode Forward Voltage	$V_{SD}$	$V_{GS} = 0V, I_S = 26A$		0.9	1.3	V

Notes

a. Pulse Test: Pulse Width  $\leq 300 \mu s$ , Duty Cycle  $\leq 2\%$ .

b. Guaranteed by design, not subject to production testing.

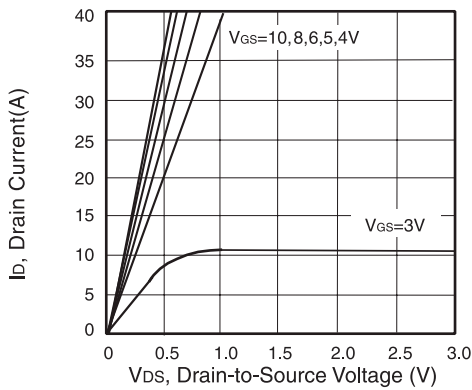

Figure 1. Output Characteristics

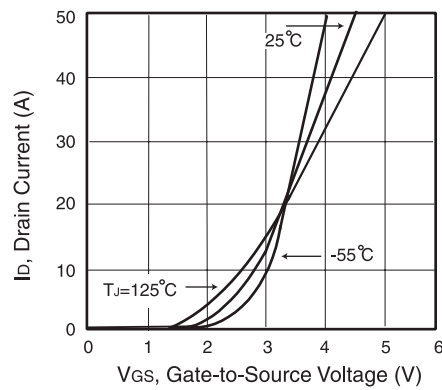

Figure 2. Transfer Characteristics

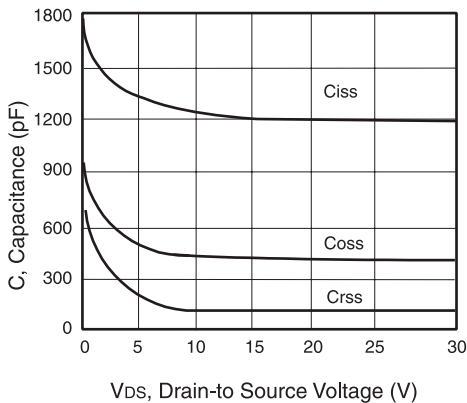

Figure 3. Capacitance

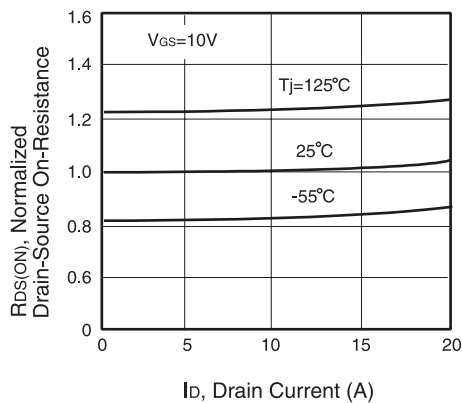

Figure 4. On-Resistance Variation with Drain Current and Temperature

# CEP6030L/CEB6030L

4

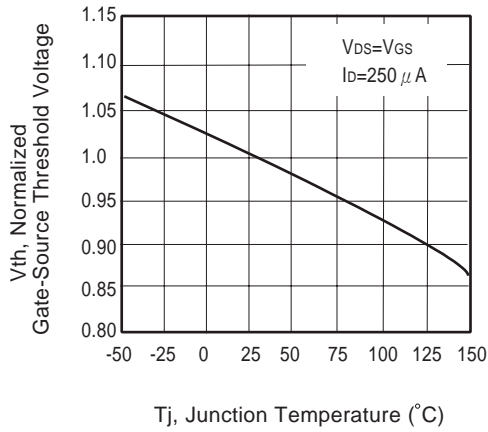

Figure 5. Gate Threshold Variation with Temperature

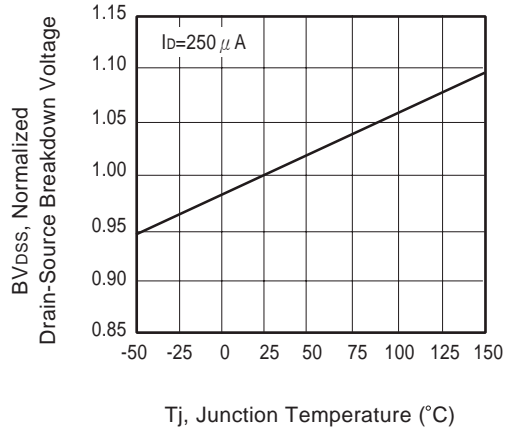

Figure 6. Breakdown Voltage Variation with Temperature

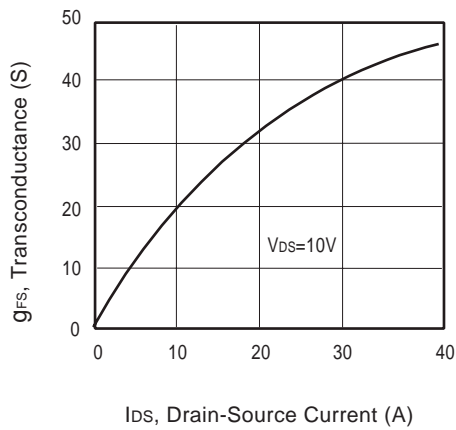

Figure 7. Transconductance Variation with Drain Current

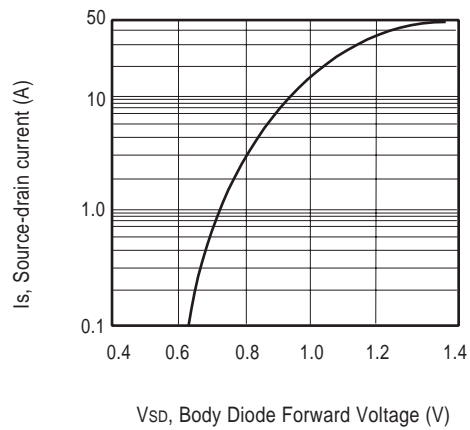

Figure 8. Body Diode Forward Voltage Variation with Source Current

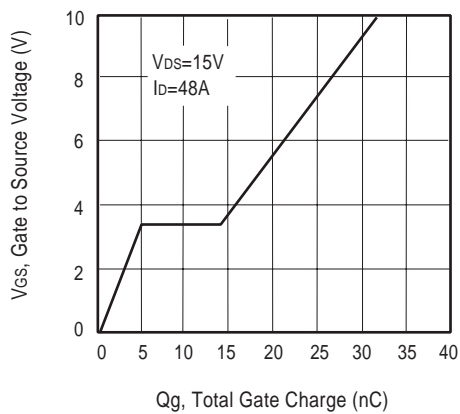

Figure 9. Gate Charge

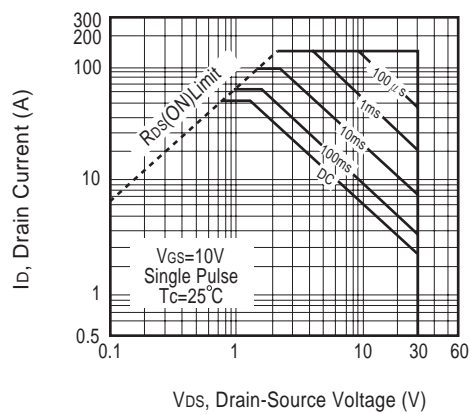

Figure 10. Maximum Safe Operating Area

# CEP6030L/CEB6030L

4

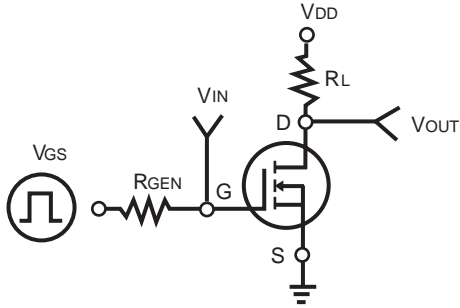

Figure 11. Switching Test Circuit

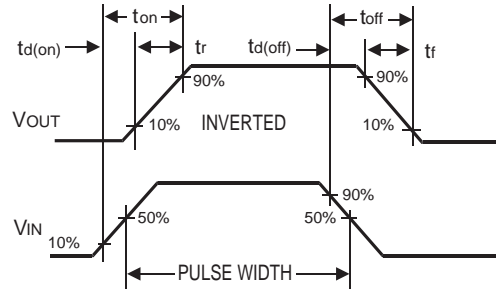

Figure 12. Switching Waveforms

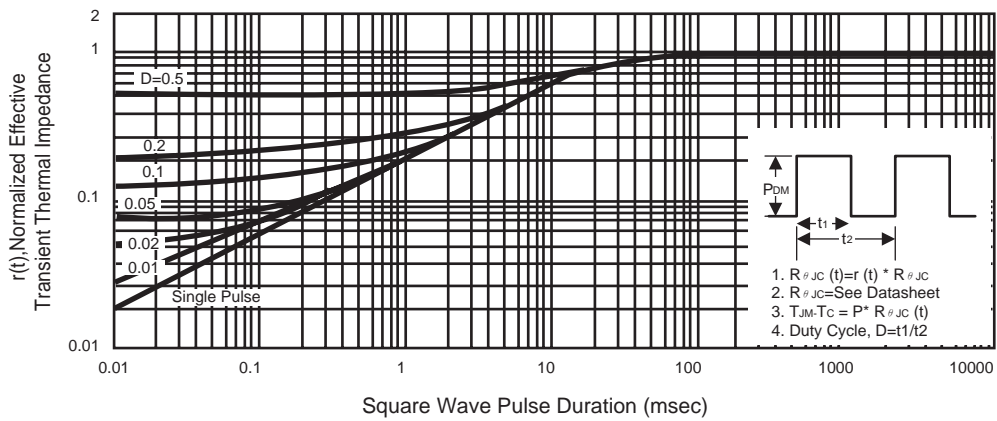

Figure 13. Normalized Thermal Transient Impedance Curve