

EQ 80 Enneode

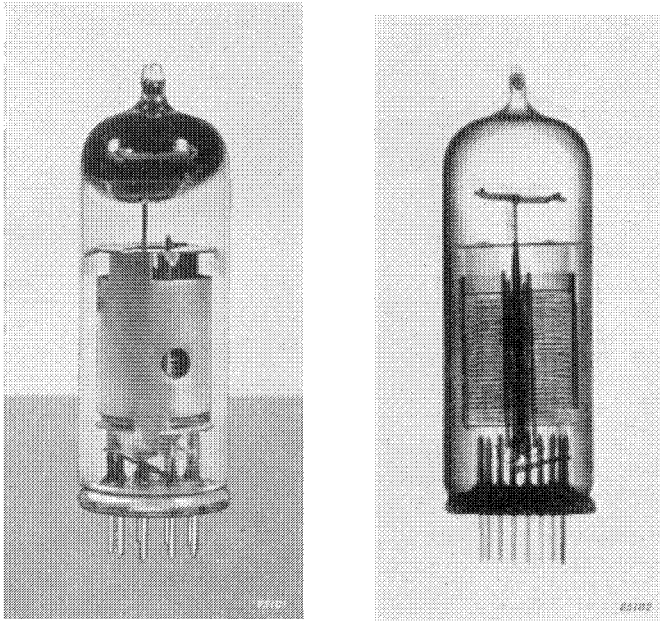

Fig. 1
Normal and X-ray photographs of the EQ 80 (approximately
actual size).

The EQ 80 is an enneode, comprising a cathode, 7 grids and an anode. The fact that some of the grids are interconnected has made it possible to mount the electrode system on a standard Noval base. This valve is intended for use as detector and, at the same time, as amplitude limiter, in F.M. receivers. The principle on which this valve works differs fundamentally from that of all other known systems, in which frequency variations are transformed into amplitude variations for detection in the conventional manner. In the EQ 80, a constant cathode current is influenced by two control grids in such a way that the anode current varies in accordance with the difference in phase between the two control voltages.

In order to give a clear picture of the detection process, it is essential first to describe the design of the valve and the functions of the different grids. The cathode current first passes grid g_1 , which in the F.M. detector is at the same potential as the cathode. The second grid is a screen grid whose potential is roughly 20 V above that of the cathode. Grids g_3 and g_5 are control grids, separated by a screen grid g_4 , which is connected to the other screen grids, g_2 and g_6 . The last grid, g_7 , is a suppressor grid, which gives the

EQ 80

valve the characteristics of a pentode. The electron current is accordingly governed almost exclusively by the voltage on the second grid, assuming a constant voltage on the first grid. The distribution of current among g_2 and the subsequent electrodes is determined by the potentials of the control grids g_3 and g_5 ; as long as g_3 is sufficiently negative, the electrons flow to g_2 , but as soon as it becomes slightly positive, the electrons pass through g_2 . In view of the fact that the cathode current is determined mainly by the screen grid voltage, an increase in the positive potential of g_3 (naturally within limits) has little or no effect on the total flow of current; the same applies to control grid g_5 .

Briefly, then, the electrons reach the anode only if grids 3 and 5 are both positive with respect to the cathode, although the actual values of V_{g3} and V_{g5} have little effect on the value of the cathode current.

When the valve is used as an F.M. detector, the alternating voltages applied to g_3 and g_5 are of like amplitude, but the difference between their respective phase angles is proportional to the frequency variation. At sufficiently high amplitudes, a current will flow in the anode circuit of which the average value is determined by the phase difference between the alternating voltages on g_3 and g_5 .

This may be seen from Fig. 3, in which V_{g3} , V_{g5} and the anode current are reproduced as functions of time. The shaded area *I* represents the waveform of the anode current for a phase difference $\varphi=50^\circ$, *II* for $\varphi=90^\circ$ and *III* for $\varphi=130^\circ$. The trapezoidal form of these areas is due to the fact that the alternating grid voltages do not immediately cause the anode current to rise from 0 to maximum.

Fig. 4 shows the EQ 80 used as an F.M. detector. The two circuits of the

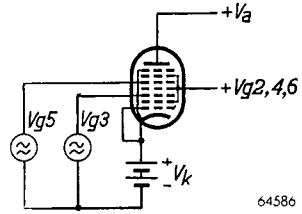

Fig. 2
Control and supply voltages for the EQ 80.

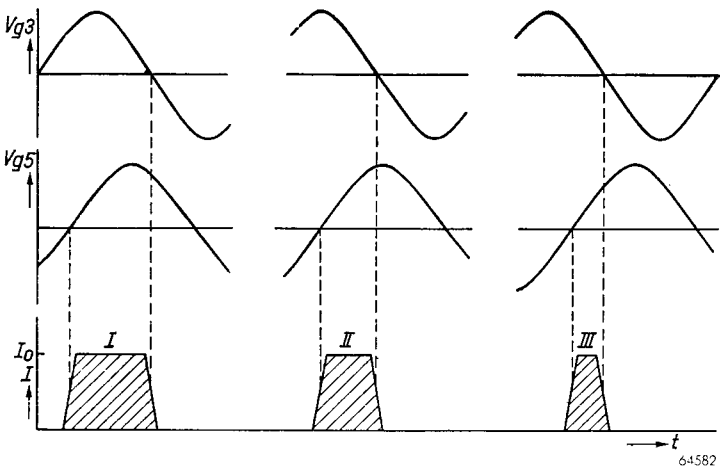

Fig. 3
Alternating input voltages V_{g3} and V_{g5} and average anode current as functions of time.

last I.F. transformer supply the two control voltages; without modulation, these voltages show a phase displacement of 90° , but, with modulation, φ varies in accordance with the frequency variation. This produces an A.F. alternating voltage across the resistor R_4 . The parasitic capacitance in the anode circuit (approx. 25 pF) is in itself sufficient to bypass the high frequency components of the anode current.

Closer investigation now reveals that the variation in φ is not exactly proportional to the frequency shift: the relationship between the phase angle φ and the frequency variation is actually rendered by an arc cot. curve, as depicted in Fig. 5. The figure also shows that the distortion is dependent on the Q of the secondary circuit of the preceding I.F. transformer and on the relative

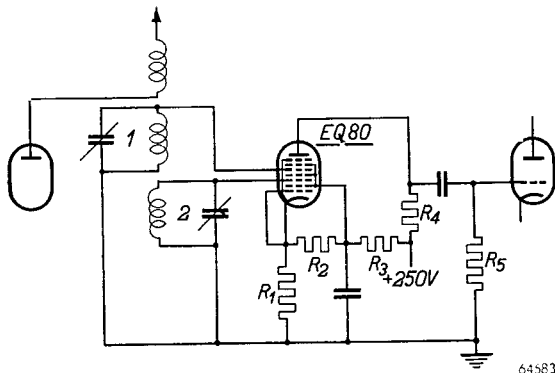

Fig. 4
The EQ 80 used as F.M. detector.

frequency variation. The highest permissible quality factor for the secondary circuit at a given maximum frequency swing can therefore be determined on the basis of the maximum permissible distortion. To give a practical example, let the intermediate frequency f be 10 Mc/s, the max. frequency swing $\Delta f = 75$ kc/s and the permissible distortion 2.5%. In this case, $Q_2 \frac{\Delta f}{f} = 0.3$, yielding a value of 40 for Q_2 . The maximum frequency swing of 75 kc/s occurs only seldom in transmission, however, and an average

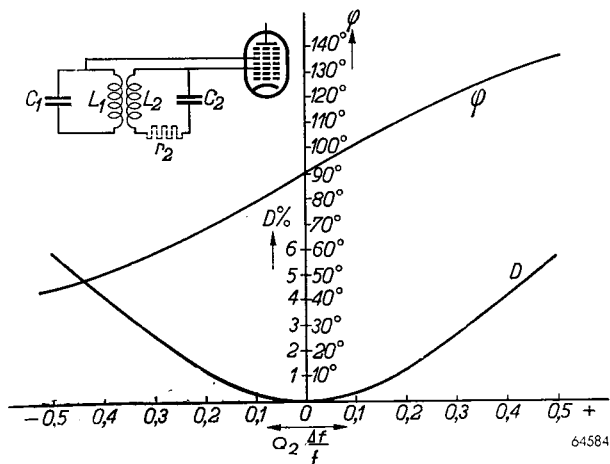

Fig. 5
The phase angle φ and the total distortion D as a function of the relation $Q_2 \Delta f/f$.

EQ 80

variation of not more than 30 kc/s can be safely assumed, the distortion being then very much less.

To avoid detection interference which may be present in the form of amplitude modulation, an amplitude limiter should precede the detector in an F.M. receiver. The EQ 80 automatically functions as such when the alternating input voltages on g_3 and g_5 are at least $8 V_{RMS}$. This is clearly illustrated in Fig. 6, in which the anode current is reproduced as a function of the alternating grid voltage for various values of the phase angle φ between V_{g3} and V_{g5} . At $V_{g3} = V_{g5} = 8 V_{RMS}$ the anode current is indeed almost independent of the alternating grid voltage.

Fig. 7 shows the anode current as a function of the phase angle φ ; the variation in anode current accompanying any given variation in the phase angle can be ascertained from this curve. The average anode current for zero modulation (i.e. $\varphi = 90^\circ$) is 0.28 mA. If the phase angle varies between 60° and 120° , the anode current will vary from 0.35 mA to 0.2 mA. The alternating anode current is therefore

$$\frac{0.35 - 0.2}{2\sqrt{2}} = 0.0537 \text{ mA.}$$

With an optimum load of $0.47 \text{ M}\Omega$ and a $0.7 \text{ M}\Omega$ grid leak for the next, i.e. the output valve, this yields an alternating output voltage of about $15 V_{RMS}$. Considering that the output valve EL 41 is fully loaded on an alternating grid voltage of not more than 5 V, it will be seen that the available output voltage is more than enough, and even provides a small reserve for feedback purposes.

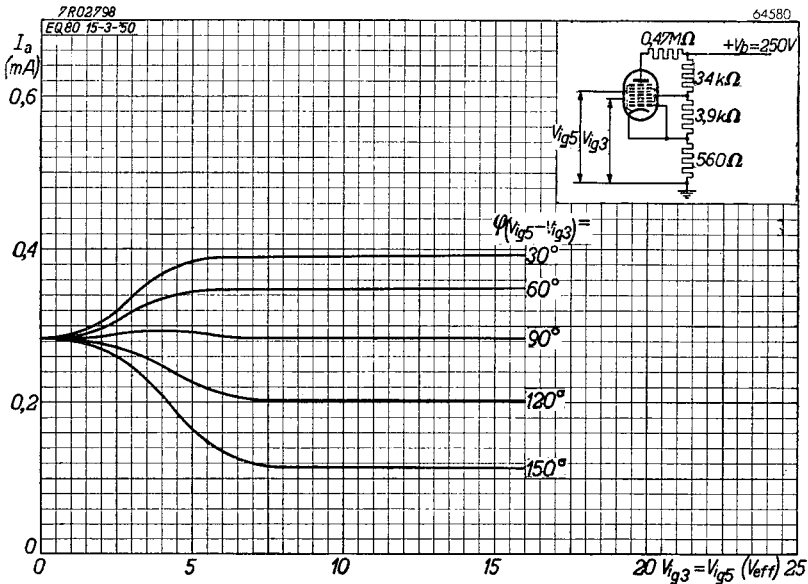

Fig. 6

Anode current of the EQ 80 as a function of the alternating input voltages applied to grids 3 and 5, for different values of the phase angle φ .

An extra pre-amplifier between the EQ 80 and the output valve is therefore not required.

In view of the fact that detection is possible also at the flanks of the discriminator curve, in which range the transmitted signal is usually distorted and the EQ 80 is more sensitive to microphony, it may be advisable to employ an optical tuning indicator and/or "silent tuning" to ensure accurate tuning of the set. This can be done quite simply by using the extra diode, usually available in one of the valves, in the manner shown in Fig. 8 (see also page 435).

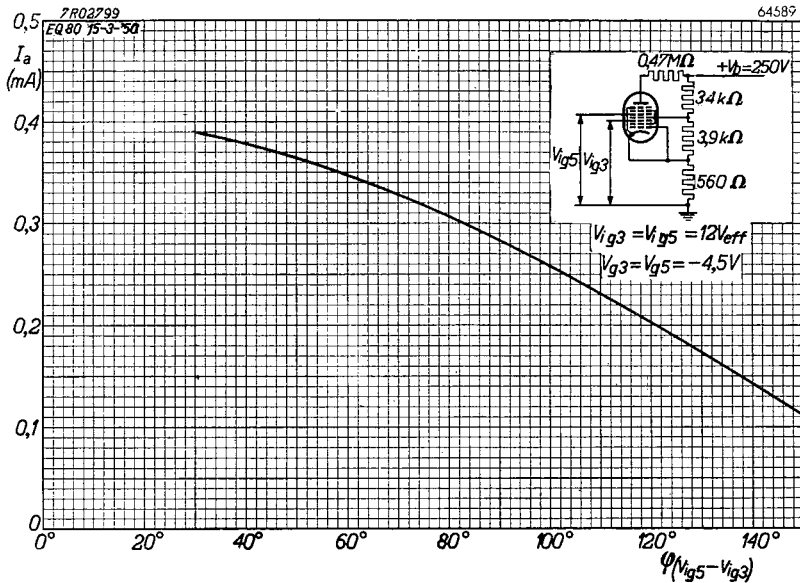

Fig. 7

Anode current of the EQ 80 as a function of the phase angle φ , with $V_{ig5} = V_{ig3} = 12$ V_{RMS}.

The basis of this method is an auxiliary voltage which peaks sharply at the appropriate tuning frequency, this voltage being detected and applied to the tuning indicator, or to a triode providing the silent tuning. Since the selectivity curve of the I.F. transformer has no sharp peak, but is flat-topped, a high-quality circuit (L_4C_4) is coupled to the circuit L_2C_2 by means of an earthed capacitor (C_k).

The voltage across C_4 is rectified by the diode and is applied to the control grid of the triode section of the EM 34; this triode can also be used for the silent tuning.

In the absence of a signal, the grid voltage of the EM 34 is 0 V, and the voltage on the triode anode is 20—30 V, but when the grid becomes negative owing to the rectified signal voltage, the anode voltage rises. A certain proportion of this voltage is applied to the first grid of the EQ 80 by means of R_1 , R_2 .

EQ 80

In the absence of a signal the EQ 80 is biased to cut-off, the F.M. detector being then inoperative, but on reception of a signal, a positive voltage is applied to the first grid of this valve, so that the detector comes into operation when the set is tuned. If the receiver is not fitted with the tuning indicator EM 34, the triode of another valve, say the ECH 42 or ECH 21, can of course be utilized for this purpose. Moreover, the rectified voltage can, if necessary, be taken to the first grid of the EQ 80 without previous amplification.

In A.M./F.M. receivers capable of receiving amplitude-modulated as well as frequency-modulated signals, the EQ 80 may be used as an A.F. pentode for the A.M. signals, the first grid then functioning as control grid, whilst grids 3 and 5 are connected to the screen grids 2, 4 and 6. In this case the sensitivity must be restricted to 25 mV to avoid microphony.

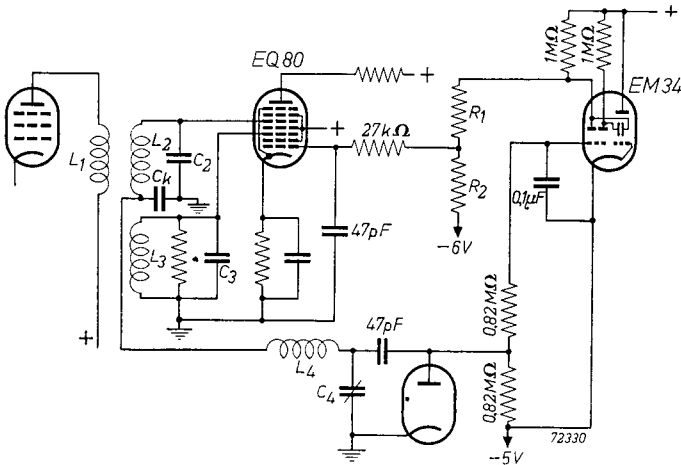

Fig. 8
Circuit of the EQ 80 used as F.M. detector with silent tuning.

TECHNICAL DATA OF THE ENNEODE EQ 80

Heater data

Heating: indirect by A.C. or D.C.; parallel feed
 Heater voltage V_f = 6.3 V
 Heater current I_f = 0.2 A

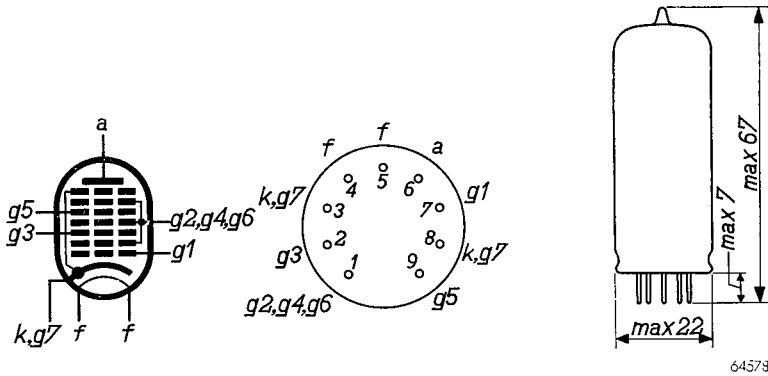

Fig. 9

Electrode arrangement, electrode connections and max. dimensions in mm of the EQ 80.

Capacitances (cold valve)

| | | | |
|-----------------------------------|------------|---|---------|
| Input capacitance grid No. 1 | C_{g1} | = | 4.2 pF |
| Input capacitance grid No. 3 | C_{g3} | = | 5.8 pF |
| Input capacitance grid No. 5 | C_{g5} | = | 8.2 pF |
| Output capacitance | C_a | = | 8.7 pF |
| Anode - grid No. 1 | C_{ag1} | < | 0.4 pF |
| Anode - grid No. 3 | C_{ag3} | < | 0.15 pF |
| Anode - grid No. 5 | C_{ag5} | < | 0.35 pF |
| Grid No. 3 - grid No. 5 | C_{g3g5} | < | 0.4 pF |
| Heater - grid No. 1 | C_{g1f} | < | 0.2 pF |
| Heater - grid No. 3 | C_{g3f} | < | 0.15 pF |
| Heater - grid No. 5 | C_{g5f} | < | 0.15 pF |

Operating characteristics as F.M. detector and amplitude limiter (Fig. 10)

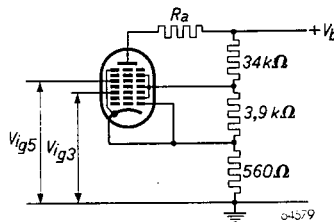

Fig. 10

The EQ 80 used as F.M. detector.

EQ 80

| | | | |
|---|---------------------|---|-----------------|
| Supply voltage | V_b | = | 250 V |
| Screen grid voltage | $V_{g2+g4+g6}$ | = | 20 V |
| Grid bias, grids 3 and 5 | $V_{g3} = V_{g5}$ | = | -4 V |
| Alternating input voltage to grids 3 and 5 | $V_{ig3} = V_{ig5}$ | = | 12 V_{RMS} |
| Phase displacement between alternating input voltages V_{ig3} and V_{ig5} | φ | = | 90 ° |
| Anode resistor | R_a | = | 0.47 M Ω |
| Anode current | I_a | = | 0.28 mA |
| Screen grid current | $I_{g2+g4+g6}$ | = | 1.5 mA |
| Current to grid 3 | I_{g3} | = | 0.09 mA |
| Current to grid 5 | I_{g5} | = | 0.03 mA |
| Internal resistance | R_i | = | 5 M Ω |

No special measures need be taken to avoid microphony if the alternating input voltage to the next valve is at least 1 V_{RMS} for an output power of 50 mW.

Operating characteristics as A.F. amplifier (Fig. 11)

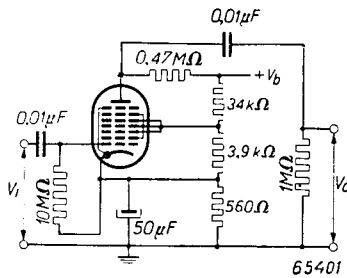

Fig. 11
The EQ 80 used as A.F. amplifier.

| | | | |
|---|-------------|---|---------|
| Supply voltage | V_b | = | 250 V |
| Anode current | I_a | = | 0.28 mA |
| Total distortion with an alternating output voltage of 15 V_{RMS} | d_{tot} | = | 2.8 % |
| Amplification | V_o / V_i | = | 150 |

Limiting values

| | | | |
|--|-----------|--------|-------|
| Anode voltage, valve biased to cut-off | V_{a_o} | = max. | 550 V |
| Anode voltage | V_a | = max. | 300 V |

| | | |
|---|---|---|
| Anode dissipation | W_a | = max. 0.1 W |
| Screen grid voltage, valve biased to cut-off | $V_{(g2+g4+g6)_0}$ | = max. 250 V |
| Screen grid voltage | $V_{g2+g4+g6}$ | = max. 100 V |
| Screen grid dissipation | $W_{g2+g4+g6}$ | = max. 0.1 W |
| Cathode current | I_k | = max. 3 mA |
| Grid current starting point | $V_{g1}(I_{g1} = +0.3 \mu A)$ $V_{g3}(I_{g3} = +0.3 \mu A)$ $V_{g5}(I_{g5} = +0.3 \mu A)$ | = max. -1.3 V = max. -1.3 V = max. -1.3 V |
| External resistance, grid 1 to cathode | R_{g1} | = max. 1 MΩ* |
| External resistance, grid 3 to cathode | R_{g3} | = max. 3 MΩ |
| External resistance, grid 5 to cathode | R_{g5} | = max. 3 MΩ |
| External resistance, heater to cathode | R_{fk} | = max. 20 kΩ |
| Voltage between heater and cathode | V_{fk} | = max. 100 V |

*) If the working point of the valve is determined only by the voltage drop across the grid leak, the maximum value for R_{g1} may be increased to 22 MΩ. A maximum of 1 MΩ is applicable only if a cathode resistor is used.

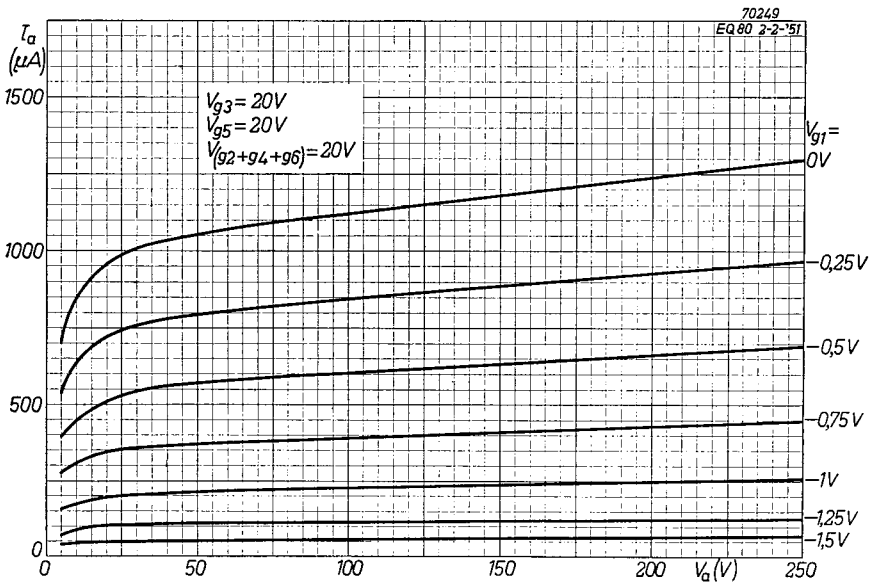

Fig. 12

Anode current as a function of the anode voltage, with V_{g1} as parameter.

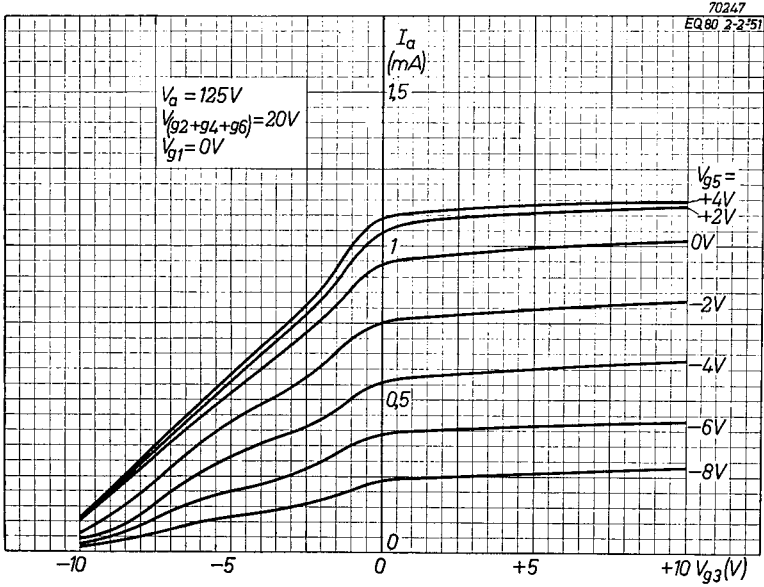

Fig. 13
Anode current as a function of the voltage on grid 3, with V_{g_5} as parameter.

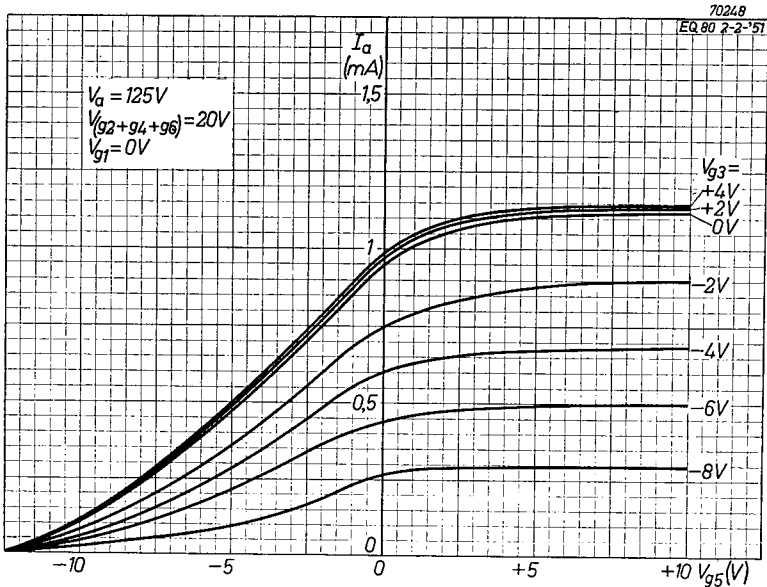

Fig. 14
Anode current as a function of the voltage on grid 5, with V_{g_3} as parameter.