

PFC control IC FA1A60N

LLC current resonant control IC FA6B20N

Power supply design example : 180W Reference Design

1. Overview

This document describes the design example of LLC converter using PFC IC FA1A60N and LLC IC FA6B20N. The input is universal (90Vac to 264Vac) and the output is 180W.

To ensure high reliability of the power supply, the capacitive mode prevention function, high-accuracy overload protection function and overcurrent protection function with adjustable delay time are provided. In addition, efficiency at light load is improved with low standby mode, therefore auxiliary power supply for standby can be removed. Auto standby operation and Standby operation by external signal are selectable by mode selection function. When it is used with Fuji CRM PFC control IC "FA1A60N", FA6B20N controls PFC IC operating mode (continuous, burst or stop operation). It helps to improve efficiency of PSU, optimize the PFC operation and reduce external components.



2. Features

◆ FA6B20N

- The integrated startup circuit achieves downsized power supply and lower power consumption.
- Operating mode can be switched between normal operation mode and low standby mode.
- "Auto standby operation" and "Standby operation by external signal" are selectable.
- During the low standby mode, standby power is lowered by the burst mode operation.
- Integrated input filter X-capacitor discharge function decreases loss due to discharge resistance.
- Low consumption current, 0.80mA (Vcc quiescent current).
- Integrated high-side and low-side drive circuits, which can be directly connected to the power MOSFET and operates with 50% duty cycle.
- Various protection functions: overcurrent (IS pin), overload (CA,FB pin), overvoltage (VCC pin), overheat and protection by external signal (MODE pin).
- Integrated level-fixed brown-in/out function (VH pin)
- Various mode selection settings can be made: overcurrent protection (detection by IS pin) delay time setting, operation setting in standby mode, and adjusting output power switching to standby mode.
- Under voltage lock out function (VCC,VB pin)
- Package: SOP-16 (compliant with JEDEC)

◆ FA1A60N

- Operating mode can be switched between burst mode and normal mode by communication signal from "FA6B20N". It helps to improve light load efficiency.
- Combining with "FA6B20N", operation is optimized according to line voltage and distortion of line current is improved for wide input voltage range.
- Low standby power due to no input voltage detection resistors
- High-precision over current protection: $0.6V \pm 2\%$
- Improved power efficiency at light load by frequency reduction
- Reduced audio noise at start up by overshoot reduction and dynamic OVP
- Low current consumption by CMOS process,
- Start-up: 250 μ A(typ.), Operating: 0.8mA(typ.)
- Drive circuit for power MOSFET, peak current: source 500mA, sink 1000mA
- Protects the output electrolytic capacitor by the double OVP function, even if a fault happen in the output detection.
- Short protection at feedback (FB) pin
- Under-voltage Lockout
- Restart timer
- 8-pin package (SOP)

3. Application circuit

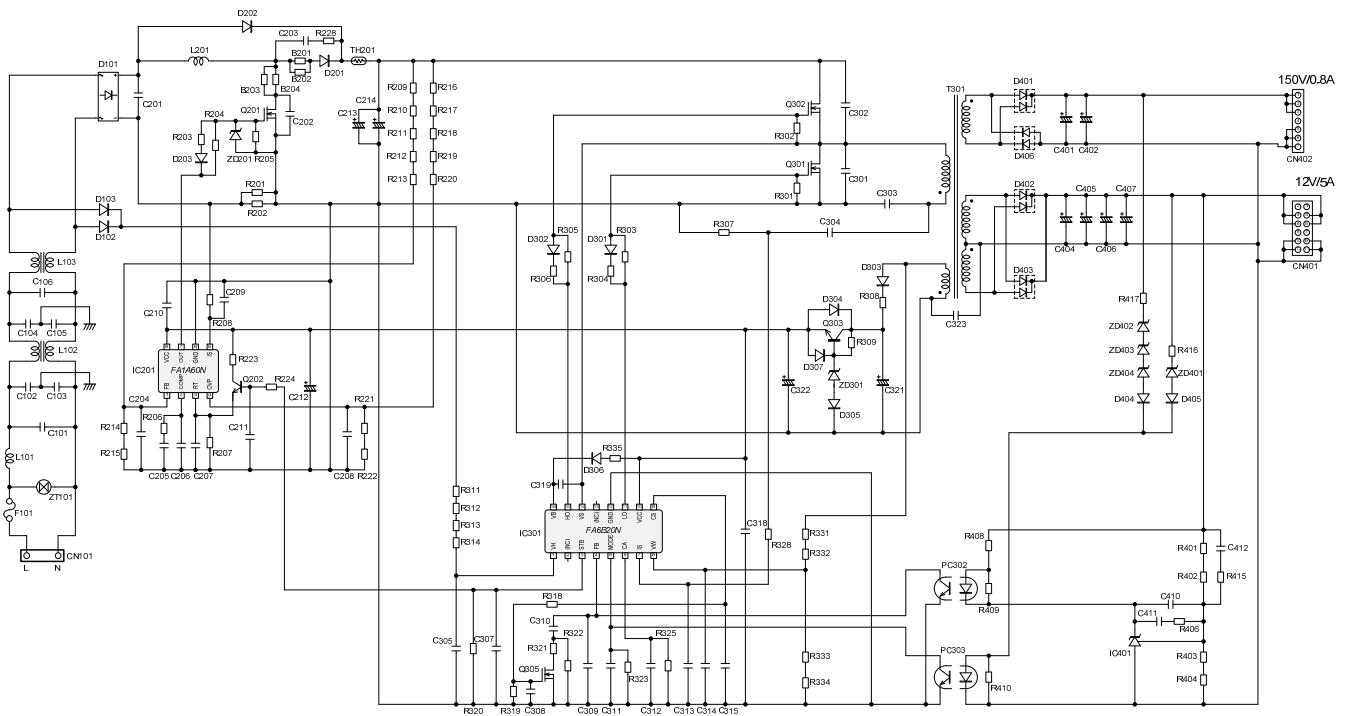

4. Specifications of the power supply

Item	Value	Unit
Input voltage	90 to 264	Vac
Output1	Voltage	12
	Current	5
Output2	Voltage	150
	Current	0.8

5. Characteristics

Item		110Vac	230Vac
Efficiency	Typ Load(180W)	89.7%	92.0%
	Light Load(5W)	79.5%	81.9%
Input power	Po=120mW	257mW	249mW
OLP		275W	

6. Characteristics curves

◆ EFFICIENCY

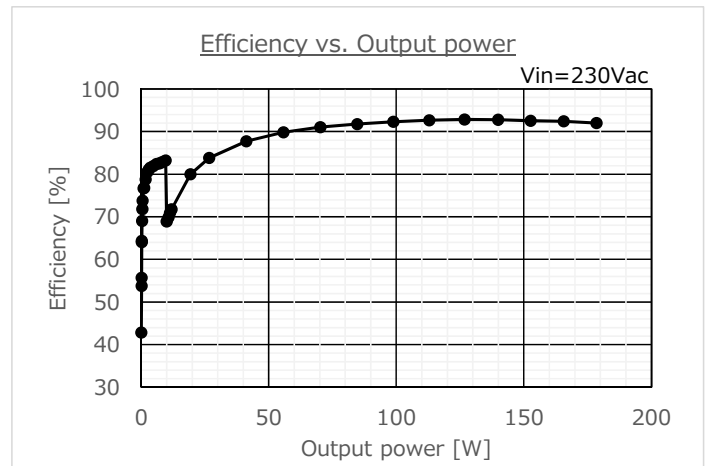
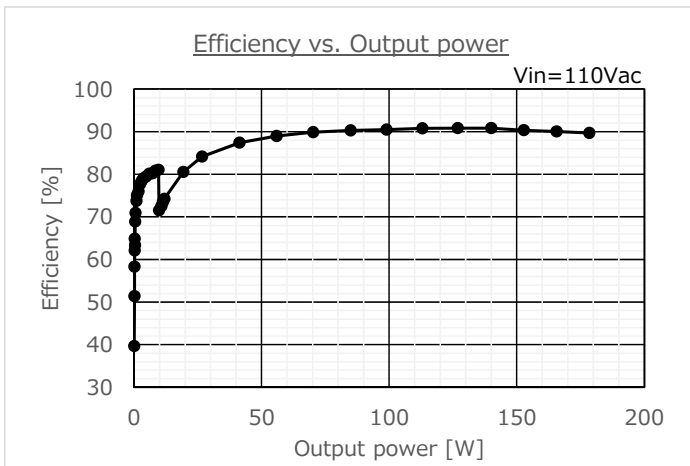
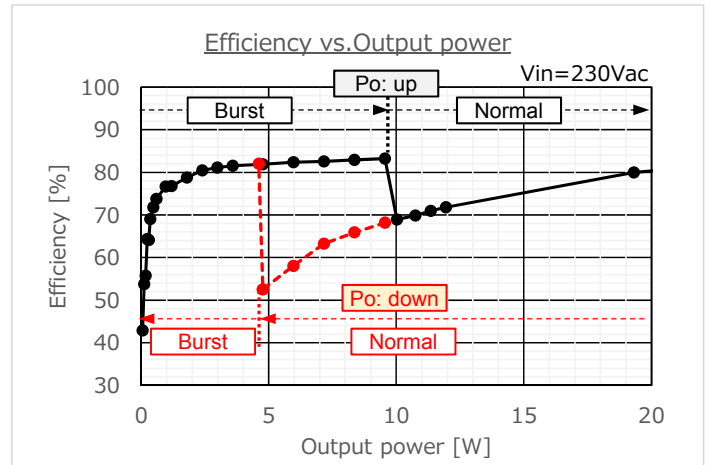
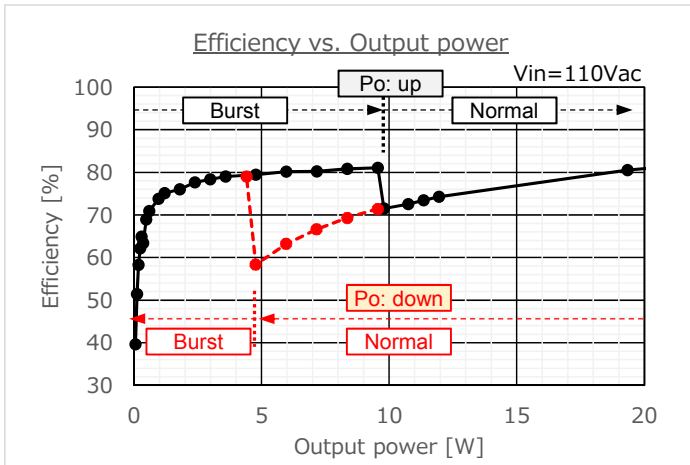

◆ INPUT POWER OF LIGHT LOAD

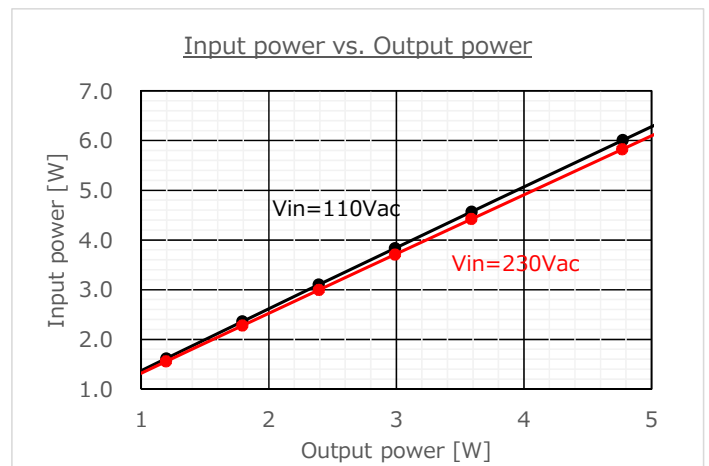
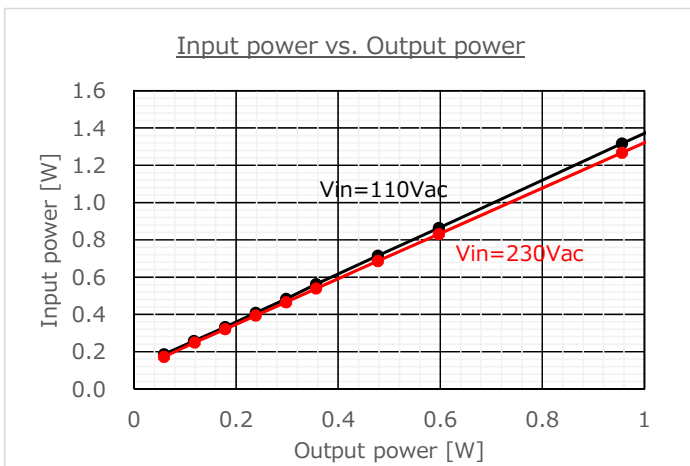

◆ CROSS REGULATION

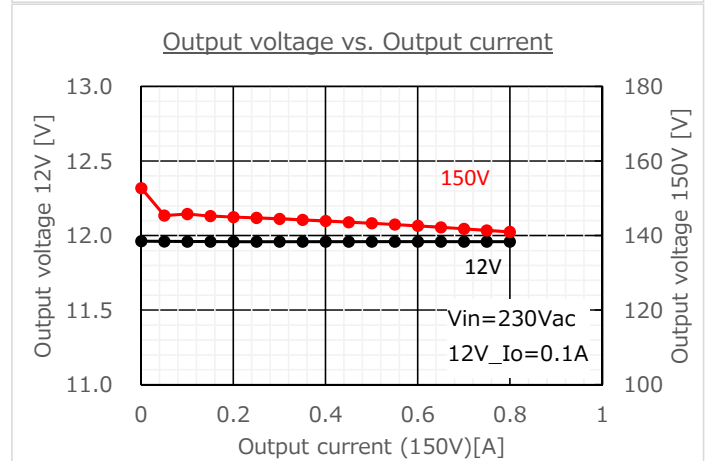
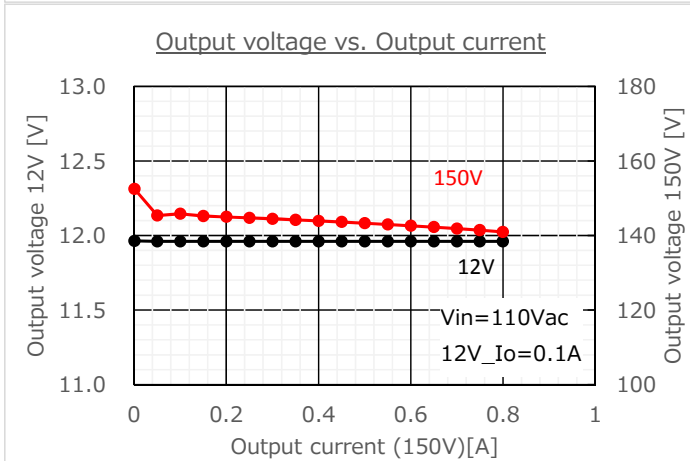
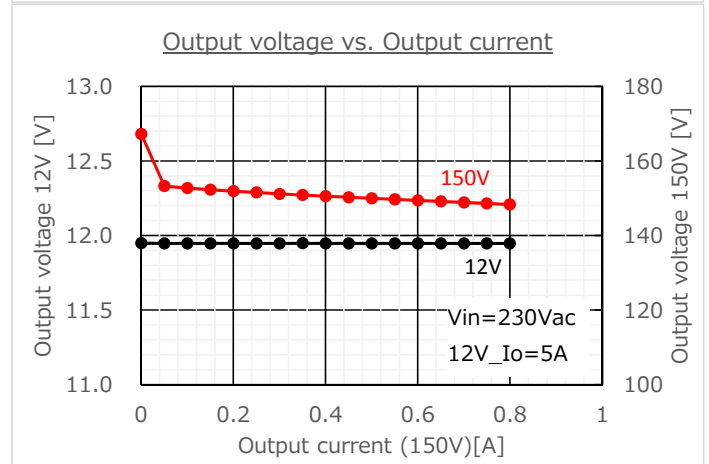
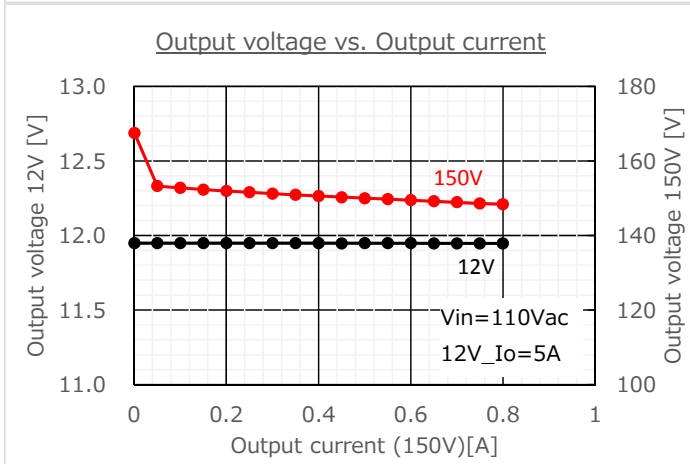
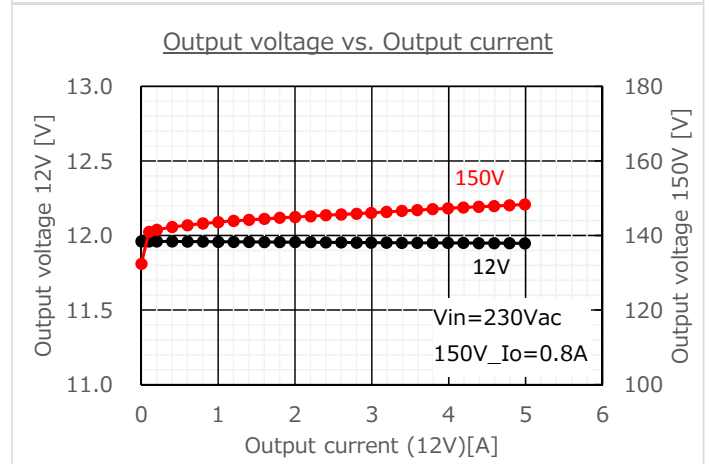
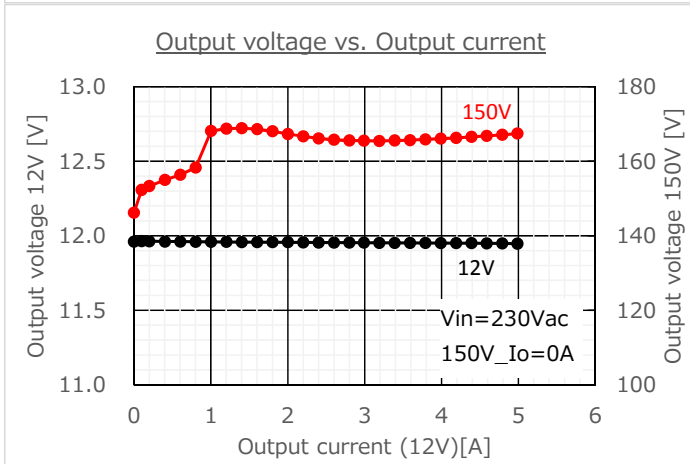
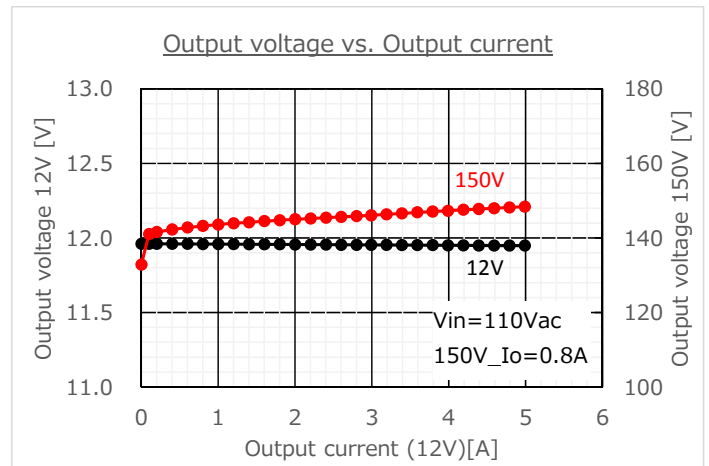
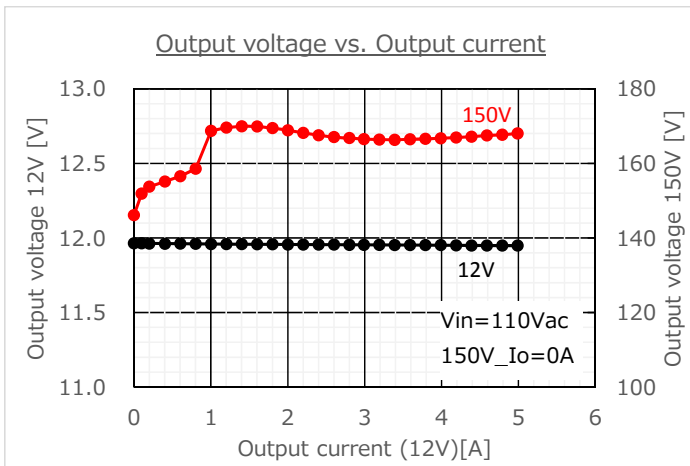

◆ LINE REGULATION

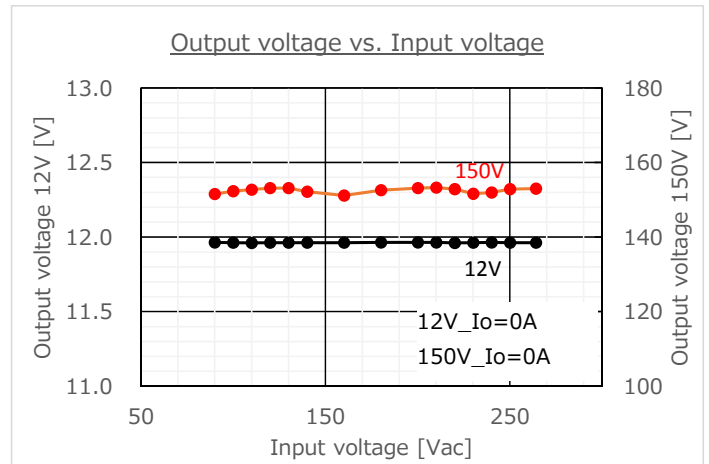
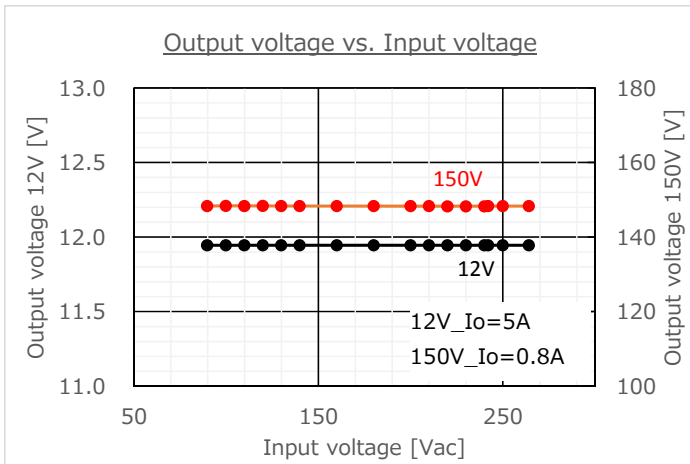

◆ POWER FACTOR

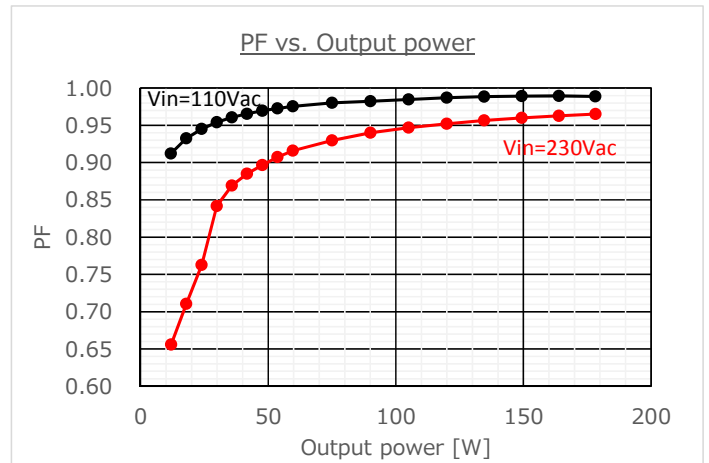
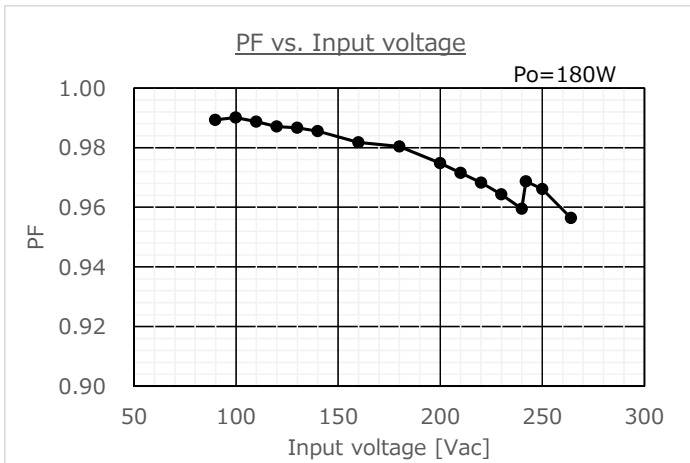

7. LLC OPERATION WAVEFORM

◆ SWITCHING WAVEFORM (Po=180W)

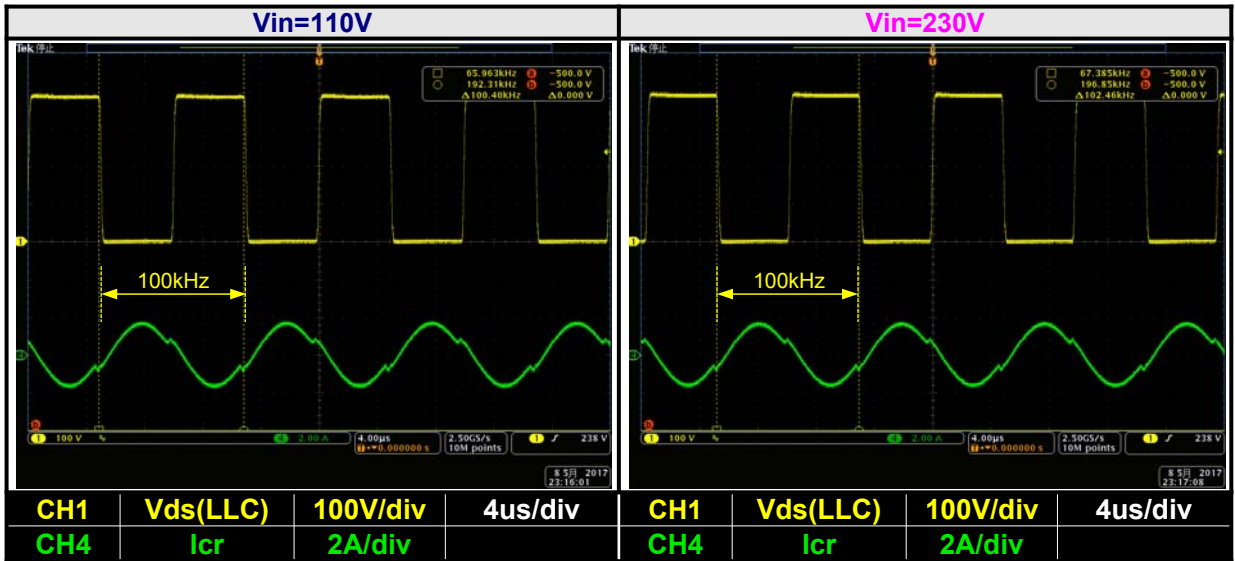

◆ SWITCHING WAVEFORM (Po=3.6W)

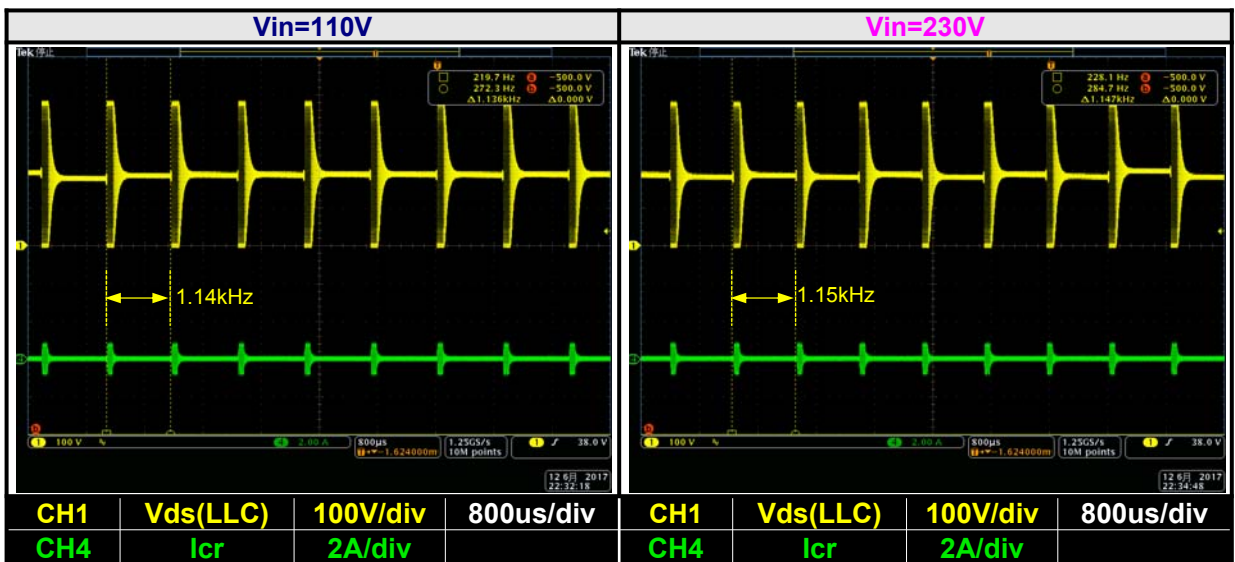

◆ SWITCHING WAVEFORM (Po=0.12W)

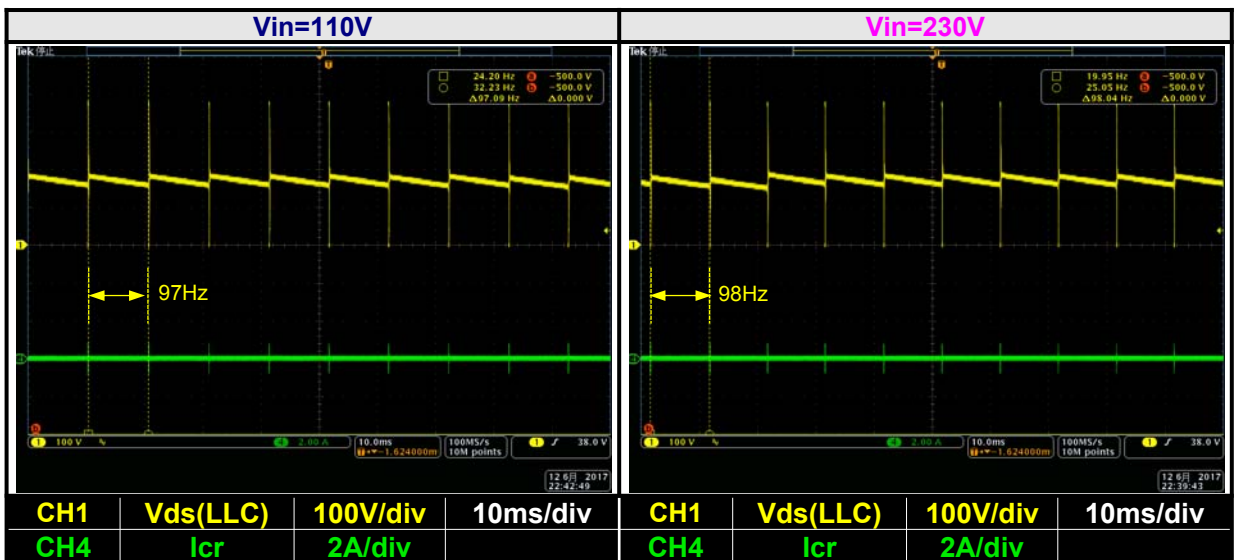

8. PFC OPERATION WAVEFORM

◆ **INPUT CURRENT (Po=180W)**

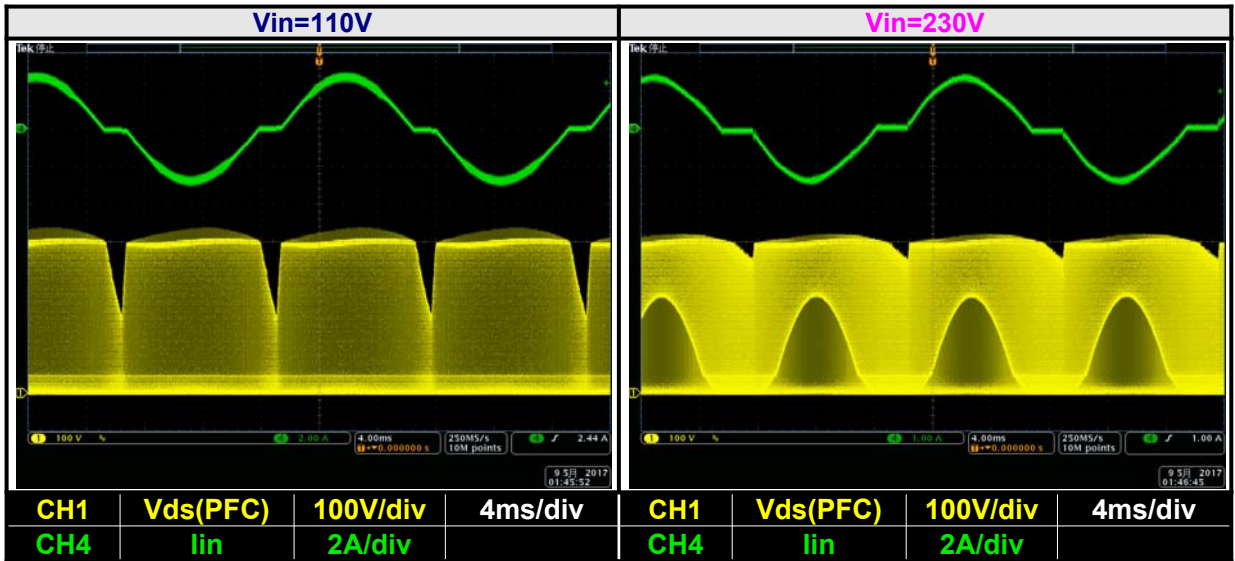

◆ **PFC OUTPUT VOLTAGE (Po=3.6W)**

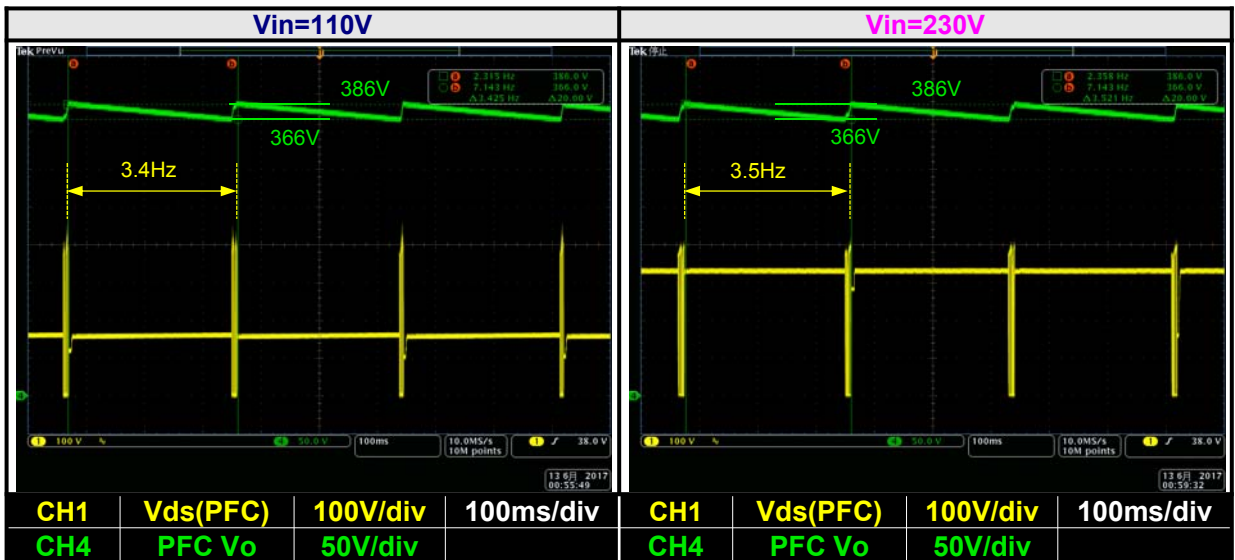

◆ **PFC OUTPUT VOLTAGE (Po=0.12W)**

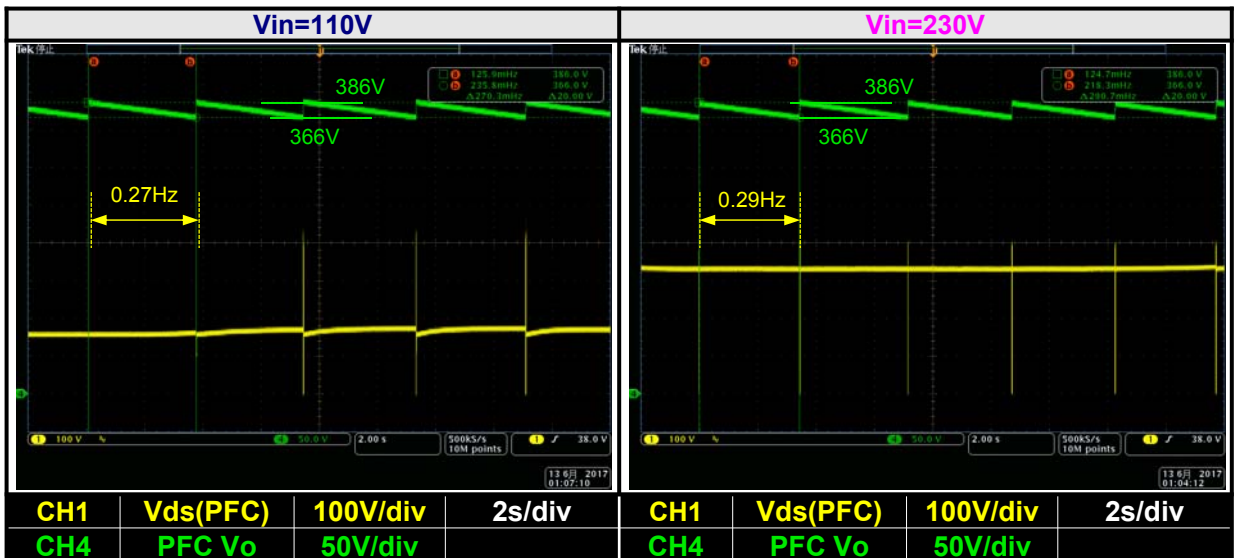

9. START-UP WAVEFORM (Po=160W)

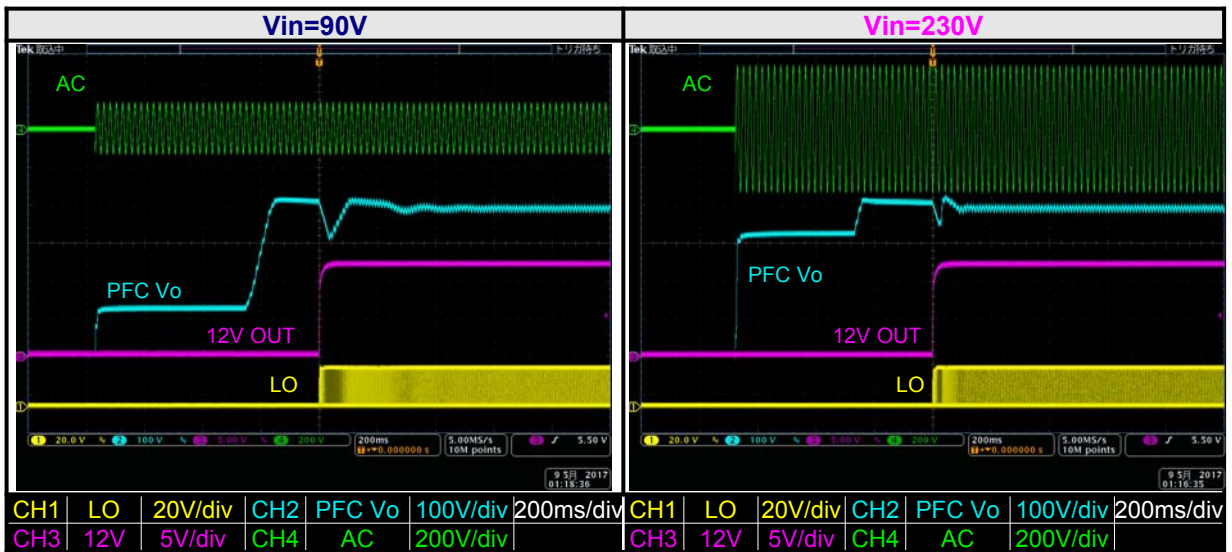

10. OUTPUT VOLTAGE OF LIGHT LOAD

◆ 12V OUTPUTVOLTAGE (Po=3.6W)

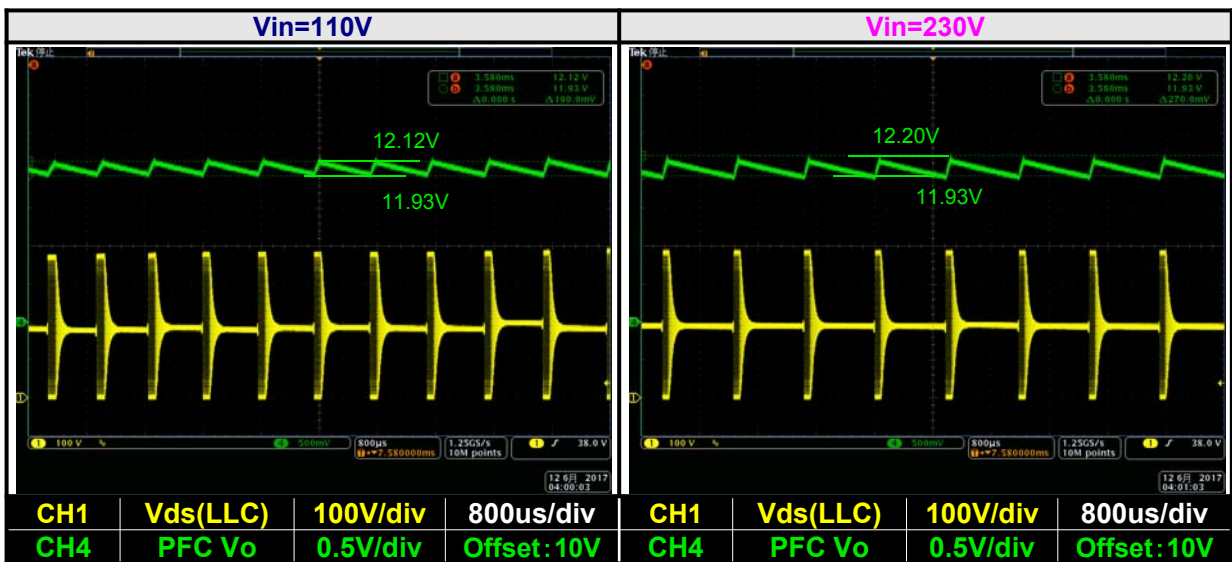

◆ 12V OUTPUTVOLTAGE (Po=0.12W)

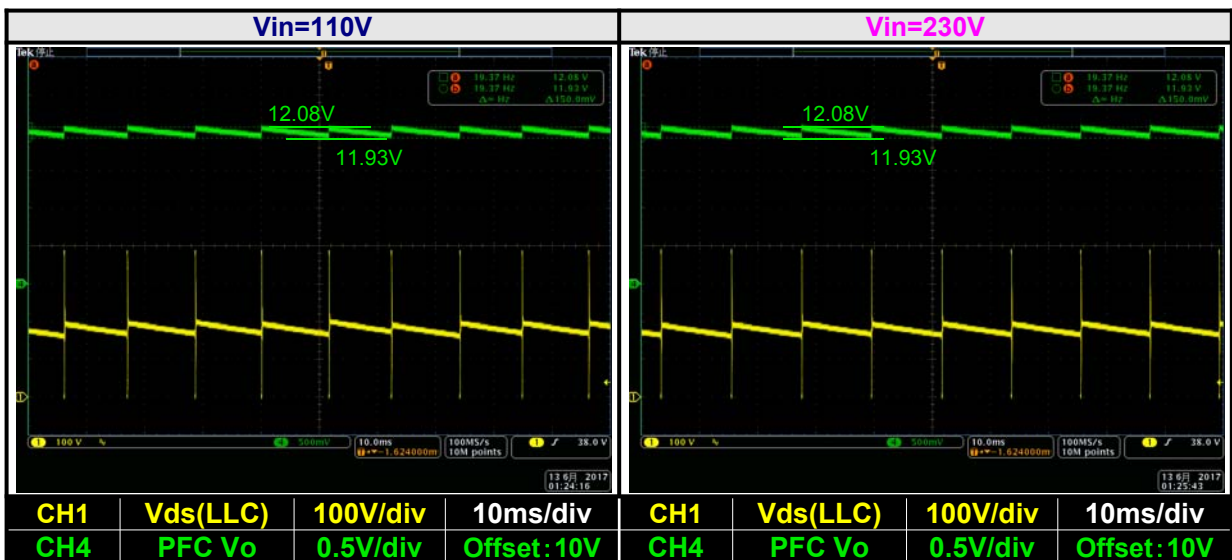

FA1A60N/FA6B20N Reference Design
11. Bill of material

Component	Item	Value	Part. No	Maker	Note
IC201	PFC IC		FA1A60N	Fuji	
IC301	LLC IC		FA6B20N	Fuji	
IC401	Regulator IC		RT9H301C-T122-1	Isahaya	
Q201	MOSFET		FMW60N190S2HF	Fuji	HETA SINK
Q202	Transistor	50V,0.2A			
Q301,302	MOSFET		FMD60N380S2HF	Fuji	
Q303	Transistor	100V,0.5A			
Q305	MOSFET	50V,0.1A			
D101	Diode Bridge		D15JAB60V-7000	SHINDENGEN	HETA SINK
D102,103	Diode	600V,1A	D1N60-5070	SHINDENGEN	
D201	Diode		YG972S6R	Fuji	HETA SINK
D202	Diode		UF5406-E3	VISHAY	
D203	Diode	200V,1A	CRH01	Toshiba	
D301,302	Diode	200V,1A	CRH01	Toshiba	
D303	Diode		ERB91-02	Fuji	
D304,305,307	Diode	200V,1A	CRH01	Toshiba	
D306	Diode		STTH1R06RL	ST micro	
D401	Diode		FCF10A40	Kyocera	HETA SINK
D406	Diode		FRF10A40	Kyocera	HETA SINK
D402,403	Diode		YG862C04R	Fuji	HETA SINK
D404,405	Diode	80V,0.1A	1SS400TE61	RHOM	
ZD201	Zener Diode	200mW,30V	UDZVTE-1730B	RHOM	
ZD301	Zener Diode	200mW,20V	UDZVTE-1720B	RHOM	
ZD401	Zener Diode	200mW,16V	UDZVTE-1716B	RHOM	
ZD402~404	Zener Diode	200mW,75V	MM3Z75VC	Fairchild	
PC302,303	Photo Coupler		TLP781F(GR,F)	Toshiba	
T310	Transformer	Lp=700uH	SP17002-05-01C		
L101	Noise filter	4A,40uH	IDB-T05-25	SEKISHIN	
L102,103	Noise filter	6mH,3A	SFC-1910C-03602-Y	SEKISHIN	
L201	Inductor	180uH	SP16026-5-1B		
B201~204	Bead		HF70BB2.5*2.2*0.8	TDK	
C101,106	Film capacitor	310V,0.22uF	LE224-MX	OKAYA	
C102~105	Ceramic capacitor		CD12-E2GA222MYGSA	TDK	
C201	Film capacitor	450V,1uF	ECWF2W105KA	Panasonic	
C202,203	Ceramic capacitor	1KV,220pF	CK45-R3AD221K-VRA	TDK	
C301,304	Ceramic capacitor	1KV,220pF	CK45-R3AD221K-VRA	TDK	
C305	Ceramic capacitor	1KV,220pF	CK45-R3AD221K-VRA	TDK	
C303	Film capacitor	800VDC,18nF	ECWH8183HA	Panasonic	
C323	Ceramic capacitor		DE1B3KX471KA4BL01	MURATA	
C204	Ceramic capacitor	1000pF			
C205	Ceramic capacitor	0.47uF			
C206	Ceramic capacitor	0.1uF			
C207	Ceramic capacitor	10nF			
C208	Ceramic capacitor	1000pF			
C209	Ceramic capacitor	2200pF			
C210	Ceramic capacitor	0.1uF			
C211	Ceramic capacitor	1000pF			
C212	Electrolytic capacitor	50V,47uF	50ME47AX	SUNCON	
C213,214	Electrolytic capacitor	450V,82uF	UPZ2W820MHD6	nichicon	
C307	Ceramic capacitor	1000pF			
C308	Ceramic capacitor	1000pF			
C309	Ceramic capacitor	1000pF			
C310	Ceramic capacitor	0.47uF			
C311	Ceramic capacitor	10nF			
C312	Ceramic capacitor	0.47uF			
C313	Ceramic capacitor	100pF			
C314	Ceramic capacitor	N.C			
C315	Ceramic capacitor	4700pF			
C318	Ceramic capacitor	0.1uF			
C319	Ceramic capacitor	0.1uF			

FA1A60N/FA6B20N Reference Design

Component	Item	Value	Part. No	Maker	Note
C321,322	Electrolytic capacitor	50V,47uF	50ME47AX	SUNCON	
C401,402	Electrolytic capacitor	350V,10uF	350ME10FH	SUNCON	
C404~406	Electrolytic capacitor	25V,470uF	25ME470WA	SUNCON	
C410	Ceramic capacitor	N.C			
C411	Ceramic capacitor	0.1uF			
C412	Ceramic capacitor	0.1uF			
R201,201	Metal oxide resistor	2W,0.15Ω	MOSX2C R15J	KOA	
R203	Chip Resistor	22Ω			
R204	Chip Resistor	100Ω			
R205	Chip Resistor	47Ω			
R206	Chip Resistor	12kΩ			
R207	Chip Resistor	68kΩ			
R208	Resistor	47Ω			
R209~213	Chip Resistor	3.3MΩ			
R214	Chip Resistor	100kΩ			
R215	Chip Resistor	6.8kΩ			
R216~220	Chip Resistor	3.3MΩ			
R221	Chip Resistor	100kΩ			
R222	Chip Resistor	0Ω			
R223	Chip Resistor	10kΩ			
R224	Chip Resistor	1kΩ			
R228	Jumper	0Ω			
R301,302	Chip Resistor	47kΩ			
R303,305	Chip Resistor	100Ω			
R304,306	Chip Resistor	22Ω			
R307	Chip Resistor	75Ω			
R308	Chip Resistor	0Ω			
R309	Chip Resistor	1kΩ			
R311~314	Chip Resistor	2.4kΩ			
R318	Chip Resistor	1MΩ			
R319	Chip Resistor	2.2MΩ			
R320	Chip Resistor	300kΩ			
R321	Chip Resistor	1kΩ			
R322	Chip Resistor	12kΩ			
R323	Chip Resistor	36kΩ			
R325	Chip Resistor	N.C			
R328	Chip Resistor	100Ω			
R331	Chip Resistor	15kΩ			
R332	Chip Resistor	2.2kΩ			
R333,334	Chip Resistor	1kΩ			
R325	Chip Resistor	2.2Ω			
R401	Chip Resistor	18kΩ			
R402	Chip Resistor	20kΩ			
R403	Chip Resistor	10kΩ			
R404	Chip Resistor	0Ω			
R406	Chip Resistor	47kΩ			
R408	Chip Resistor	3.3kΩ			
R409,410	Chip Resistor	1kΩ			
R416,417	Chip Resistor	2.2kΩ			
ZT101	Surge Absorber		TND14V-471KB00AAA0		
F101	Fuse	250V 5A			
TH101	Power Thermistor	10Ω,4A	10D2-13	SEMITEC	
CN101	AC INLET				
CN401	Connector		DF11-12DP-2DS(24)	HRS	
CN401	Connector		S07B-PASK-2	JST	

12.PFC Coil specification

Winding order	layer	Wire type	turn	Pin	
				Start	Finish
1	N1	2UEW 0.2/20	19	1	3

core	ATQ32/13
inductance	1pin to 3pin 150uH

13.LLC transformer specification

Winding order	layer	Wire type	turn	Pin	
				Start	Finish
1	NP1	Litz Wire UEW 0.12/18 × 2	38	3	4
2	Nvcc	TEX φ0.2	3	2	1

1	NS2	USTC 0.1/35	2	9	10
2	NS3	USTC 0.1/35	2	11	12
3	NS1	USTC 0.1/30	24	5	8
4	NS4	USTC 0.1/35	2	9	10
5	NS5	USTC 0.1/35	2	11	12

Note: NS2, NS3 are bifilar winding

core	EE5214
inductance	3pin to 4pin 700uH
Leakage inductance	3pin to 4pin 102uH

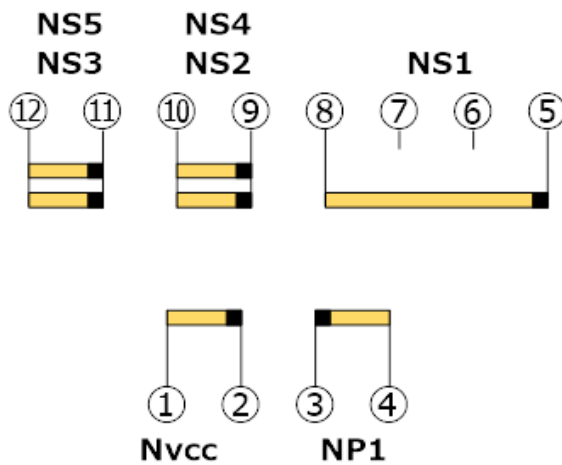

Notice

1. The contents of this note (Product Specification, Characteristics, Data, Materials, and Structure etc.) were prepared in Mar, 2019. The contents will subject to change without notice due to product specification change or some other reasons. In case of using the products stated in this document, the latest product specification shall be provided and the data shall be checked.
2. The application examples in this note show the typical examples of using Fuji products and this note shall neither assure to enforce the industrial property including some other rights nor grant the license.
3. Fuji Electric Co., Ltd. is always enhancing the product quality and reliability. However, semiconductor products may get out of order in a certain probability. Measures for ensuring safety, such as redundant design, spreading fire protection design, malfunction protection design shall be taken, so that Fuji Electric semiconductor product may not cause physical injury, property damage by fire and social damage as a result.
4. Products described in this note are manufactured and intended to be used in the following electronic devices and electric devices in which ordinary reliability is required:
 - Computer - OA equipment - Communication equipment (Pin) - Measuring equipment
 - Machine tool - Audio Visual equipment - Home appliance - Personal equipment
 - Industrial robot etc.
5. Customers who are going to use our products in the following high reliable equipments shall contact us surely and obtain our consent in advance. In case when our products are used in the following equipment, suitable measures for keeping safety such as a back-up-system for malfunction of the equipment shall be taken even if Fuji Electric semiconductor products break down:
 - Transportation equipment (in-vehicle, in-ship etc.) - Communication equipment for trunk line
 - Traffic signal equipment - Gas leak detector and gas shutoff equipment
 - Disaster prevention/Security equipment - Various equipment for the safety.
6. Products described in this note shall not be used in the following equipments that require extremely high reliability:
 - Space equipment - Aircraft equipment - Atomic energy control equipment
 - Undersea communication equipment - Medical equipment.
7. When reprinting or copying all or a part of this note, our company's acceptance in writing shall be obtained.
8. If obscure parts are found in the contents of this note, contact Fuji Electric Co., Ltd. or a sales agent before using our products. Fuji Electric Co., Ltd. and its sales agents shall not be liable for any damage that is caused by a customer who does not follow the instructions in this cautionary statement.

- The contents will subject to change without notice due to product specification change etc.
- Application examples and component in this sheet is for the purpose of assisting in the design. Therefore, This sheet has not been made in consideration of the margin.
- Before using, Please design in consideration of the parts variation and use condition.