

# Green Mode Power Switch

## FSL206MR

### Description

The FSL206MR integrated Pulse-Width Modulator (PWM) and SENSEFET® is specifically designed for high-performance offline Switched-Mode Power Supplies (SMPS) while minimizing external components. This device integrates high-voltage power regulators that combine an avalanche-rugged SENSEFET with a Current-Mode PWM control block.

The integrated PWM controller includes: a 7.8 V regulator, eliminating the need for auxiliary bias winding; Under-Voltage Lockout (UVLO) protection; Leading-Edge Blanking (LEB); an optimized gate turn-on/turn-off driver; EMI attenuator; Thermal Shutdown (TSD) protection; temperature-compensated precision current sources for loop compensation; soft-start during startup; and fault-protection circuitry such as Overload Protection (OLP), Over-Voltage Protection (OVP), Abnormal Over-Current Protection (AOCP), and Line Under-Voltage Protection (LUVP).

The internal high-voltage startup switch and the Burst-Mode operation with very low operating current reduce the power loss in Standby Mode. As a result, it is possible to reach a power loss of 150 mW with no bias winding and 25 mW (for FSL206MR) or 30 mW (for FSL206MRBN) with a bias winding under no-load conditions when the input voltage is 265 Vac.

### Features

- Internal Avalanche-Rugged SENSEFET 650 V
- Precision Fixed Operating Frequency: 67 kHz
- No-Load < 150 mW at 265 Vac without Bias Winding; < 25 mW with Bias Winding for FSL206MR, < 30 mW with Bias Winding for FSL206MRBN
- No Need for Auxiliary Bias Winding
- Frequency Modulation for Attenuating EMI
- Line Under-Voltage Protection (LUVP)
- Pulse-by-Pulse Current Limiting
- Low Under-Voltage Lockout (UVLO)
- Ultra-Low Operating Current: 300 µA
- Built-In Soft-Start and Startup Circuit
- Various Protections: Overload Protection (OLP), Over-Voltage Protection (OVP), Thermal Shutdown (TSD), Abnormal Over-Current Protection (AOCP) Auto-Restart Mode for All Protections

### Applications

- SMPS for STB, DVD & DVCD Players
- SMPS for Auxiliary Power

### Related Resources

- <https://www.onsemi.com/PowerSolutions/home.do>
- <https://www.onsemi.com/pub/Collateral/AN-4137.pdf.pdf>
- <https://www.onsemi.com/pub/Collateral/AN-4141.pdf.pdf>
- <https://www.onsemi.com/pub/Collateral/AN-4150.pdf.pdf>



ON Semiconductor®

[www.onsemi.com](http://www.onsemi.com)

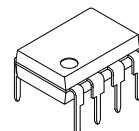

PDIP8 9.42x6.38, 2.54P  
CASE 646CM

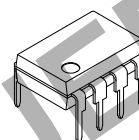

PDIP8 9.59x6.6, 2.54P  
CASE 646CN

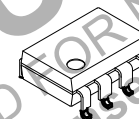

PDIP8 GW  
CASE 709AJ

### MARKING DIAGRAM

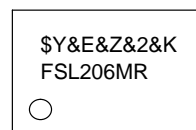

- \$Y = ON Semiconductor Logo
- &E = Designated Space
- &Z = Assembly Plant Code
- &2 = 2-Digit Date code format
- &K = 2-Digits Lot Run Traceability Code
- FSL206MR = Specific Device Code Data

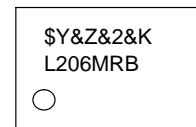

- \$Y = ON Semiconductor Logo
- &Z = Assembly Plant Code
- &2 = 2-Digit Date code format
- &K = 2-Digits Lot Run Traceability Code
- L206MRB = Specific Device Code Data

### ORDERING INFORMATION

See detailed ordering and shipping information on page 2 of this data sheet.

# FSL206MR

## ORDERING INFORMATION

Part Number	Operating Temperature	Top Mark	PKG	Packing Method	Output Power Table (Note 1)			
					Current Limit	$R_{DS(ON),MAX}$	230 Vac $\pm 15\%$ (Note 2)	85 -265 Vac
							Open Frame (Note 3)	Open Frame (Note 3)
FSL206MRN	-40 ~ 115°C	FSL206MR	8-DIP	Tube	0.6 A	19 $\Omega$	12 W	7 W
FSL206MRBN		L206MRB						
FSL206MRL		FSL206MR	8-LSOP	Tube	0.6 A	19 $\Omega$		
FSL206MRLX				Tape & Reel				

1. The junction temperature can limit the maximum output power.
2. 230 Vac or 100/115 Vac with doubler. The maximum power with CCM operation.
3. Maximum practical continuous power in an open-frame design at 50°C ambient.

## APPLICATION DIAGRAM

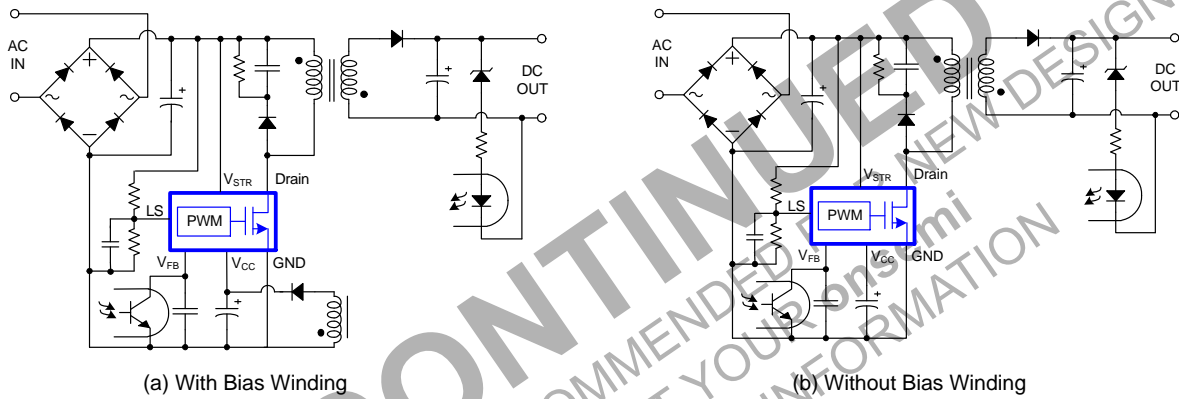

Figure 1. Typical Application

## INTERNAL BLOCK DIAGRAM

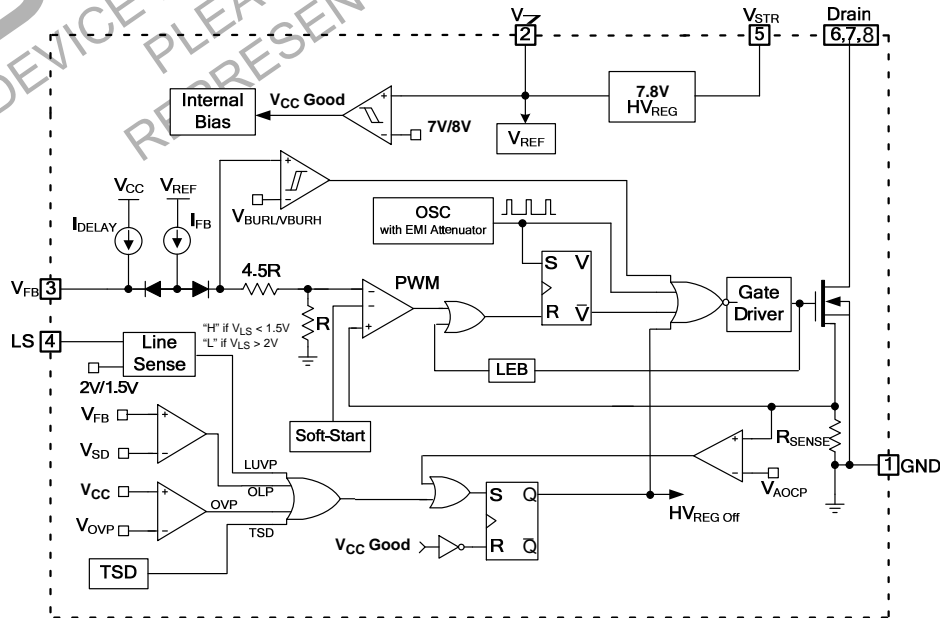

Figure 2. Internal Block Diagram

# FSL206MR

## PIN CONFIGURATION

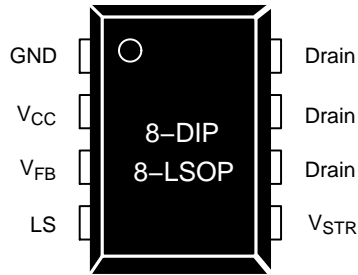

Figure 3. Pin Configuration

### PIN DEFINITIONS

Pin No.	Name	Description
1	GND	<b>Ground.</b> SENSEFET source terminal on the primary side and internal control ground.
2	VCC	<b>Positive Supply Voltage Input.</b> Although connected to an auxiliary transformer winding, current is supplied from pin 5 ( $V_{STR}$ ) via an internal switch during startup (see Figure 2). Once $V_{CC}$ reaches the UVLO upper threshold (12 V), the internal startup switch opens and device power is supplied via the auxiliary transformer winding.
3	VFB	<b>Feedback Voltage.</b> Non-inverting input to the PWM comparator, with a 0.11 mA current source connected internally and a capacitor and opto-coupler typically connected externally. There is a delay while charging external capacitor $C_{FB}$ from 2.4 V to 5 V using an internal 2.7 $\mu$ A current source. This delay prevents false triggering under transient conditions, but allows the protection mechanism to operate under true overload conditions.
4	LS	<b>Line Sense Pin</b> This pin is used to protect the device when the input voltage is lower than the rated input voltage range. If this pin is not used, connect to ground.
5	VSTR	<b>Startup.</b> Connected to the rectified AC line voltage source. At startup, the internal switch supplies internal bias and charges an external storage capacitor placed between the $V_{CC}$ pin and ground. Once $V_{CC}$ reaches 8 V, all internal blocks are activated. After that, the internal high-voltage regulator (HV REG) turns on and off irregularly to maintain $V_{CC}$ at 7.8 V.
6, 7, 8	Drain	<b>Drain.</b> Designed to connect directly to the primary lead of the transformer and capable of switching a maximum of 650 V. Minimizing the length of the trace connecting these pins to the transformer decreases leakage inductance.

# FSL206MR

## ABSOLUTE MAXIMUM RATINGS (T<sub>A</sub> = 25°C unless otherwise specified)

Symbol	Parameter	Min	Max	Unit
V <sub>STR</sub>	V <sub>STR</sub> Pin Voltage	-0.3	650	V
V <sub>DS</sub>	Drain Pin Voltage	-0.3	650	V
V <sub>CC</sub>	Supply Voltage	-	26	V
V <sub>LS</sub>	LS Pin Voltage	-	Internally Clamped Voltage (Note 4)	V
V <sub>FB</sub>	Feedback Voltage Range	-0.3	Internally Clamped Voltage (Note 4)	V
I <sub>DM</sub>	Drain Current Pulsed (Note 5)	-	1.5	A
E <sub>AS</sub>	Single-Pulsed Avalanche Energy (Note 6)	-	11	mJ
P <sub>D</sub>	Total Power Dissipation	-	1.3	W
T <sub>J</sub>	Operating Junction Temperature	-40	+150	°C
T <sub>A</sub>	Operating Ambient Temperature	-40	+125	°C
T <sub>STG</sub>	Storage Temperature	-55	+150	°C
ESD	Human Body Model, JESD22-A114	-	4	kV
	Charged Device Model, JESD22-C101	-	2	

Stresses exceeding those listed in the Maximum Ratings table may damage the device. If any of these limits are exceeded, device functionality should not be assumed, damage may occur and reliability may be affected.

4. V<sub>FB</sub> is clamped by internal clamping diode (13 V I<sub>CLAMP\_MAX</sub> < 100 μA). After Shutdown, before V<sub>CC</sub> reaching V<sub>STOP</sub>, V<sub>SD</sub> < V<sub>FB</sub> < V<sub>CC</sub>.
5. Repetitive rating; pulse-width limited by maximum junction temperature.
6. L = 21 mH, starting T<sub>J</sub> = 25°C

## THERMAL IMPEDANCE (T<sub>A</sub> = 25°C unless otherwise specified)

Symbol	Parameter	Value	Unit
θ <sub>JA</sub>	Junction-to-Ambient Thermal Impedance (Note 7)	93	°C/W

7. JEDEC recommended environment, JESD51-2 and test board, JESD51-10 with minimum land pattern for 8DIP and JESD51-3 with minimum land pattern for 8LSOP.

## ELECTRICAL CHARACTERISTICS (T<sub>A</sub> = 25°C unless otherwise specified)

Symbol	Parameter	Test Condition	Min	Typ	Max	Unit
--------	-----------	----------------	-----	-----	-----	------

### SENSEFET SECTION

BV <sub>DSS</sub>	Drain-Source Breakdown Voltage	V <sub>CC</sub> = 0 V, I <sub>D</sub> = 250 μA	650	-	-	V
I <sub>DSS</sub>	Zero Gate Voltage Drain Current	V <sub>DS</sub> = 650 V, V <sub>GS</sub> = 0 V	-	-	50	μA
		V <sub>DS</sub> = 520 V, V <sub>GS</sub> = 0 V, T <sub>A</sub> = 125°C (Note 8)	-	-	250	μA
R <sub>DS(ON)</sub>	Drain-Source On-State Resistance (Note 9)	V <sub>GS</sub> = 10 V, I <sub>D</sub> = 0.3 A	-	14	19	Ω
C <sub>ISS</sub>	Input Capacitance	V <sub>GS</sub> = 0 V, V <sub>DS</sub> = 25 V, f = 1 MHz	-	162	-	pF
C <sub>OSS</sub>	Output Capacitance	V <sub>GS</sub> = 0 V, V <sub>DS</sub> = 25 V, f = 1 MHz	-	14.9	-	pF
C <sub>RSS</sub>	Reverse Transfer Capacitance	V <sub>GS</sub> = 0 V, V <sub>DS</sub> = 25 V, f = 1 MHz	-	2.7	-	pF
t <sub>r</sub>	Rise Time	V <sub>DS</sub> = 325 V, I <sub>D</sub> = 0.5 A, R <sub>G</sub> = 25 Ω	-	6.1	-	ns
t <sub>f</sub>	Fall Time	V <sub>DS</sub> = 325 V, I <sub>D</sub> = 0.5 A, R <sub>G</sub> = 25 Ω	-	43.6	-	ns

### CONTROL SECTION

f <sub>OSC</sub>	Switching Frequency	V <sub>FB</sub> = 4 V, V <sub>CC</sub> = 10 V	61	67	73	KHz
Δf <sub>OSC</sub>	Switching Frequency Variation	-25°C < T <sub>J</sub> < 85°C	-	±5	±10	%
f <sub>M</sub>	Frequency Modulation (Note 8)		-	±3	-	kHz
D <sub>MAX</sub>	Maximum Duty Cycle	V <sub>FB</sub> = 4 V, V <sub>CC</sub> = 10 V	66	72	78	%
D <sub>MIN</sub>	Minimum Duty Ratio	V <sub>FB</sub> = 0 V, V <sub>CC</sub> = 10 V	0	0	0	%

# FSL206MR

## ELECTRICAL CHARACTERISTICS (T<sub>A</sub> = 25°C unless otherwise specified) (continued)

Symbol	Parameter	Test Condition	Min	Typ	Max	Unit
V <sub>START</sub>	UVLO Threshold Voltage	V <sub>FB</sub> = 0 V, V <sub>CC</sub> Sweep	7	8	9	V
V <sub>STOP</sub>		After Turn-on	6	7	8	V
I <sub>FB</sub>	Feedback Source Current	V <sub>FB</sub> = 0, V <sub>CC</sub> = 10 V	90	110	130	μA
t <sub>S/S</sub>	Internal Soft-Start Time	V <sub>FB</sub> = 4 V, V <sub>CC</sub> = 10 V	10	15	20	ms

### BURST-MODE SECTION

V <sub>BURH</sub>	Burst-Mode HIGH Threshold Voltage	V <sub>CC</sub> = 10 V V <sub>FB</sub> Increase	FSL206MR	0.66	0.83	1.00	V
			FSL206MRB	0.40	0.50	0.60	V
V <sub>BURL</sub>	Burst-Mode LOW Threshold Voltage	V <sub>CC</sub> = 10 V V <sub>FB</sub> Decrease	FSL206MR	0.59	0.74	0.89	V
			FSL206MRB	0.28	0.35	0.42	V
HYS <sub>BUR</sub>	Burst-Mode Hysteresis		FSL206MR	-	90	-	mV
			FSL206MRB	-	150	-	mV

### PROTECTION SECTION

I <sub>LIM</sub>	Peak Current Limit	V <sub>FB</sub> = 4 V, di/dt = 300 mA/μs, V <sub>CC</sub> = 10 V	0.54	0.60	0.66	A
t <sub>CLD</sub>	Current Limit Delay Time (Note 8)		-	100	-	ns
V <sub>SD</sub>	Shutdown Feedback Voltage	V <sub>CC</sub> = 10 V	4.5	5.0	5.5	V
I <sub>DELAY</sub>	Shutdown Delay Current	V <sub>FB</sub> = 4 V	2.1	2.7	3.3	μA
t <sub>LEB</sub>	Leading Edge Blanking Time (Note 8)		250	-	-	ns
V <sub>AOCP</sub>	Abnormal Over-Current Protection (Note 8)		-	0.7	-	V
V <sub>OVP</sub>	Over-Voltage Protection	V <sub>FB</sub> = 4 V, V <sub>CC</sub> Increase	23.0	24.5	26.0	V
V <sub>LS_OFF</sub>	Line-Sense Protection On to Off	V <sub>FB</sub> = 3 V, V <sub>CC</sub> = 10 V, V <sub>LS</sub> Decrease	1.9	2.0	2.1	V
V <sub>LS_ON</sub>	Line-Sense Protection Off to On	V <sub>FB</sub> = 3 V, V <sub>CC</sub> = 10 V, V <sub>LS</sub> Increase	1.4	1.5	1.6	V
TSD	Thermal Shutdown Temperature (Note 8)		125	135	150	°C
HYS <sub>TSD</sub>	TSD Hysteresis Temperature (Note 8)		-	60	-	°C

### HIGH VOLTAGE REGULATOR SECTION

H <sub>HVR</sub>	HV Regulator Voltage	V <sub>FB</sub> = 0 V, V <sub>STR</sub> = 40 V	-	7.8	-	V
------------------	----------------------	--	---	-----	---	---

### TOTAL DEVICE SECTION

I <sub>OP1</sub>	Operating Supply Current (Control Part Only, without Switching)	V <sub>CC</sub> = 15 V, 0 V < V <sub>FB</sub> < V <sub>BURL</sub>	-	0.3	0.5	mA
I <sub>OP2</sub>	Operating Supply Current (Control Part Only, without Switching)	V <sub>CC</sub> = 8 V, 0 V < V <sub>FB</sub> < V <sub>BURL</sub>	-	0.25	0.45	mA
I <sub>OP3</sub>	Operating Supply Current (Note 8) (While Switching)	V <sub>CC</sub> = 15 V, V <sub>BURL</sub> < V <sub>FB</sub> < V <sub>SD</sub>	-	-	1.3	mA
I <sub>CH</sub>	Startup Charging Current	V <sub>CC</sub> = 0 V, V <sub>STR</sub> > 40 V	1.6	1.9	2.4	mA
I <sub>START</sub>	Startup Current	V <sub>CC</sub> = Before V <sub>START</sub> , V <sub>FB</sub> = 0 V	-	100	150	μA
V <sub>STR</sub>	Minimum V <sub>STR</sub> Supply Voltage	V <sub>CC</sub> = V <sub>FB</sub> = 0 V, V <sub>STR</sub> Increase	-	26	-	V

Product parametric performance is indicated in the Electrical Characteristics for the listed test conditions, unless otherwise noted. Product performance may not be indicated by the Electrical Characteristics if operated under different conditions.

8. Though guaranteed by design, it is not 100% tested in production.

9. Pulse test: pulse width = 300 ms, duty cycle = 2%.

TYPICAL PERFORMANCE CHARACTERISTICS

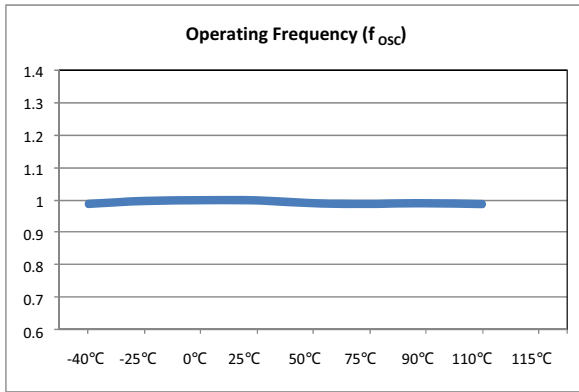

Figure 4. Operating Frequency vs. Temperature

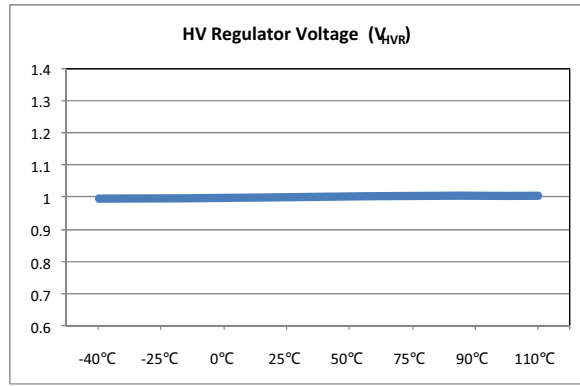

Figure 5. HV Regulator Voltage vs. Temperature

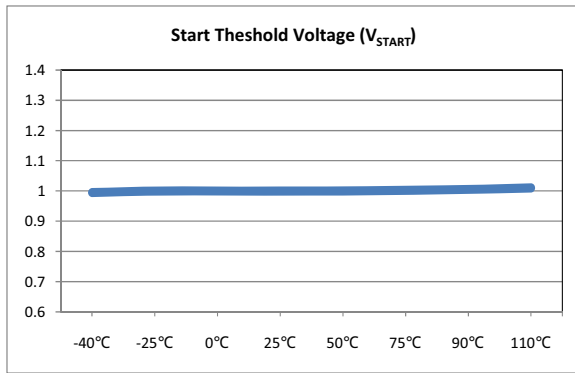

Figure 6. Start Threshold Voltage vs. Temperature

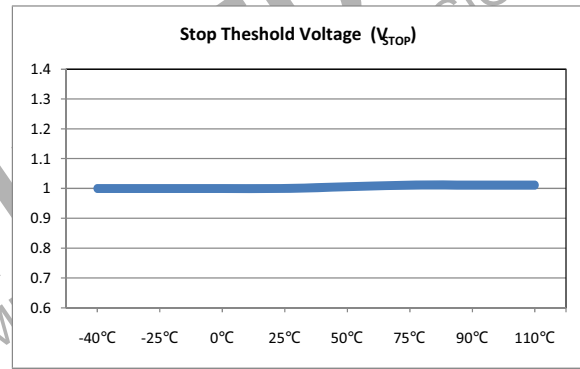

Figure 7. Stop Threshold Voltage vs. Temperature

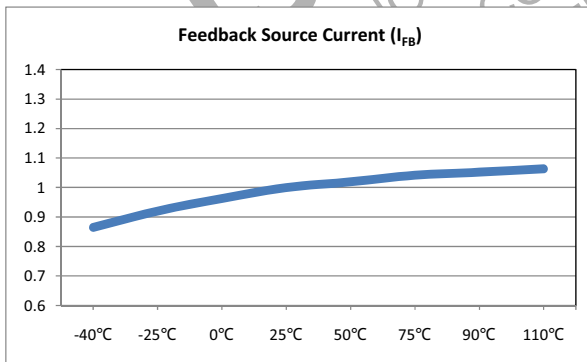

Figure 8. Feedback Source Current vs. Temperature

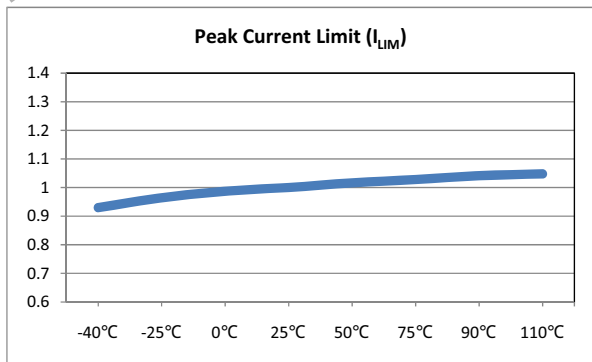

Figure 9. Peak Current Limit vs. Temperature

# FSL206MR

## TYPICAL PERFORMANCE CHARACTERISTICS (Continued)

(These Characteristic graphs are normalized at  $T_A = 25^\circ\text{C}$ .)

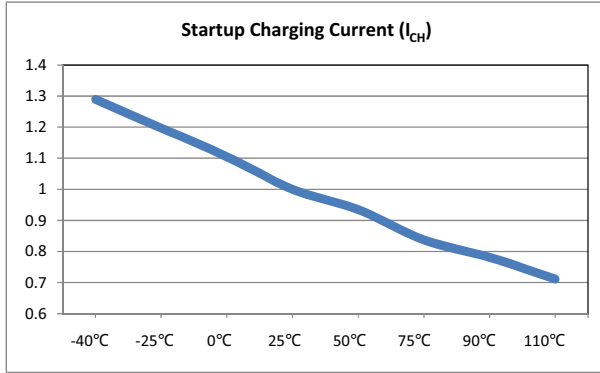

Figure 10. Startup Charging Current vs. Temperature

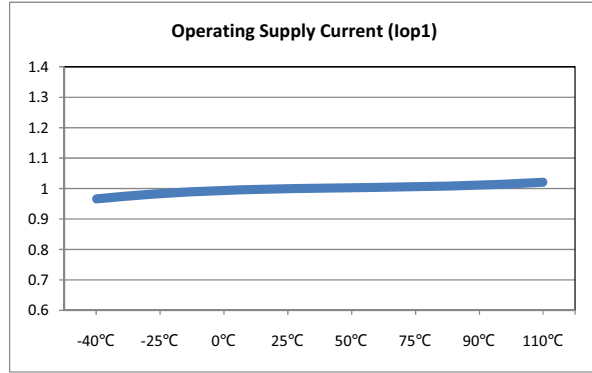

Figure 11. Operating Supply Current 1 vs. Temperature

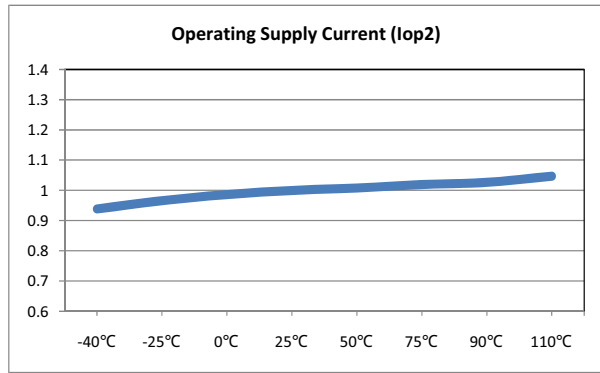

Figure 12. Operating Supply Current 2 vs. Temperature

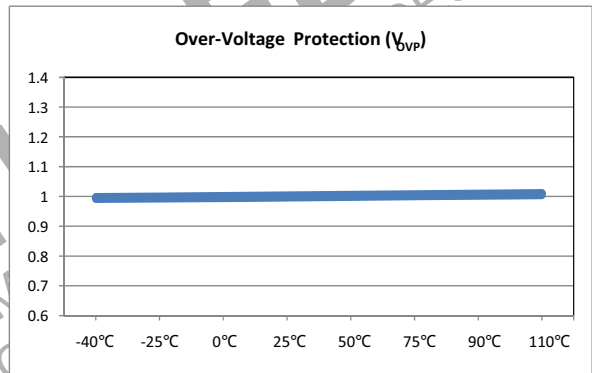

Figure 13. Over-Voltage Protection Voltage vs. Temperature

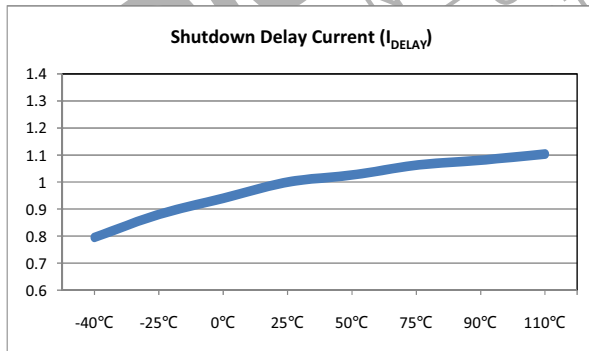

Figure 14. Shutdown Delay Current vs. Temperature



**FUNCTIONAL DESCRIPTION**

**Startup**

At startup, an internal high-voltage current source supplies the internal bias and charges the external capacitor ( $C_A$ ) connected with the  $V_{CC}$  pin, as illustrated in Figure 15. An internal high-voltage regulator (HV REG) located between the  $V_{STR}$  and  $V_{CC}$  pins regulates the  $V_{CC}$  to 7.8 V and supplies operating current. Therefore, FSL206MR needs no auxiliary bias winding.

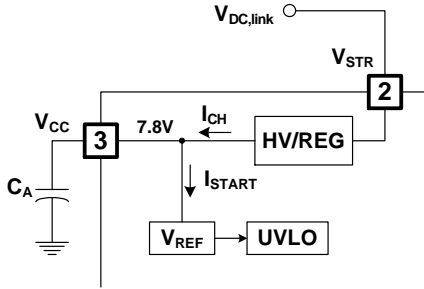

**Figure 15. Startup Block**

**Oscillator Block**

The oscillator frequency is set internally and the power switch has a random frequency fluctuation function. Fluctuation of the switching frequency of a switched power supply can reduce EMI by spreading the energy over a wider frequency range than the bandwidth measured by the EMI test equipment. The amount of EMI reduction is directly related to the range of the frequency variation. The range of frequency variation is fixed internally; however, its selection is randomly chosen by the combination of external feedback voltage and internal free-running oscillator. This randomly chosen switching frequency effectively spreads the EMI noise nearby switching frequency and allows the use of a cost-effective inductor instead of an AC input line filter to satisfy the world-wide EMI requirements.

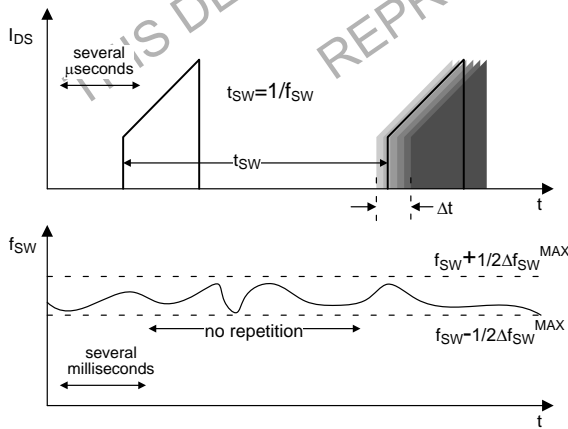

**Figure 16. Frequency Fluctuation Waveform**

**Feedback Control**

FSL206MR employs current-mode control, as shown in Figure 17. An opto-coupler (such as the FOD817A) and shunt regulator (such as the KA431) are typically used to implement the feedback network. Comparing the feedback voltage with the voltage across the  $R_{SENSE}$  resistor makes it possible to control the switching duty cycle. When the shunt regulator reference pin voltage exceeds the internal reference voltage of 2.5 V, the optocoupler LED current increases, the feedback voltage  $V_{FB}$  is pulled down, and the duty cycle is reduced. This typically occurs when the input voltage is increased or the output load is decreased.

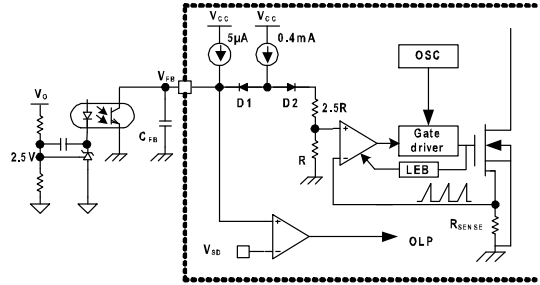

**Figure 17. Pulse-Width-Modulation (PWM) Circuit**

**Leading-Edge Blanking (LEB)**

At the instant the internal SENSEFET is turned on, the primary-side capacitance and secondary-side rectifier diode reverse recovery typically cause a high-current spike through the SENSEFET. Excessive voltage across the  $R_{SENSE}$  resistor leads to incorrect feedback operation in the current-mode PWM control. To counter this effect, the power switch employs a leading-edge blanking (LEB) circuit (see the Figure 17). This circuit inhibits the PWM comparator for a short time ( $t_{LEB}$ ) after the SENSEFET is turned on.

**Protection Circuits**

The protective functions include Overload Protection (OLP), Over-Voltage Protection (OVP), Under-Voltage Lockout (UVLO), Line Under-Voltage Protection (LUV), Abnormal Over-Current Protection (AOCP), and thermal shutdown power switch. Because these protection circuits are fully integrated inside the IC without external components, reliability is improved without increasing cost. Once a fault condition occurs, switching is terminated and the SENSEFET remains off. This causes  $V_{CC}$  to fall. When  $V_{CC}$  reaches the UVLO stop voltage  $V_{STOP}$  (7 V), the protection is reset and the internal high-voltage current source charges the  $V_{CC}$  capacitor via the  $V_{STR}$  pin. When  $V_{CC}$  reaches the UVLO start voltage  $V_{START}$  (8 V), the FPS resumes normal operation. In this manner, auto-restart can alternately enable and disable the switching of the power SENSEFET until the fault condition is eliminated.



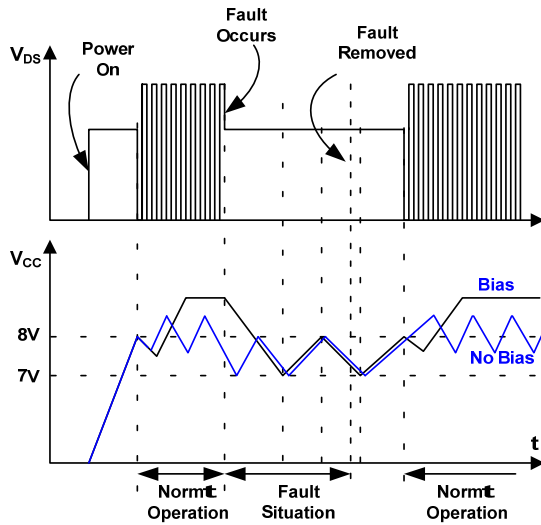

Figure 18. Auto-Restart Protection Waveforms

**Overload Protection (OLP)**

Overload is defined as the load current exceeding a preset level due to an unexpected event. In this situation, the protection circuit should be activated to protect the SMPS. However, even when the SMPS is operating normally, the overload protection (OLP) circuit can be activated during the load transition or startup. To avoid this undesired operation, the OLP circuit is activated after a specified time to determine whether it is a transient situation or a true overload situation. The Current-Mode feedback path limits the current in the SENSEFET when the maximum PWM duty cycle is attained. If the output consumes more than this maximum power, the output voltage ( $V_O$ ) decreases below its rating voltage. This reduces the current through the opto-coupler LED, which also reduces the opto-coupler transistor current, increasing the feedback voltage ( $V_{FB}$ ). If  $V_{FB}$  exceeds 2.4 V, the feedback input diode is blocked and the 2.7  $\mu$ A current source ( $I_{DELAY}$ ) starts to charge  $C_{FB}$  slowly up. In this condition,  $V_{FB}$  increases until it reaches 5 V, when the switching operation is terminated, as shown in Figure 19. The shutdown delay is the time required to charge  $C_{FB}$  from 2.4 V to 5 V with 2.7  $\mu$ A current source.

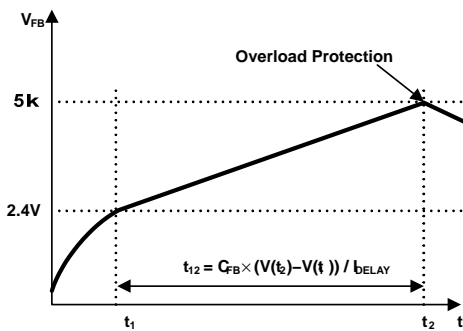

Figure 19. Overload Protection (OLP)

**Abnormal Over-Current Protection (AOCP)**

When the secondary rectifier diodes or the transformer pin are shorted, a steep current with extremely high di/dt can flow through the SENSEFET during the LEB time. Even though the power switch has OLP (Overload Protection), it is not enough to protect the FPS in that abnormal case, since severe current stress is imposed on the SENSEFET until OLP triggers. The power switch includes the internal AOCP (Abnormal Over-Current Protection) circuit shown in Figure 20. When the gate turn-on signal is applied to the power SENSEFET, the AOCP block is enabled and monitors the current through the sensing resistor. The voltage across the resistor is compared with a preset AOCP level. If the sensing resistor voltage is greater than the AOCP level, the set signal is applied to the latch, resulting in the shutdown of the SMPS.

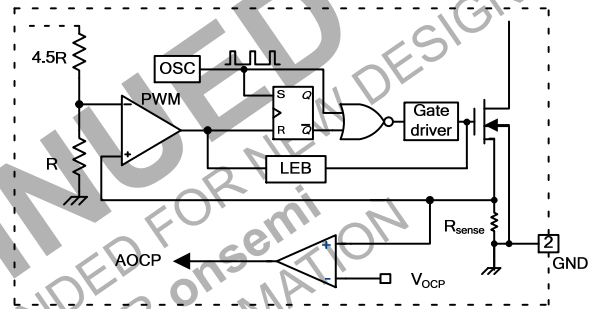

Figure 20. Abnormal Over-Current Protection

**Thermal Shutdown (TSD)**

The SENSEFET and control IC being integrated makes it easier to detect the temperature of the SENSEFET. When the junction temperature exceeds  $\sim 135^\circ\text{C}$ , thermal shutdown is activated and the power switch is restarted after temperature decreases to  $60^\circ\text{C}$ .

**Over-Voltage Protection (OVP)**

In the event of a malfunction in the secondary-side feedback circuit or an open feedback loop caused by a soldering defect, the current through the opto-coupler transistor becomes almost zero (refer to Figure 17). Then  $V_{FB}$  climbs up in a similar manner to the overload situation, forcing the preset maximum current to be supplied to the SMPS until the overload protection is activated. Because excess energy is provided to the output, the output voltage may exceed the rated voltage before the overload protection is activated, resulting in the breakdown of the devices in the secondary side. To prevent this situation, an over-voltage protection (OVP) circuit is employed. In general,  $V_{CC}$  is proportional to the output voltage and the FPS uses  $V_{CC}$  instead of directly monitoring the output voltage. If  $V_{CC}$  exceeds 24.5 V, OVP circuit is activated, resulting in termination of the switching operation. To avoid undesired activation of OVP during normal operation,  $V_{CC}$  should be designed to be below 24.5 V.

**Line Under-Voltage Protection (LUVP)**

If the input voltage of the converter is lower than the minimum operating voltage, the converter input current increases too much, causing components failure. If the input voltage is low, the converter should be protected. In the FSL206MR, the LUVP circuit senses the input voltage using the LS pin and, if this voltage is lower than 1.5 V, the LUVP signal is generated. The comparator has 0.5 V hysteresis. If the LUVP signal is generated, the output drive block is shut down and the output voltage feedback loop is saturated.

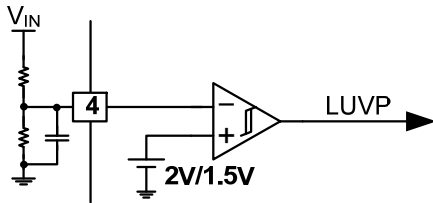

Figure 21. Line UVP Circuit

**Soft-Start**

The FSL206MR has an internal soft-start circuit that slowly increases the feedback voltage, together with the SENSEFET current, after it starts. The typical soft-start time is 15 ms, as shown in Figure 22, where progressive increments of the SENSEFET current are allowed during the startup phase. The pulse width to the power switching device is progressively increased to establish the correct working conditions for transformers, inductors, and capacitors. The voltage on the output capacitors is progressively increased with the intention of smoothly establishing the required output voltage. It also helps prevent transformer saturation and reduce the stress on the secondary diode.

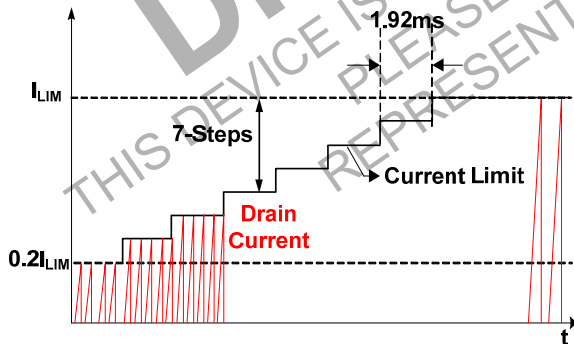

Figure 22. Internal Soft-Start

**Burst Operation**

To minimize power dissipation in Standby Mode, the power switch enters Burst Mode. As the load decreases, the feedback voltage decreases. As shown in Figure 23, the device automatically enters Burst Mode when the feedback voltage drops below  $V_{BURH}$ . Switching continues until the feedback voltage drops below  $V_{BURL}$ . At this point, switching stops and the output voltages start to drop at a rate dependent on the standby current load. This causes the feedback voltage to rise. Once it passes  $V_{BURH}$ , switching resumes. The feedback voltage then falls and the process repeats. Burst Mode alternately enables and disables switching of the SENSEFET and reduces switching loss in Standby Mode.

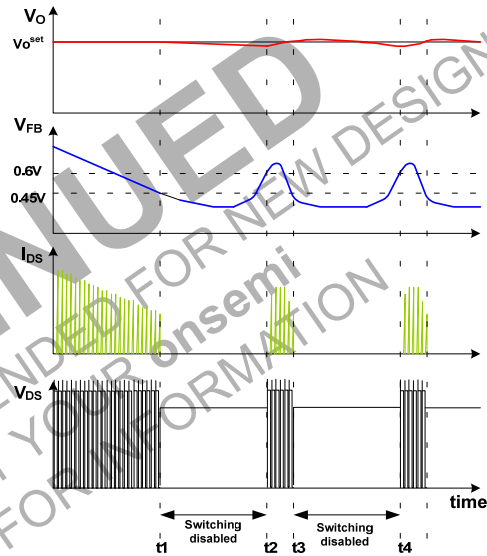

Figure 23. Burst-Mode Operation

SENSEFET is a registered trademark of Semiconductor Components Industries, LLC (SCILLC) or its subsidiaries in the United States and/or other countries.

**MECHANICAL CASE OUTLINE**  
**PACKAGE DIMENSIONS**

PDIP8 9.42x6.38, 2.54P  
CASE 646CM  
ISSUE O

DATE 31 JUL 2016

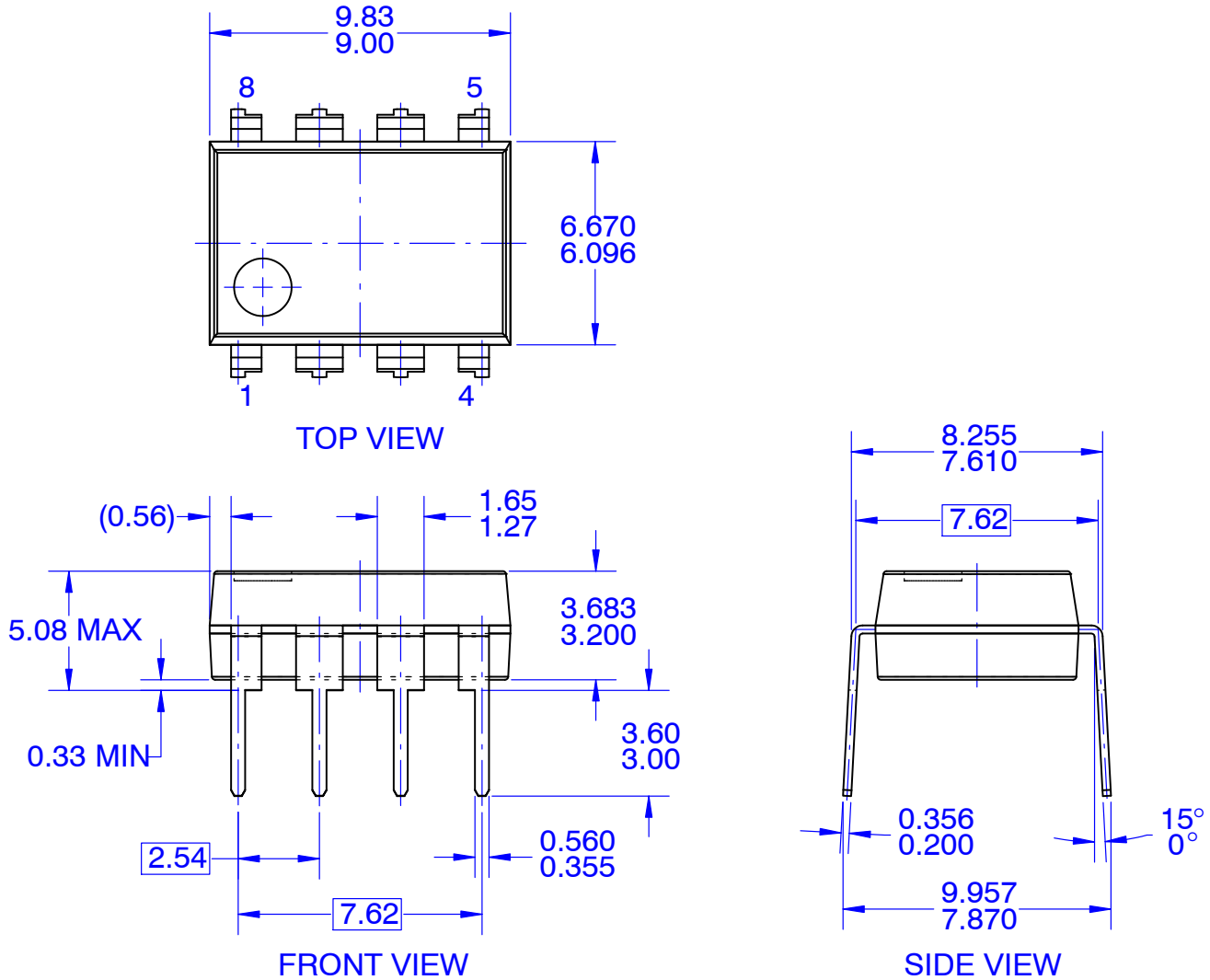

**NOTES:**

- A. CONFORMS TO JEDEC MS-001, VARIATION BA
- B. ALL DIMENSIONS ARE IN MILLIMETERS
- C. DIMENSIONS ARE EXCLUSIVE OF BURRS, MOLD FLASH, AND TIE BAR EXTRUSIONS
- D. DIMENSIONS AND TOLERANCES PER ASME Y14.5M-2009

<b>DOCUMENT NUMBER:</b>	<b>98AON13468G</b>	Electronic versions are uncontrolled except when accessed directly from the Document Repository. Printed versions are uncontrolled except when stamped "CONTROLLED COPY" in red.
<b>DESCRIPTION:</b>	<b>PDIP8 9.42X6.38, 2.54P</b>	<b>PAGE 1 OF 1</b>

ON Semiconductor and  are trademarks of Semiconductor Components Industries, LLC dba ON Semiconductor or its subsidiaries in the United States and/or other countries. ON Semiconductor reserves the right to make changes without further notice to any products herein. ON Semiconductor makes no warranty, representation or guarantee regarding the suitability of its products for any particular purpose, nor does ON Semiconductor assume any liability arising out of the application or use of any product or circuit, and specifically disclaims any and all liability, including without limitation special, consequential or incidental damages. ON Semiconductor does not convey any license under its patent rights nor the rights of others.

**MECHANICAL CASE OUTLINE**  
**PACKAGE DIMENSIONS**

ON Semiconductor®



**PDIP8 9.59x6.6, 2.54P**  
CASE 646CN  
ISSUE O

DATE 31 JUL 2016

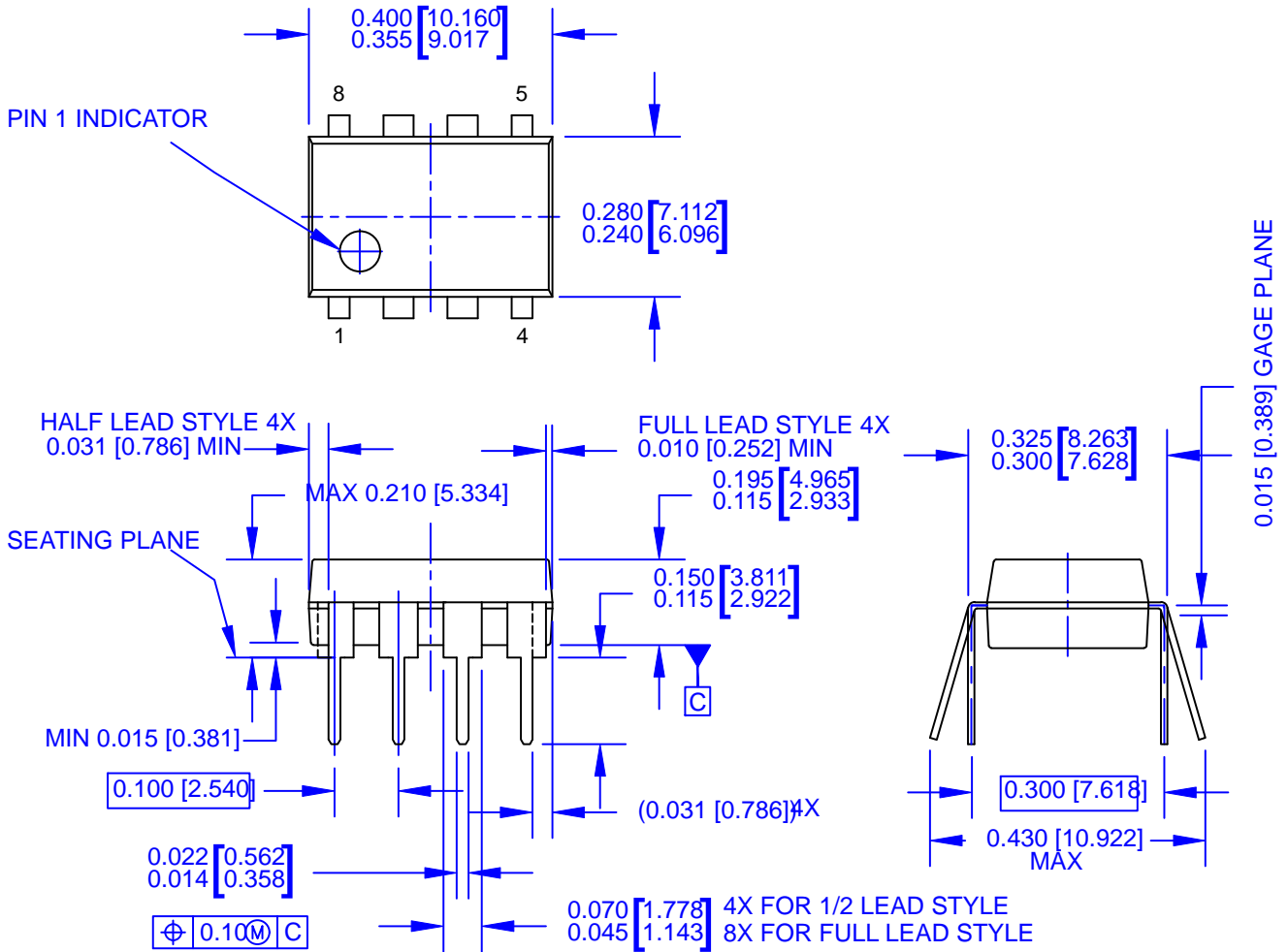

**NOTES:**

- A) THIS PACKAGE CONFORMS TO JEDEC MS-001 VARIATION BA WHICH DEFINES 2 VERSIONS OF THE PACKAGE TERMINAL STYLE WHICH ARE SHOWN HERE.
- B) CONTROLLING DIMS ARE IN INCHES
- C) DIMENSIONS ARE EXCLUSIVE OF BURRS, MOLD FLASH, AND TIE BAR EXTRUSIONS.
- D) DIMENSIONS AND TOLERANCES PER ASME Y14.5M-2009

<b>DOCUMENT NUMBER:</b>	<b>98AON13470G</b>	Electronic versions are uncontrolled except when accessed directly from the Document Repository. Printed versions are uncontrolled except when stamped "CONTROLLED COPY" in red.
<b>STATUS:</b>	<b>ON SEMICONDUCTOR STANDARD</b>	
<b>NEW STANDARD:</b>		
<b>DESCRIPTION:</b>	<b>PDIP8 9.59X6.6, 2.54P</b>	<b>PAGE 1 OF 2</b>



ISSUE	REVISION	DATE
O	RELEASED FOR PRODUCTION FROM FAIRCHILD N08M TO ON SEMICONDUCTOR. REQ. BY I. CAMBALIZA.	31 JUL 2016

ON Semiconductor and are registered trademarks of Semiconductor Components Industries, LLC (SCILLC). SCILLC reserves the right to make changes without further notice to any products herein. SCILLC makes no warranty, representation or guarantee regarding the suitability of its products for any particular purpose, nor does SCILLC assume any liability arising out of the application or use of any product or circuit, and specifically disclaims any and all liability, including without limitation special, consequential or incidental damages. "Typical" parameters which may be provided in SCILLC data sheets and/or specifications can and do vary in different applications and actual performance may vary over time. All operating parameters, including "Typicals" must be validated for each customer application by customer's technical experts. SCILLC does not convey any license under its patent rights nor the rights of others. SCILLC products are not designed, intended, or authorized for use as components in systems intended for surgical implant into the body, or other applications intended to support or sustain life, or for any other application in which the failure of the SCILLC product could create a situation where personal injury or death may occur. Should Buyer purchase or use SCILLC products for any such unintended or unauthorized application, Buyer shall indemnify and hold SCILLC and its officers, employees, subsidiaries, affiliates, and distributors harmless against all claims, costs, damages, and expenses, and reasonable attorney fees arising out of, directly or indirectly, any claim of personal injury or death associated with such unintended or unauthorized use, even if such claim alleges that SCILLC was negligent regarding the design or manufacture of the part. SCILLC is an Equal Opportunity/Affirmative Action Employer. This literature is subject to all applicable copyright laws and is not for resale in any manner.

**MECHANICAL CASE OUTLINE**  
**PACKAGE DIMENSIONS**

ON Semiconductor®



**PDIP8 GW**  
**CASE 709AJ**  
**ISSUE O**

DATE 31 JAN 2017

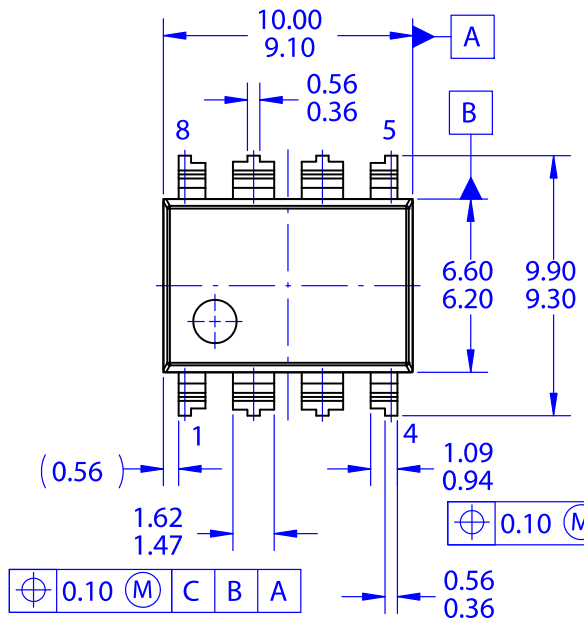

TOP VIEW

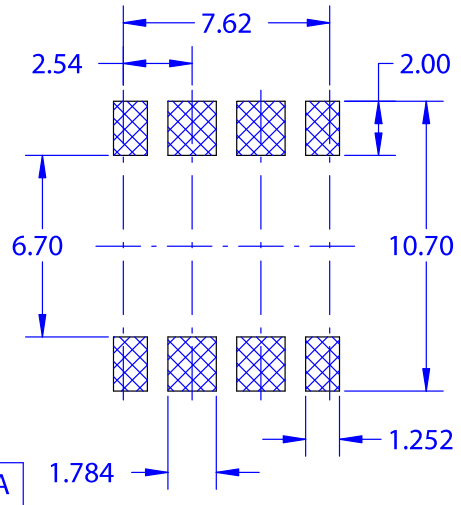

LAND PATTERN RECOMMENDATION

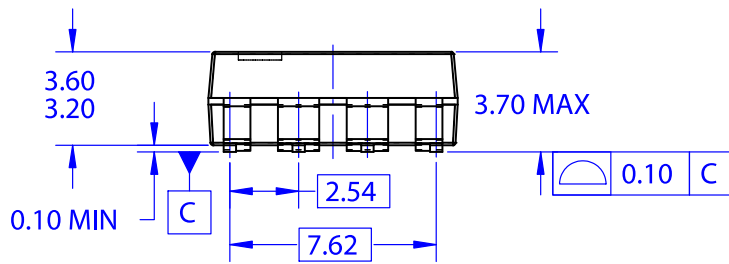

FRONT VIEW

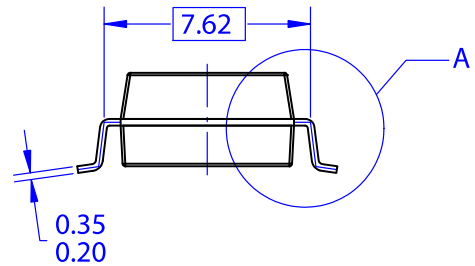

SIDE VIEW

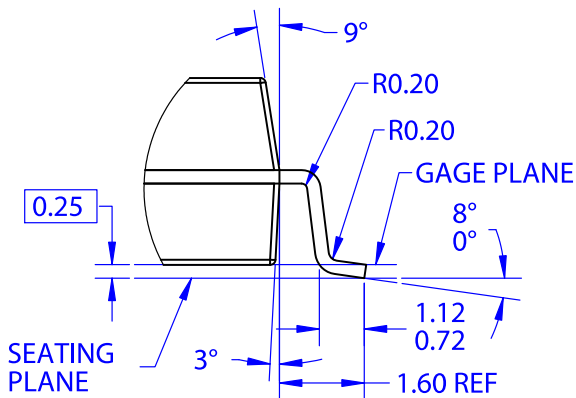

DETAIL A  
 SCALE 2:1

NOTES: UNLESS OTHERWISE SPECIFIED  
 A. NO INDUSTRY STANDARD APPLIES TO THIS PACKAGE  
 B. ALL DIMENSIONS ARE IN MILLIMETERS  
 C. DIMENSIONS ARE EXCLUSIVE OF BURRS, MOLD FLASH, AND TIE BAR EXTRUSIONS  
 D. DIMENSIONS AND TOLERANCES PER ASME Y14.5M-2009

<b>DOCUMENT NUMBER:</b>	<b>98AON13756G</b>	Electronic versions are uncontrolled except when accessed directly from the Document Repository. Printed versions are uncontrolled except when stamped "CONTROLLED COPY" in red.
<b>STATUS:</b>	<b>ON SEMICONDUCTOR STANDARD</b>	
<b>NEW STANDARD:</b>		
<b>DESCRIPTION:</b>	<b>PDIP8 GW</b>	<b>PAGE 1 OF 2</b>



ISSUE	REVISION	DATE
O	RELEASED FOR PRODUCTION FROM FAIRCHILD MKT-MLSOP08A TO ON SEMICONDUCTOR. REQ. BY D. TRUHITTE.	31 JAN 2017

ON Semiconductor and  are registered trademarks of Semiconductor Components Industries, LLC (SCILLC). SCILLC reserves the right to make changes without further notice to any products herein. SCILLC makes no warranty, representation or guarantee regarding the suitability of its products for any particular purpose, nor does SCILLC assume any liability arising out of the application or use of any product or circuit, and specifically disclaims any and all liability, including without limitation special, consequential or incidental damages. "Typical" parameters which may be provided in SCILLC data sheets and/or specifications can and do vary in different applications and actual performance may vary over time. All operating parameters, including "Typicals" must be validated for each customer application by customer's technical experts. SCILLC does not convey any license under its patent rights nor the rights of others. SCILLC products are not designed, intended, or authorized for use as components in systems intended for surgical implant into the body, or other applications intended to support or sustain life, or for any other application in which the failure of the SCILLC product could create a situation where personal injury or death may occur. Should Buyer purchase or use SCILLC products for any such unintended or unauthorized application, Buyer shall indemnify and hold SCILLC and its officers, employees, subsidiaries, affiliates, and distributors harmless against all claims, costs, damages, and expenses, and reasonable attorney fees arising out of, directly or indirectly, any claim of personal injury or death associated with such unintended or unauthorized use, even if such claim alleges that SCILLC was negligent regarding the design or manufacture of the part. SCILLC is an Equal Opportunity/Affirmative Action Employer. This literature is subject to all applicable copyright laws and is not for resale in any manner.



**onsemi**, **Onsemi**, and other names, marks, and brands are registered and/or common law trademarks of Semiconductor Components Industries, LLC dba "**onsemi**" or its affiliates and/or subsidiaries in the United States and/or other countries. **onsemi** owns the rights to a number of patents, trademarks, copyrights, trade secrets, and other intellectual property. A listing of **onsemi**'s product/patent coverage may be accessed at [www.onsemi.com/site/pdf/Patent-Marking.pdf](http://www.onsemi.com/site/pdf/Patent-Marking.pdf). **onsemi** reserves the right to make changes at any time to any products or information herein, without notice. The information herein is provided "as-is" and **onsemi** makes no warranty, representation or guarantee regarding the accuracy of the information, product features, availability, functionality, or suitability of its products for any particular purpose, nor does **onsemi** assume any liability arising out of the application or use of any product or circuit, and specifically disclaims any and all liability, including without limitation special, consequential or incidental damages. Buyer is responsible for its products and applications using **onsemi** products, including compliance with all laws, regulations and safety requirements or standards, regardless of any support or applications information provided by **onsemi**. "Typical" parameters which may be provided in **onsemi** data sheets and/or specifications can and do vary in different applications and actual performance may vary over time. All operating parameters, including "Typicals" must be validated for each customer application by customer's technical experts. **onsemi** does not convey any license under any of its intellectual property rights nor the rights of others. **onsemi** products are not designed, intended, or authorized for use as a critical component in life support systems or any FDA Class 3 medical devices or medical devices with a same or similar classification in a foreign jurisdiction or any devices intended for implantation in the human body. Should Buyer purchase or use **onsemi** products for any such unintended or unauthorized application, Buyer shall indemnify and hold **onsemi** and its officers, employees, subsidiaries, affiliates, and distributors harmless against all claims, costs, damages, and expenses, and reasonable attorney fees arising out of, directly or indirectly, any claim of personal injury or death associated with such unintended or unauthorized use, even if such claim alleges that **onsemi** was negligent regarding the design or manufacture of the part. **onsemi** is an Equal Opportunity/Affirmative Action Employer. This literature is subject to all applicable copyright laws and is not for resale in any manner.

## ADDITIONAL INFORMATION

### TECHNICAL PUBLICATIONS:

Technical Library: [www.onsemi.com/design/resources/technical-documentation](http://www.onsemi.com/design/resources/technical-documentation)  
onsemi Website: [www.onsemi.com](http://www.onsemi.com)

### ONLINE SUPPORT: [www.onsemi.com/support](http://www.onsemi.com/support)

For additional information, please contact your local Sales Representative at [www.onsemi.com/support/sales](http://www.onsemi.com/support/sales)