



5A Adjustable Low-Dropout Linear Regulator

Features

- Available in Adjust Version
- Space Saving TO-252 Package and TO-263 Package
- Internal Short Circuit Current Limiting
- Internal Over Temperature Protection
- Output Current 5A

Applications

- Post Regulation for Switching DC/DC Converter
- High Efficiency Linear Regulator
- Battery Charger
- Battery Powered Instrumentation
- Motherboard

General Description

The G1084 is a low dropout linear regulator with a dropout of 1.2V at 5A of load current. It is available in an adjustable version, which can set the output from 1.25V to 5V with only two external resistors.

The G1084 provides over temperature and over current protection circuits to prevent it from being damaged by abnormal operating conditions.

The G1084 is available in TO-252 and TO-263 packages. A minimum of 220 μ F tantalum electrolytic capacitor is required at the output to improve the transient response and stability.

Ordering Information

ORDER NUMBER	ORDER NUMBER (Pb free)	MARKING	TEMP. RANGE	PACKAGE	PIN OPTION		
					1	2	3
G1084T43U	G1084T43Uf	G1084	-40°C to +85°C	TO-252	GND/ADJ	V _{OUT}	V _{IN}
G1084T53U	G1084T53Uf	G1084	-40°C to +85°C	TO-263	GND/ADJ	V _{OUT}	V _{IN}

* For other package types and pin options, please contact us at sales @gmt.com.tw

Order Number Identification

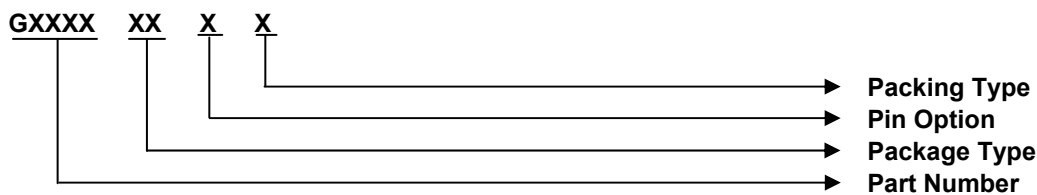

PACKAGE TYPE

T4: TO-252
T5: TO-263

PIN OPTION

1 2 3
3: GND/ADJ V_{OUT} V_{IN}

PACKING

U: Tape & Reel

Package Type

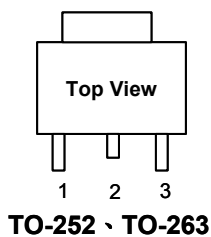

Typical Application

[Note 4]: Type of C_{OUT}

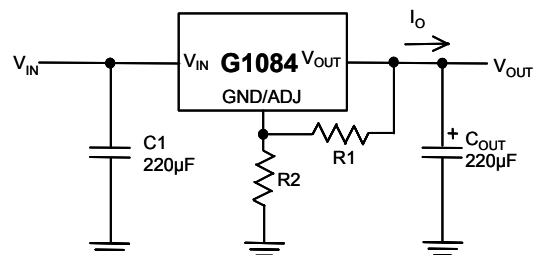

**Absolute Maximum Ratings** (Note 1)

Input Voltage.....	7V
Power Dissipation Internally Limited (Note 2)	
Maximum Junction Temperature.....	150°C
Storage Temperature Range.....	-65°C ≤ T _J ≤ +150°C
Reflow Temperature (soldering, 10sec).....	260°C
Thermal Resistance Junction to Ambient TO-252 ⁽¹⁾	125°C/W
TO-263 ⁽¹⁾	100°C/W
Thermal Resistance Junction to Case TO-252.....	10°C/W
TO-263.....	6°C/W
ESD Rating (Human Body Model).....	2kV

Operating Conditions (Note 1)

(V _{IN} -V _{ADJ}) Voltage.....	2.5V~5.5V
Temperature Range.....	-40°C ≤ T _A ≤ 85°C

Note ⁽¹⁾: See Recommended Minimum Footprint

Electrical Characteristics

Operating Conditions: V_{IN} ≤ 5.5V, T_A = T_J = 25°C unless otherwise specified. [Note3]

PARAMETER	CONDITION	MIN	TYP	MAX	UNIT
Reference Voltage	V _{IN} - V _{OUT} = 2V, I _{OUT} = 10mA	1.225	1.250	1.275	V
Line Regulation	(V _{OUT} + 1.5V) ≤ V _{IN} ≤ 5.5V, I _{OUT} = 10mA	---	0.5	1	%
Load Regulation	(V _{IN} - V _{OUT}) = 2V, 10mA ≤ I _{OUT} ≤ 5A	---	0.04	0.5	%
Dropout Voltage	ΔV _{OUT} = 2%, I _{OUT} = 5A	---	1.3	1.5	V
Current Limit	(V _{IN} - V _{OUT}) = 2V	---	5.4	---	A
Adjust Pin Current Change	V _{IN} - V _{OUT} = 2V, 10mA ≤ I _{OUT} ≤ 5A	---	0.15	---	μA
Minimum Load Current	1.5V ≤ (V _{IN} - V _{OUT}) ≤ 5.25V	10	---	---	mA
Quiescent Current	V _{IN} - V _{OUT} = 2V	---	80	150	μA
Ripple Rejection	f = 120Hz, C _{OUT} = 10μF Tantalum, (V _{IN} - V _{OUT}) = 3V, I _{OUT} = 1A	---	45	---	dB
Temperature Stability	V _{IN} = 4V, I _O = 10mA	---	0.3	---	%
RMS Output Noise (% of V _{OUT})	T _A = 25°C, 10Hz ≤ f ≤ 10kHz, I _{LOAD} = 10mA	---	0.007	---	%
Thermal Shutdown	Junction Temperature	---	150	---	°C
Thermal Shutdown Hysteresis		---	30	---	°C

Note 1: Absolute Maximum Ratings are limits beyond which damage to the device may occur. Operating Conditions are conditions under which the device functions but the specifications might not be guaranteed. For guaranteed specifications and test conditions see the Electrical Characteristics.

Note2: The maximum power dissipation is a function of the maximum junction temperature, T_{Jmax}; total thermal resistance, θ_{JA}, and ambient temperature T_A. The maximum allowable power dissipation at any ambient temperature is T_{Jmax}-T_A / θ_{JA}. If this dissipation is exceeded, the die temperature will rise above 150°C and IC will go into thermal shutdown.

Note3: Low duty pulse techniques are used during test to maintain junction temperature as close to ambient as possible.

Note4: The type of output capacitor should be tantalum or aluminum.

**Definitions****Output Voltage**

The G1084 provides an adjustable output voltage from 1.25V to 5V. with two external resistors. It can be formulated as:

$$V_{OUT} = 1.25V \times \left(1 + \frac{R_2}{R_1}\right) + I_{ADJ} \times R_2$$

$$I_{ADJ} = 80\mu A \text{ (typ.)}$$

Dropout Voltage

The input/output Voltage differential at which the regulator output no longer maintains regulation against further reductions in input voltage. Measured when the output drops 2% below its nominal value. Dropout voltage is affected by junction temperature, load current and minimum input supply requirements.

Line Regulation

The change in output voltage for a change in input voltage. The measurement is made under conditions of low dissipation or by using pulse techniques such that average chip temperature is not significantly affected.

Load Regulation

The change in output voltage for a change in load current at constant chip temperature. The measurement is made under conditions of low dissipation or by using pulse techniques such that average chip temperature is not significantly affected.

Maximum Power Dissipation

The maximum total device dissipation for which the regulator will operate within specifications.

Quiescent Bias Current

Current which is used to operate the regulator chip and is not delivered to the load.



Typical Performance Characteristics

($V_{IN}-V_{OUT} = 3V$, $V_{OUT} = 1.25V$, $C_{IN} = 220\mu F$, $C_{OUT} = 220\mu F$, $T_A=25^\circ C$, unless otherwise noted.)

Line Transient Response

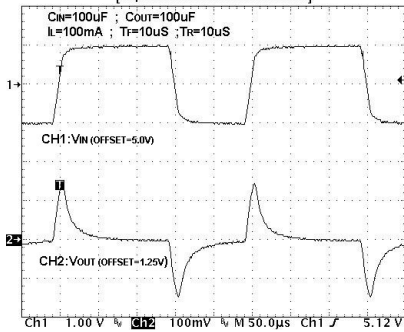

Load Transient Response

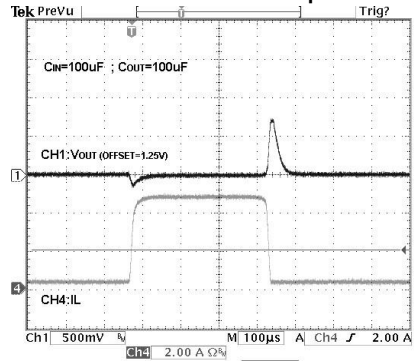

Short Circuit-Current

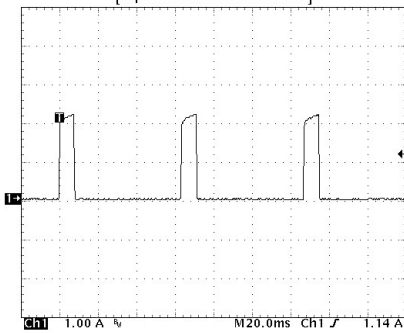

Output Noise

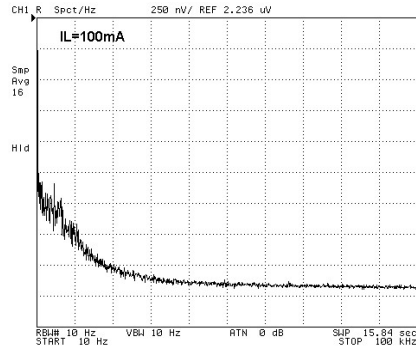

Ripple Rejection

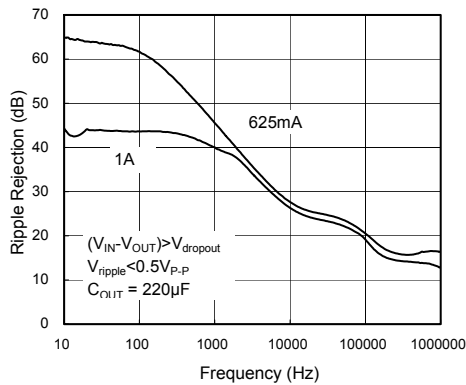

Line Regulation

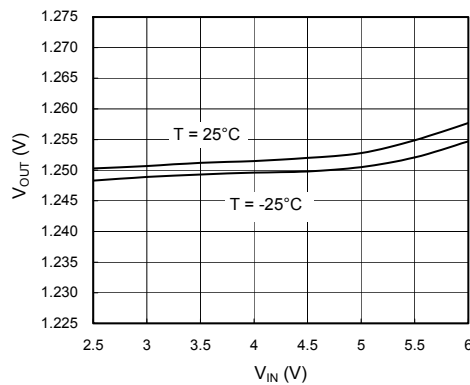



Typical Performance Characteristics (continued)

Dropout Voltage vs. I_{OUT}

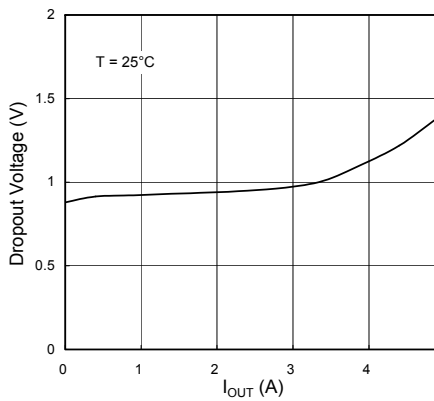

Load Regulation

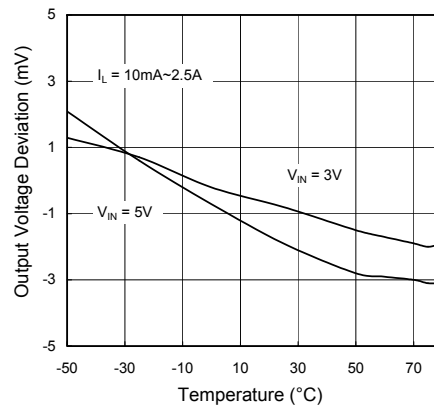

Output Voltage vs. Temperature

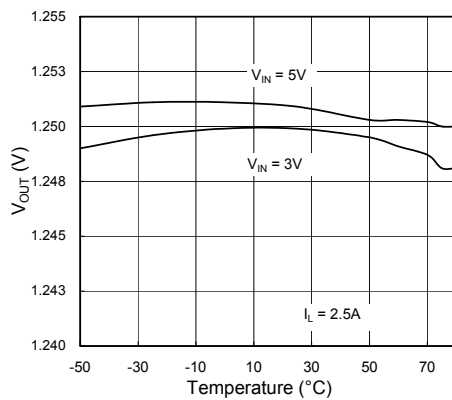

Adj Pin Current vs. Temperature

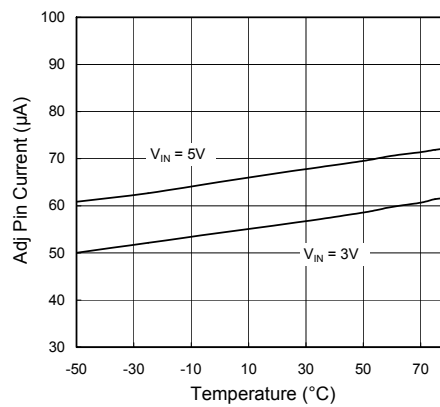

G1084T43(TO-252) Max. Power Dissipation vs. PCB Top Copper Area T_{AMB} = 25°C ; Still Air

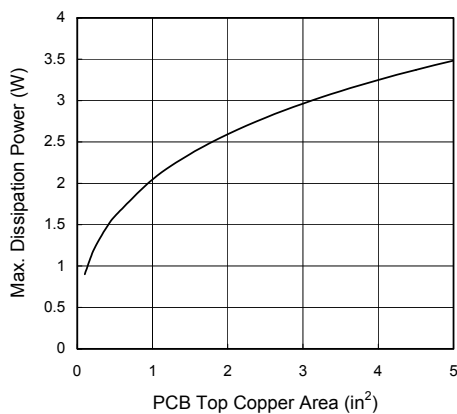

G1084T43(TO-252) Max. Power Dissipation vs. T_{AMB} (still air) (Different PCB Top Copper Area)

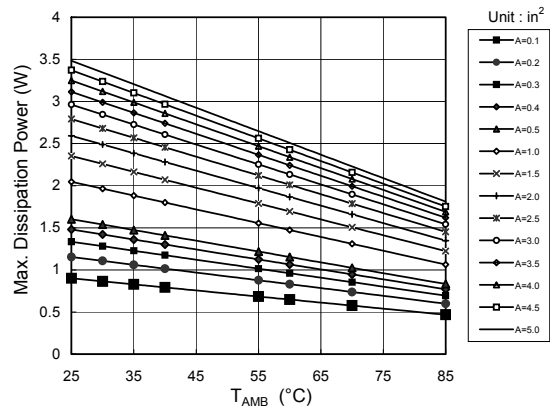

Typical Performance Characteristics (continued)

G1084T53(TO-263) Max. Power Dissipation vs. PCB Top Copper Area
 Area $T_{AMB} = 25^{\circ}C$; Still Air

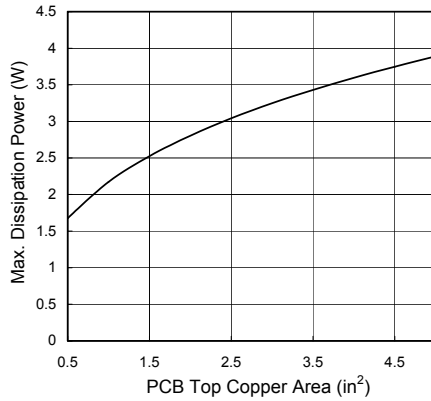

G1084T53(TO-263) Max. Power Dissipation vs. T_{AMB} (still air)
 (Different PCB Top Copper Area)

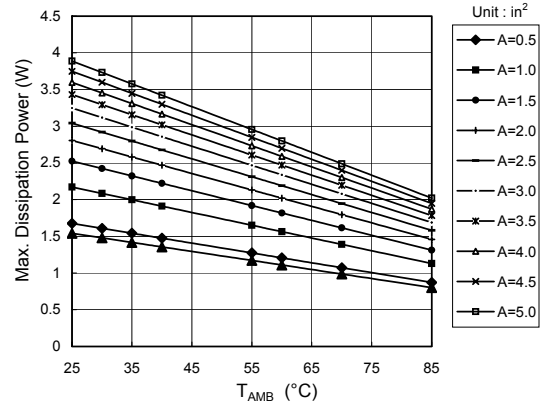

Recommend Minimum Footprint





Package Information

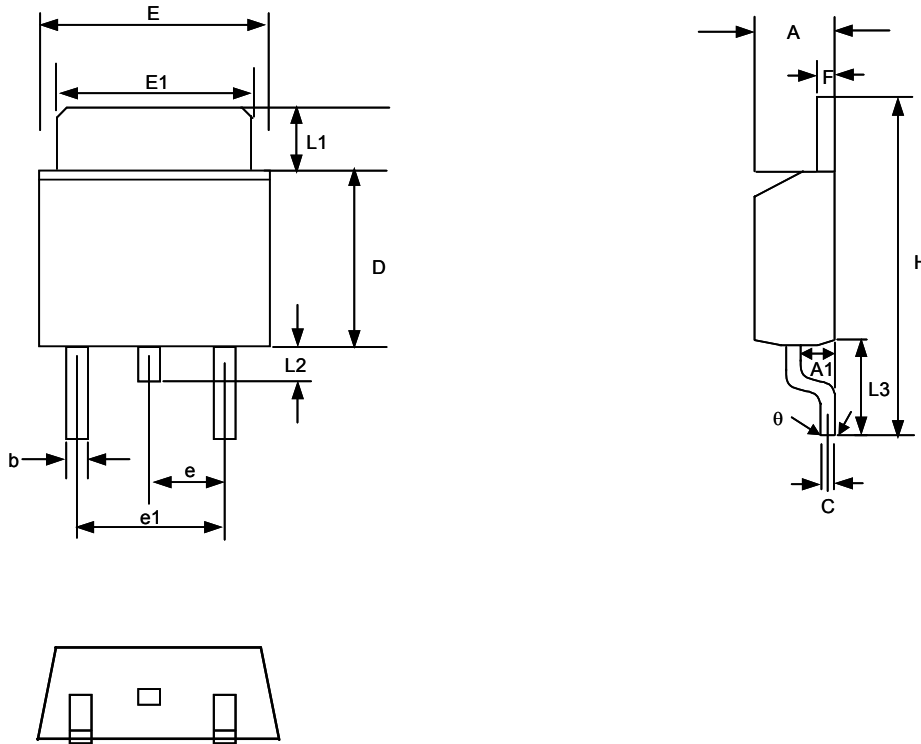

TO-252 (T4) Package

SYMBOL	MILLIMETER		INCH	
	MIN.	MAX.	MIN.	MAX.
A	2.19	2.38	0.086	0.094
A1	0.89	1.27	0.035	0.050
b	0.64	0.89	0.025	0.035
C	0.46	0.58	0.018	0.023
D	5.97	6.22	0.235	0.245
E	6.35	6.73	0.250	0.265
E1	5.21	5.46	0.205	0.215
e	2.26BSC		0.09BSC	
e1	3.96	5.18	0.156	0.204
F	0.46	0.58	0.018	0.023
L1	0.89	2.03	0.035	0.080
L2	0.64	1.02	0.025	0.040
L3	2.40	2.80	0.095	0.110
H	9.40	10.40	0.370	0.410
θ	0°	4°	0°	4°

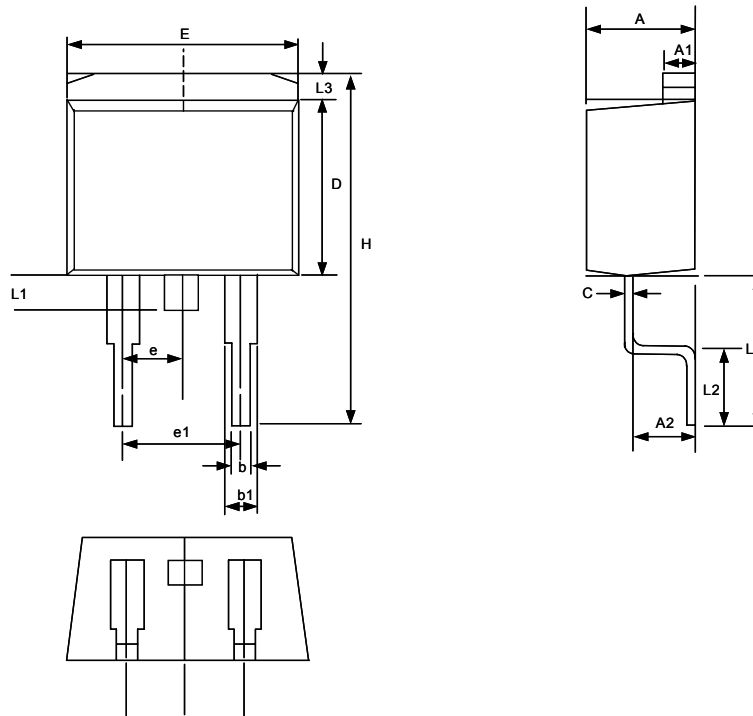

TO-263 (T5) Package

SYMBOL	MILLIMETER		INCH	
	MIN	MAX	MIN	MAX
A	4.30	4.70	0.169	0.185
A1	1.22	1.32	0.048	0.055
A2	2.45	2.69	0.104	0.106
b	0.69	0.94	0.027	0.037
b1	1.22	1.40	0.048	0.055
C	0.36	0.56	0.014	0.022
D	8.64	9.652	0.340	0.380
E	9.70	10.54	0.382	0.415
e	2.29	2.79	0.090	0.110
e1	4.83	5.33	0.190	0.210
H	14.60	15.78	0.575	0.625
L	4.70	5.84	0.185	0.230
L1	1.20	1.778	0.047	0.070
L2	2.24	2.84	0.088	0.111
L3	1.40MAX		0.055MAX	

Taping Specification

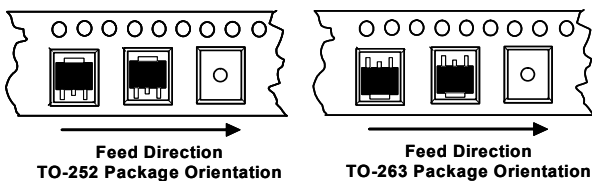

PACKAGE	Q'TY/REEL
TO-252	2,500 ea
TO-263	1,000 ea

GMT Inc. does not assume any responsibility for use of any circuitry described, no circuit patent licenses are implied and GMT Inc. reserves the right at any time without notice to change said circuitry and specifications.