

<b>Contents</b>	<b><a href="#">7</a></b>
<b>Selector Guide</b>	
<b>Alphanumeric Index of Types</b>	
<hr/>	
<b>General Technical Information</b>	<b><a href="#">27</a></b>
<hr/>	
<b>IF Filters for Intercarrier Applications</b>	<b><a href="#">47</a></b>
<hr/>	
<b>IF Filters for Quasi/Split Sound Applications</b>	<b><a href="#">115</a></b>
<hr/>	
<b>IF Filters for Video Applications</b>	<b><a href="#">181</a></b>
<hr/>	
<b>IF Filters for Audio Applications</b>	<b><a href="#">217</a></b>
<hr/>	
<b>Satellite Filters</b>	<b><a href="#">247</a></b>
<hr/>	
<b>Vestigial Sideband Filters</b>	<b><a href="#">273</a></b>
<hr/>	
<b>Spectrum-Shaping Filters</b>	<b><a href="#">293</a></b>
<hr/>	
<b>Bandpass Filters</b>	<b><a href="#">303</a></b>
<hr/>	
<b>Clock Recovery Filters</b>	<b><a href="#">325</a></b>
<hr/>	
<b>Resonators</b>	<b><a href="#">333</a></b>
<hr/>	
<b>Low-Loss Filters for Mobile Communication</b>	<b>on request</b>
<hr/>	
<b>Symbols and Terms</b>	<b><a href="#">347</a></b>
<b>Subject Index</b>	<b><a href="#">350</a></b>

# SIEMENS

SCS on the Internet

## Creating new links

As of now you can tie up with Passive Components and Electron Tubes Group plus Siemens Matsushita Components on the Internet. On our home page under

**<http://www.siemens.de/pr/index.htm>**

you'll find the latest short form catalogs, data books, technical articles and more subjects too. You can view the documents on-line, or download them to your PC. The "Installation" menu item tells you how to do it. Thanks to the integrated search function, you only have to enter key terms to go straight to the right document. And of course, you can get in touch with us direct by E mail at any time.

**SCS – dependable, fast and competent**

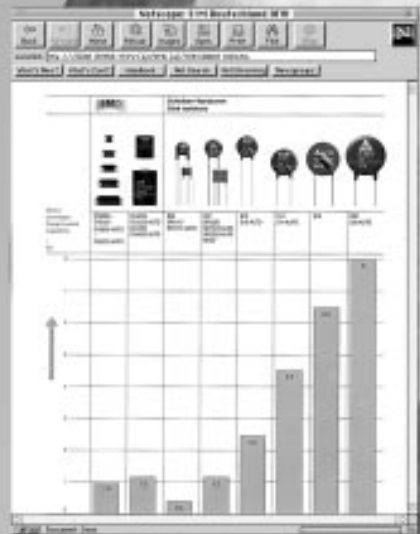

# SAW Components



Siemens Matsushita Components

Siemens filters from stock

## Ready, steady, go

SCS has 100,000 SIFI filters in stock, ready to go as soon as your order arrives. We offer a big selection through all the many variants, ie



building-block system, different attenuation characteristics and packages, various kinds of leads and current ratings from 1 through 20 A.

**SCS – dependable, fast and competent**



## Preface

---

Surface acoustic wave (SAW) components from Siemens Matsushita Components rank among the key devices of modern information and communication technology. Fabricated in submicron technologies they are high-tech devices that feature not only outstanding precision, but also small size, high reproducibility and excellent long-term stability.

SAW components are used as bandpass filters, as frequency-stabilizing devices and for complex signal processing functions. The following summary gives you a survey of our product line and points out the benefits of the individual filter groups.

- **Intercarrier, quasi/split sound, video and audio filters**

Sophisticated design and production processes create extremely high precision in the passband and excellent adjacent-channel selectivity. As a consequence no cost-intensive matching elements and extra traps are necessary. Switchable SAW filters for multistandard applications enable switching of the transfer function for different TV standards. These filters come in miniaturized plastic packages (SIP 5 K and DIP 10 K) ready for automatic processing.

- **Satellite filters**

Satellite filters are applied in analog and digital satellite receivers for channel filtering on the IF level. Dual-channel filters allow the reception of signals from two satellites with different transponder bandwidths. Yet another benefit is switchover when reception deteriorates in poor weather like rain and snow. The smaller bandwidth means better signal/noise ratio and higher selectivity – and thus much improved picture and sound reproduction.

- **Bandpass, vestigial sideband and spectrum-shaping filters**

Telecommunications makes high demands: precise bandpass characteristics, flat passbands, steep skirts and high selectivity. SAW filters offer the tailored solution. They are used as bandpass filters in digital satellite and cable receivers, as vestigial sideband filters in TV transmitters, cable headends and transposers, and for spectrum shaping in digital radio relay systems.

- **Clock recovery filters**

In digital telecommunications, on coaxial copper or fiber-optic cable, the signal has to be regenerated at regular intervals to avoid bit errors. For this S+M Components offers standard SAW filters for the frequency range 50 through 2500 MHz, assuring reliable clock recovery even at high transmission rates.

- **Resonators**

SAW resonators are key components in remote control and telemetry systems. They are used in heating energy controllers, garage door openers and keyless entry systems for cars, to name just a few examples. SAW resonators work in the fundamental mode, from 200 through 900 MHz, allowing small and highly stable oscillator circuits. They come in hermetically sealed TO 39 or SMD packages, as one-port and two-port resonators, covering all common frequencies.

- **Low-loss filters for mobile communication**

For designers of cellular and cordless phones, low weight and low space requirements are the outstanding advantages of SAW filters. Our RF and IF filters come in miniaturized SMD packages down to a size of only  $3,8 \times 3,8$  mm. The ultra-small DCC 6 package has a weight of no more than 0,07 g. Furthermore the filters can do without external matching elements and promote compact, low-power circuit design. Steep passband skirts of the filter improve speech quality; low insertion loss means less power consumed and thus longer battery life, or smaller and therefore lighter batteries.

## Preface

---

This data book presents the current product range of Siemens Matsushita Components, with exemplary specification of typical standard types in full detail. Filters which are only listed in the surveys without further specification are marked by the sign #. Detailed information on these types can be obtained from your nearest Siemens Sales Office.

Although the data book is intended to give comprehensive information about our product range, its focus is necessarily on standard products. Our special strength are custom filter solutions. With a special design software, devised in-house, and advanced CAD methods SAW filters can be rapidly designed and modified to customer specifications.

If you have any questions, if you need information on special applications not covered in this data book, or applications engineering support, do not hesitate to contact your nearest Siemens Sales Office, Passive Components and Electron Tubes Group; an address list is contained in the last chapter.

	Page
<b>Selector guide</b>	<a href="#"><u>9</u></a>
<b>Alphanumeric index of types</b>	<a href="#"><u>22</u></a>
<b>General technical information</b>	<a href="#"><u>27</u></a>
1 Introduction	<a href="#"><u>27</u></a>
1.1 Construction	<a href="#"><u>27</u></a>
2 Operating principles of TV IF filters	<a href="#"><u>27</u></a>
2.1 Fundamentals	<a href="#"><u>27</u></a>
2.2 Phase velocity of surface acoustic waves	<a href="#"><u>28</u></a>
2.3 Chip size	<a href="#"><u>28</u></a>
2.4 Filter design	<a href="#"><u>28</u></a>
3 Characteristics	<a href="#"><u>29</u></a>
3.1 Feedthrough signals	<a href="#"><u>29</u></a>
3.2 Triple-transit echo (TTE)	<a href="#"><u>29</u></a>
3.3 Reflections (spurious signals)	<a href="#"><u>29</u></a>
3.4 Pulse response	<a href="#"><u>29</u></a>
3.5 Frequency response	<a href="#"><u>30</u></a>
3.6 Group delay of TV IF filters	<a href="#"><u>30</u></a>
3.7 Filter impedances	<a href="#"><u>30</u></a>
3.8 Temperature coefficient of frequency	<a href="#"><u>33</u></a>
4 Testing	<a href="#"><u>33</u></a>
4.1 Final measurements	<a href="#"><u>33</u></a>
4.2 Measurement results in the frequency range (e.g. TV IF filter for B/G standard)	<a href="#"><u>33</u></a>
4.3 Minimum, maximum and typical values	<a href="#"><u>34</u></a>
4.4 Pulse response (time-domain measurement)	<a href="#"><u>34</u></a>
4.4.1 Test set-up for TV IF filters	<a href="#"><u>35</u></a>
4.4.2 Method of computation	<a href="#"><u>35</u></a>
4.5 Test circuits	<a href="#"><u>35</u></a>
4.6 TV test signals	<a href="#"><u>37</u></a>
5 Application notes for TV IF SAW filters	<a href="#"><u>39</u></a>
5.1 Other operating conditions	<a href="#"><u>39</u></a>
5.2 Matching and driver stage	<a href="#"><u>39</u></a>
5.3 Switchable video/intercarrier SAW filters for multistandard applications	<a href="#"><u>39</u></a>
5.4 Switchable audio SAW filters for multistandard applications	<a href="#"><u>40</u></a>
6 Application notes for resonators and resonator filters	<a href="#"><u>41</u></a>
6.1 Typical oscillation circuits	<a href="#"><u>41</u></a>
6.1.1 Oscillators using a one-port resonator	<a href="#"><u>41</u></a>
6.1.2 Oscillators using a two-port resonator	<a href="#"><u>42</u></a>
6.2 Application for a wireless remote control system at 433,92 MHz	<a href="#"><u>43</u></a>
7 Date codes, packing units	<a href="#"><u>45</u></a>
7.1 Date codes	<a href="#"><u>45</u></a>
7.2 Packing units (pcs)	<a href="#"><u>45</u></a>

# Contents

---

8	Quality	<a href="#">46</a>
8.1	Delivery quality	<a href="#">46</a>
8.2	Certification	<a href="#">46</a>
8.3	Qualification	<a href="#">46</a>
8.4	Classification of defects	<a href="#">46</a>
8.5	Incoming inspection	<a href="#">46</a>
8.6	Quality data	<a href="#">46</a>
<b>IF filters for intercarrier applications</b>		<a href="#">47</a>
<b>IF filters for quasi/split sound applications</b>		<a href="#">115</a>
<b>IF filters for video applications</b>		<a href="#">181</a>
<b>IF filters for audio applications</b>		<a href="#">217</a>
<b>Satellite filters</b>		<a href="#">247</a>
<b>Vestigial sideband filters</b>		<a href="#">273</a>
<b>Spectrum-shaping filters</b>		<a href="#">293</a>
<b>Bandpass filters</b>		<a href="#">303</a>
<b>Clock recovery filters</b>		<a href="#">325</a>
<b>Resonators</b>		<a href="#">333</a>
<b>Symbols and terms</b>		<a href="#">347</a>
<b>Standards</b>		<a href="#">349</a>
<b>Subject index</b>		<a href="#">350</a>



## Selector Guide

### IF filters for intercarrier applications



Picture carrier MHz	Standard	Package	Type	Remarks	Page
33,90	L	SIP 5 K	K 2962 M	2 Nyquist slopes (L/L')	<a href="#">90</a>
36,88	B	SIP 5 K	B 1952 M		<a href="#">49</a>
38,00	D/K	SIP 5 K	D 1952 M		<a href="#">52</a>
	D/K, B/G	SIP 5 K	K 2953 M		<a href="#">55</a>
	D/K, B/G	SIP 5 K	K 2954 M		<a href="#">47</a>
	D/K, B/G	SIP 5 K	K 2958 M		<a href="#">58</a>
	M/N	DIP 10 K	K 6265 K	Internally switchable	<a href="#">61</a>
	D/K, B/G	DIP 10 K	K 6265 K	Internally switchable	<a href="#">61</a>
38,90	D/K	SIP 5 K	D 1990 M		<a href="#">47</a>
	B/G	SIP 5 K	G 1872 M		<a href="#">47</a>
	B/G	SIP 5 K	G 1875 M		<a href="#">66</a>
	B/G	SIP 5 K	G 1960 M	For CENELEC	<a href="#">47</a>
	B/G	SIP 5 K	G 1961 M	For CENELEC	<a href="#">47</a>
	B/G	SIP 5 K	G 1962 M	For CENELEC	<a href="#">69</a>
	B/G	SIP 5 K	G 1963 M	For CENELEC	<a href="#">47</a>
	B/G	SIP 5 K	G 1965 M	For CENELEC	<a href="#">72</a>
	B/G	SIP 5 K	G 1966 M	For CENELEC	<a href="#">75</a>
	B/G	SIP 5 K	G 1967 M	For CENELEC	<a href="#">47</a>
	B/G	SIP 5 K	G 1968 M	For CENELEC	<a href="#">78</a>
	B/G	SIP 5 K	G 1980 M	For CENELEC	<a href="#">47</a>
	B/G NICAM	SIP 5 K	G 1984 M	For CENELEC	<a href="#">47</a>
	I	SIP 5 K	J 1952 M	For CENELEC	<a href="#">81</a>
	I	SIP 5 K	J 1955 M		<a href="#">47</a>
	I NICAM	SIP 5 K	J 1980 M		<a href="#">84</a>
	B/G, D/K	SIP 5 K	K 2951 M		<a href="#">47</a>
	B/G, D/K	SIP 5 K	K 2955 M		<a href="#">87</a>
	B/G, D/K	SIP 5 K	K 2960 M		<a href="#">47</a>
	B/G, D/K	SIP 5 K	K 2962 M	2 Nyquist slopes (L/L')	<a href="#">90</a>
	B/G	DIP 10 K	K 6255 K	Internally switchable For CENELEC	<a href="#">93</a>
	D/K	DIP 10 K	K 6255 K	Internally switchable	<a href="#">93</a>
	B/G	DIP 10 K	K 6256 K	Internally switchable	<a href="#">98</a>
B/G	DIP 10 K	K 6259 K	Internally switchable Also for video appl.	<a href="#">47</a>	
M/N	DIP 10 K	K 6259 K	Internally switchable	<a href="#">47</a>	

## Selector Guide

Picture carrier MHz	Standard	Package	Type	Remarks	Page
IF filters for intercarrier applications (continued)					
38,90	B/G	DIP 10 K	K 6260 K	Internally switchable Also for video appl.	<a href="#">47</a>
	M/N	DIP 10 K	K 6262 K	Internally switchable Also for video appl.	<a href="#">47</a>
	M/N	SIP 5 K	M 1956 M		<a href="#">47</a>
39,50	I	SIP 5 K	J 1951 M	For CENELEC	<a href="#">103</a>
	I	SIP 5 K	J 1953 M		<a href="#">48</a>
45,75	M/N	SIP 5 K	M 1859 M	For FCC EIA	<a href="#">106</a>
	M/N	SIP 5 K	M 1861 M		<a href="#">48</a>
	M/N	SIP 5 K	M 1958 M		<a href="#">48</a>
	M/N	SIP 5 K	M 1962 M		<a href="#">109</a>
	M/N	SIP 5 K	M 1963 M		<a href="#">48</a>
	M/N	SIP 5 K	M 1966 M		<a href="#">48</a>
58,75	M	SIP 5 K	N 1951 M		<a href="#">112</a>

## IF filters for quasi/split sound applications



Picture carrier MHz	Standard	Package	Type	Remarks	Page
33,90	L	DIP 10 K	K 3261 K		<a href="#">116</a>
36,88	B	DIP 10 K	B 3250 K		<a href="#">115</a>
38,00	D/K	DIP 10 K	D 3650 K		<a href="#">115</a>
	D/K	DIP 10 K	K 3264 K		<a href="#">120</a>
38,90	B/G NICAM	DIP 10 K	G 3254 K	For CENELEC	<a href="#">115</a>
	B/G NICAM	DIP 10 K	G 3255 K		<a href="#">115</a>
	B/G NICAM	DIP 10 K	G 3258 K	For CENELEC	<a href="#">124</a>
	B/G NICAM	DIP 10 K	G 3264 K	For CENELEC	<a href="#">128</a>
	B/G NICAM	DIP 10 K	G 3270 K	For twin PLL ICs	<a href="#">115</a>
	B/G NICAM	DIP 10 K	G 3354 K	For CENELEC	<a href="#">115</a>
	B/G NICAM	DIP 10 K	G 3355 K	For CENELEC	<a href="#">132</a>
	B/G NICAM	DIP 10 K	G 3356 K	For CENELEC	<a href="#">115</a>
	B/G NICAM	DIP 10 K	G 3357 K		<a href="#">115</a>

Picture carrier MHz	Standard	Package	Type	Remarks	Page
<b>IF filters for quasi/split sound applications (continued)</b>					
38,90	B/G NICAM	DIP 10 K	G 3652 K		<a href="#">115</a>
	I NICAM	DIP 10 K	J 3251 K		<a href="#">136</a>
	I NICAM	DIP 10 K	J 3351 K		<a href="#">140</a>
	I NICAM	DIP 10 K	J 3652 K		<a href="#">115</a>
	L	DIP 10 K	K 3252 K		<a href="#">115</a>
	B/G, D/K, I	DIP 10 K	K 3258 K		<a href="#">144</a>
	B/G	DIP 10 K	K 3261 K		<a href="#">116</a>
	B/G, D/K	DIP 10 K	K 3350 K	For CENELEC	<a href="#">148</a>
39,50	I NICAM	DIP 10 K	J 3252 K		<a href="#">152</a>
	I NICAM	DIP 10 K	J 3352 K	For CENELEC	<a href="#">156</a>
45,75	M/N	DIP 10 K	M 3251 K		<a href="#">115</a>
	M/N	DIP 10 K	M 3271 K	For twin PLL ICs	<a href="#">160</a>
	M/N	DIP 10 K	M 3352 K		<a href="#">115</a>
	M/N	DIP 10 K	M 3353 K		<a href="#">115</a>
	M/N	DIP 10 K	M 3354 K	For FCC	<a href="#">164</a>
	M/N	DIP 10 K	M 3355 K		<a href="#">115</a>
	M/N	SIP 5 K	M 3561 M		<a href="#">168</a>
	M/N	DIP 10 K	M 3654 K	For FCC	<a href="#">172</a>
58,75	M	SIP 5 K	N 3561 M		<a href="#">177</a>

### IF filters for video applications



Picture carrier MHz	Standard	Package	Type	Remarks	Page
33,40	L	SIP 5 K	G 3957 M	2 Nyquist slopes (L/L') For CENELEC	<a href="#">182</a>
	L	DIP 10 K	K 6260 K	Internally switchable Also for intercarrier appl.	<a href="#">181</a>
33,90	L	SIP 5 K	K 3953 M	2 Nyquist slopes (L/L') For CENELEC	<a href="#">185</a>
	L	DIP 10 K	K 6256 K	Internally switchable Also for intercarrier appl.	<a href="#">181</a>

## Selector Guide

Picture carrier MHz	Standard	Package	Type	Remarks	Page
IF filters for video applications (continued)					
33,90	L	DIP 10 K	K 6257 K	Internally switchable 2 Nyquist slopes (L/L') For CENELEC	<a href="#">188</a>
	L	DIP 10 K	K 6263 K	Internally switchable	<a href="#">181</a>
38,00	B/G, D/K	SIP 5 K	K 3955 M	For CENELEC	<a href="#">193</a>
	B/G, D/K	DIP 10 K	K 6266 K	Internally switchable For CENELEC	<a href="#">196</a>
	M/N	DIP 10 K	K 6266 K	Internally switchable	<a href="#">196</a>
38,90	B/G	SIP 5 K	G 3956 M	For CENELEC	<a href="#">201</a>
	B/G, L	SIP 5 K	G 3957 M	2 Nyquist slopes (L/L') For CENELEC	<a href="#">182</a>
	B/G	SIP 5 K	G 3962 M	For CENELEC	<a href="#">181</a>
	B/G	SIP 5 K	G 3963 M	For CENELEC	<a href="#">181</a>
	B/G	SIP 5 K	G 3964 M	For CENELEC	<a href="#">181</a>
	B/G	SIP 5 K	G 3965 M	For CENELEC	<a href="#">204</a>
	B/G	SIP 5 K	G 3967 M	For CENELEC	<a href="#">181</a>
	B/G, I, D/K, L	SIP 5 K	K 3953 M	For CENELEC	<a href="#">185</a>
	D/K, I, L	DIP 10 K	K 6256 K	Internally switchable Also for intercarrier appl.	<a href="#">181</a>
	B/G	DIP 10 K	K 6257 K	2 Nyquist slopes (L/L') Internally switchable For CENELEC	<a href="#">188</a>
	D/K, I, L	DIP 10 K	K 6257 K	Internally switchable	<a href="#">188</a>
	L	DIP 10 K	K 6260 K	Internally switchable Also for intercarrier appl.	<a href="#">181</a>
	B/G	DIP 10 K	K 6262 K	Internally switchable Also for intercarrier appl.	<a href="#">181</a>
	B/G, L	DIP 10 K	K 6263 K	Internally switchable	<a href="#">181</a>
	M/N	DIP 10 K	K 6263 K	Internally switchable	<a href="#">181</a>
M/N	SIP 5 K	M 3960 M		<a href="#">181</a>	
39,50	I	SIP 5 K	J 3950 M	For CENELEC	<a href="#">207</a>
45,75	M/N	SIP 5 K	M 3951 M	For FCC	<a href="#">210</a>
58,75	M	SIP 5 K	N 3954 M		<a href="#">213</a>
	M	SIP 5 K	N 3958 M		<a href="#">181</a>

IF filters for audio applications



Sound carrier MHz	Standard	Package	Type	Remarks	Page
31,50 ... 32,50	D/K, I, B/G	SIP 5 K	K 9455 M	2 channels	<a href="#">219</a>
31,50 ... 33,50	D/K, I, B/G, M/N	SIP 5 K	K 9252 M		<a href="#">217</a>
	D/K, I, B/G, M/N	SIP 5 K	K 9352 M		<a href="#">217</a>
32,40	L	SIP 5 K	L 9360 M		<a href="#">217</a>
	L	SIP 5 K	L 9362 M		<a href="#">223</a>
	L	SIP 5 K	L 9453 M	2 channels	<a href="#">217</a>
	L NICAM	SIP 5 K	L 9454 M	2 channels	<a href="#">225</a>
	L NICAM	SIP 5 K	L 9455 M	2 channels	<a href="#">217</a>
	L	SIP 5 K	L 9456 M	2 channels	<a href="#">228</a>
	L	SIP 5 K	L 9460 M	2 channels	<a href="#">217</a>
32,40 ... 32,90	D/K, L, I	SIP 5 K	K 9460 M	2 channels	<a href="#">217</a>
	D/K, L, I NICAM	SIP 5 K	K 9463 M	2 channels	<a href="#">217</a>
32,40 ... 33,40	D/K, I, B/G	SIP 5 K	K 9260 M		<a href="#">231</a>
	D/K, L, I, B/G	SIP 5 K	K 9350 M		<a href="#">217</a>
	D/K, L, I, B/G	SIP 5 K	K 9453 M	2 channels	<a href="#">233</a>
	D/K, L, I, B/G	SIP 5 K	K 9462 M	2 channels	<a href="#">217</a>
32,40 ... 34,40	D/K, I, B/G, M/N	SIP 5 K	K 9253 M		<a href="#">217</a>
32,90	I NICAM	DIP 10 K	K 4350 K	2 channels	<a href="#">217</a>
	I NICAM	SIP 5 K	K 9353 M		<a href="#">217</a>
33,40	B/G NICAM	SIP 5 K	G 9251 M		<a href="#">217</a>
	B/G, L NICAM	SIP 5 K	G 9353 M		<a href="#">237</a>
	B/G, L NICAM	DIP 10 K	K 4350 K	2 channels	<a href="#">217</a>
	B/G, L NICAM	SIP 5 K	K 9460 M	2 channels	<a href="#">217</a>
	B/G, L NICAM	SIP 5 K	K 9463 M	2 channels	<a href="#">217</a>
33,50	I NICAM	SIP 5 K	J 9250 M		<a href="#">217</a>
	M/N	SIP 5 K	K 9455 M	2 channels	<a href="#">219</a>
34,40	M/N	SIP 5 K	K 9461 M	2 channels	<a href="#">217</a>
	M/N	SIP 5 K	K 9462 M	2 channels	<a href="#">217</a>
39,20	L	SIP 5 K	L 9361 M		<a href="#">217</a>
39,90	L NICAM	SIP 5 K	L 9455 M	2 channels	<a href="#">218</a>
	L	SIP 5 K	L 9460 M	2 channels	<a href="#">218</a>
40,40	L	SIP 5 K	L 9353 M		<a href="#">218</a>

## Selector Guide

Sound carrier MHz	Standard	Package	Type	Remarks	Page
IF filters for audio applications (continued)					
40,40	L NICAM	SIP 5 K	L 9354 M		<a href="#">218</a>
	L	SIP 5 K	L 9453 M	2 channels	<a href="#">218</a>
	L NICAM	SIP 5 K	L 9454 M	2 channels	<a href="#">225</a>
	L	SIP 5 K	L 9456 M	2 channels	<a href="#">228</a>
	L	SIP 5 K	K 9453 M	2 channels	<a href="#">233</a>
	L	SIP 5 K	K 9461 M	2 channels	<a href="#">218</a>
41,00	L	SIP 5 K	L 9461 M	2 channels	<a href="#">218</a>
41,25	M/N	SIP 5 K	M 9260 M		<a href="#">240</a>
	M/N	SIP 5 K	M 9352 M		<a href="#">242</a>
54,25	M	SIP 5 K	N 9260 M		<a href="#">218</a>
	M	SIP 5 K	N 9350 M		<a href="#">245</a>

## Satellite filters



Center frequency MHz	3 dB bandwidth MHz	Package	Type	Remarks	Page
402,78	27,0 + 31,0	TO 39	B 609		<a href="#">248</a>
403,18	26,9 + 32,1	TO 39	B 629	Integr. shunt resistors	<a href="#">247</a>
	31,3	TO 39	B 682		<a href="#">253</a>
479,50	27,0 + 18,0	TO 39	B 611		<a href="#">256</a>
	27,0 + 32,0	TO 39	B 615		<a href="#">247</a>
	27,0 + 36,0	TO 39	B 619		<a href="#">247</a>
	21,5 + 27,0	TO 39	B 621		<a href="#">247</a>
	15,0 + 27,0	TO 39	B 625		<a href="#">247</a>
480,00	33,5 + 36,1	TO 39	B 635	Integr. shunt resistors	<a href="#">261</a>
	15,7	TO 39	B 662	Integr. shunt resistors	<a href="#">247</a>
	32,0	TO 39	B 674		<a href="#">247</a>
	22,5	TO 39	B 680		<a href="#">247</a>
	36,2	TO 39	B 686		<a href="#">247</a>
	26,6	TO 39	B 692	Integr. shunt resistors	<a href="#">266</a>
	17,6	TO 39	B 694	Integr. shunt resistors	<a href="#">269</a>
26,6	TO 39	B 696		<a href="#">247</a>	

## Vestigial sideband filters



Picture carrier MHz	Standard	Package	Type	Remarks	Page
32,70	L	DIP 24-06	B 540		<a href="#">273</a>
38,00	D/K	DIP 24-06	B 542	With sound suppression	<a href="#">273</a>
	D/K	SIP 6 M	B 587	With sound suppression	<a href="#">273</a>
38,90	B/G	DIP 24-03	B 522	With sound suppression	<a href="#">273</a>
	B/G	DIP 24-03	B 523		<a href="#">274</a>
	B/G	DIP 16	B 530	With sound suppression	<a href="#">277</a>
	B/G	DIP 16	B 531		<a href="#">273</a>
	B/G	DIP 24-06	B 534	With sound suppression	<a href="#">273</a>
	B/G	DIP 24-06	B 537		<a href="#">280</a>
	I	DIP 24-06	B 541		<a href="#">273</a>
	D/K	DIP 24-06	B 543		<a href="#">273</a>
	I	DIP 24-06	B 576	NICAM	<a href="#">273</a>
	B/G	SIP 6 M	B 585	With sound suppression	<a href="#">283</a>
	I	SIP 6 M	B 586	With sound suppression	<a href="#">273</a>
45,75	B/G	SIP 6 M	B 588	With sound suppression	<a href="#">273</a>
	B/G	SIP 5 K	G 4960 M	With sound suppression	<a href="#">286</a>
	D/K	SIP 5 K	K 4960 M	With sound suppression	<a href="#">273</a>
	M/N	DIP 24-06	B 545		<a href="#">289</a>
	M/N	SIP 5 K	M 4950 M	With sound suppression	<a href="#">273</a>

## Selector Guide

### Spectrum-shaping filters



Center frequency MHz	Nyquist frequency MHz	Package	Type	Page
70,00	11,95	DIP 16	B 2540	<a href="#">293</a>
	12,10	DIP 16	B 2559	<a href="#">293</a>
	12,30	DIP 16	B 2565	<a href="#">293</a>
	7,755	DIP 16	B 2569	<a href="#">294</a>
	7,755	DIP 16	B 2570	<a href="#">297</a>
	13,52	DIP 24-06	B 2573	<a href="#">293</a>
122,50	13,52	DIP 16	B 2578	<a href="#">293</a>
157,50	13,52	DIP 16	B 2579	<a href="#">300</a>
140,00	13,82	DIP 16	B 2580	<a href="#">293</a>

### Bandpass filters



Center frequency MHz	Standard	Package	Type	Page
36,00	DAB	SIP 6 M	B 589	<a href="#">303</a>
36,20	DCR	SIP 5 K	X 6967 M	<a href="#">303</a>
38,912	DAB	SIP 6 M	B 512	<a href="#">304</a>
44,00	Interactive TV	SIP 5 K	X 6959 M	<a href="#">307</a>
45,00	GSM	DIP 24-03	B 1507	<a href="#">303</a>
60,00	DSS	SIP 5 K	X 6956 M	<a href="#">310</a>



Center frequency MHz	Standard	Package	Type	Page
Bandpass filters (continued)				
70,00	—	DIP 16	B 504	<a href="#">313</a>
	—	DIP 16	B 519	<a href="#">303</a>
	—	DIP 16	B 590	<a href="#">303</a>
118,00	—	DIP 16	B 521	<a href="#">316</a>
140,00	—	DIP 16	B 1529	<a href="#">303</a>
287,35	—	DIP 16	B 1505	<a href="#">319</a>
439,85	—	TO 8	B 558	<a href="#">322</a>

## Clock recovery filters



Center frequency MHz	Insertion attenuation (max) dB	Package	Type	Page
51,840	29,5	DIP 16	B 5545	<a href="#">325</a>
139,264	21,0	TO 8	B 5505	<a href="#">325</a>
155,520	18,5	TO 8	B 5533	<a href="#">326</a>
	19,5	DIP 16	B 5549	<a href="#">325</a>
167,118	17,0	TO 8	B 5506	<a href="#">325</a>
181,043	17,5	TO 8	B 5504	<a href="#">325</a>
622,080	19,5	TO 39	B 5531	<a href="#">329</a>
	20,5	TO 8	B 5547	<a href="#">325</a>
659,157	18,0	TO 8	B 5513	<a href="#">325</a>
2488,320	21,0	TO 39	B 5534	<a href="#">325</a>







# Selector Guide

## Resonators



Center frequency MHz	Insertion attenuation dB	Package	Type	Page
-------------------------	--------------------------------	---------	------	------

### 1-port resonators

314,50	2,0	TO 39	R 660	<a href="#">333</a>
	1,5	QCC 8 	R 706	<a href="#">333</a>
315,00	2,0	TO 39	R 639	<a href="#">333</a>
	1,5	QCC 8 	R 705	<a href="#">333</a>
417,50	1,4	QCC 8 	R 704	<a href="#">333</a>
418,00	1,8	TO 39	R 643	<a href="#">333</a>
	1,4	QCC 8 	R 703	<a href="#">334</a>
423,22	1,8	TO 39	R 644	<a href="#">333</a>
433,42	1,8	TO 39	R 647	<a href="#">333</a>
	1,6	QCC 8 	R 702	<a href="#">333</a>
433,92	1,7	TO 39	R 641	<a href="#">336</a>
	1,7	QCC 8 	R 701	<a href="#">333</a>

### 2-port resonators

213,80	9,1	TO 39	R 2637	<a href="#">333</a>
224,50	8,5	TO 39	R 2523	<a href="#">333</a>
304,35	7,3	TO 39	R 2653	<a href="#">333</a>
315,05	5,5	TO 39	R 2622	<a href="#">333</a>
403,55	7,5	TO 39	R 2526	<a href="#">333</a>
407,35	8,6	TO 39	R 2635	<a href="#">333</a>
414,25	7,0	TO 39	R 2620	<a href="#">333</a>
	9,2	QCC 8 	R 2702	<a href="#">338</a>
418,05	8,3	TO 39	R 2630	<a href="#">333</a>
423,22	7,3	TO 39	R 2531	<a href="#">333</a>
433,92	7,8	TO 39	R 2632	<a href="#">340</a>
	9,2	QCC 8 	R 2701	<a href="#">333</a>
849,25	11,0	TO 39	R 2533	<a href="#">333</a>

---

Center frequency MHz	Insertion attenuation dB	Package	Type	Page
-------------------------	--------------------------------	---------	------	------

### Frontend filters for remote control

314,00	2,5	TO 39	B 3532	<a href="#">333</a>
315,00	2,5	TO 39	B 3531	<a href="#">333</a>
403,55	2,5	TO 39	B 3533	<a href="#">333</a>
433,92	2,3	TO 39	B 3530	<a href="#">343</a>



Siemens Matsushita Components

Applications with a future

## We set your ideas in motion

When it comes to implementing ideas, you couldn't choose a better partner. Our flexibility turns standard products into new designs with all the right features. Whether capacitors and converter filters for wind-driven power plants, ferrite antennas for radio wrist-watches or SAW filters for the new wide-screen TV generation. If you've got the application, we've got the component.



**SCS – dependable, fast and competent**





Siemens Matsushita Components

## Quality without compromises top with TQM

We're not satisfied until you are. So our quality demands are quite tough. And they don't start in production, they span the whole field from development to despatch. To watch over it all we implemented Total Quality Management, a system aimed at continuous improvement – in everything. That includes true-to-schedule delivery and service readiness, ISO 9000 for all plants, modern QA, commitment to the environment in manufacturing, materials and packing plus constant training of employees. All embedded in *top*, the worldwide quality campaign of the Siemens organization.



More about "top with TQM" in this brochure!

SCS – dependable, fast and competent

# top

## Components

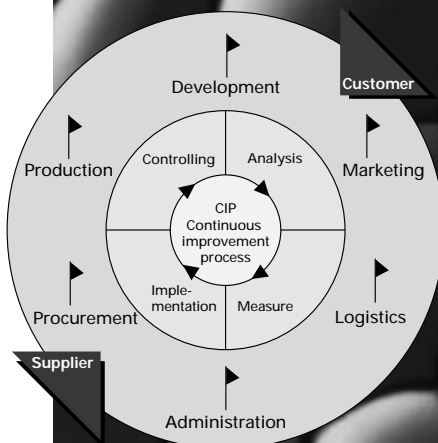

# Alphanumeric Index of Types

Type	Page
B 504	<a href="#">313</a>
B 512	<a href="#">304</a>
B 519	<a href="#">304</a>
B 521	<a href="#">316</a>
B 522	<a href="#">273</a>
B 523	<a href="#">274</a>
B 530	<a href="#">277</a>
B 531	<a href="#">273</a>
B 534	<a href="#">273</a>
B 537	<a href="#">280</a>
B 540	<a href="#">273</a>
B 541	<a href="#">273</a>
B 542	<a href="#">273</a>
B 543	<a href="#">273</a>
B 545	<a href="#">289</a>
B 558	<a href="#">322</a>
B 576	<a href="#">273</a>
B 585	<a href="#">283</a>
B 586	<a href="#">273</a>
B 587	<a href="#">273</a>
B 588	<a href="#">273</a>
B 589	<a href="#">303</a>
B 590	<a href="#">303</a>
B 609	<a href="#">248</a>
B 611	<a href="#">256</a>
B 615	<a href="#">247</a>
B 619	<a href="#">247</a>
B 621	<a href="#">247</a>
B 625	<a href="#">247</a>
B 629	<a href="#">247</a>
B 635	<a href="#">261</a>
B 662	<a href="#">247</a>
B 674	<a href="#">247</a>
B 680	<a href="#">247</a>
B 682	<a href="#">253</a>
B 686	<a href="#">247</a>
B 692	<a href="#">266</a>
B 694	<a href="#">269</a>
B 696	<a href="#">247</a>
B 1505	<a href="#">319</a>
B 1507	<a href="#">303</a>

Type	Page
B 1529	<a href="#">303</a>
B 1952 M	<a href="#">49</a>
B 2540	<a href="#">293</a>
B 2559	<a href="#">293</a>
B 2565	<a href="#">293</a>
B 2569	<a href="#">294</a>
B 2570	<a href="#">297</a>
B 2573	<a href="#">293</a>
B 2578	<a href="#">293</a>
B 2579	<a href="#">300</a>
B 2580	<a href="#">293</a>
B 3250 K	<a href="#">115</a>
B 3530	<a href="#">343</a>
B 3531	<a href="#">333</a>
B 3532	<a href="#">333</a>
B 3533	<a href="#">333</a>
B 5504	<a href="#">325</a>
B 5505	<a href="#">325</a>
B 5506	<a href="#">325</a>
B 5513	<a href="#">325</a>
B 5531	<a href="#">329</a>
B 5533	<a href="#">326</a>
B 5534	<a href="#">325</a>
B 5545	<a href="#">325</a>
B 5547	<a href="#">325</a>
B 5549	<a href="#">325</a>
D 1952 M	<a href="#">52</a>
D 1990 M	<a href="#">47</a>
D 3650 K	<a href="#">115</a>
G 1872 M	<a href="#">47</a>
G 1875 M	<a href="#">66</a>
G 1960 M	<a href="#">47</a>
G 1961 M	<a href="#">47</a>
G 1962 M	<a href="#">69</a>
G 1963 M	<a href="#">47</a>
G 1965 M	<a href="#">72</a>
G 1966 M	<a href="#">75</a>
G 1967 M	<a href="#">47</a>
G 1968 M	<a href="#">78</a>
G 1980 M	<a href="#">47</a>
G 1984 M	<a href="#">47</a>

## Alphanumeric Index of Types

Type	Page
G 3254 K	<a href="#">115</a>
G 3255 K	<a href="#">115</a>
G 3258 K	<a href="#">124</a>
G 3264 K	<a href="#">128</a>
G 3270 K	<a href="#">115</a>
G 3354 K	<a href="#">115</a>
G 3355 K	<a href="#">132</a>
G 3356 K	<a href="#">115</a>
G 3357 K	<a href="#">115</a>
G 3652 K	<a href="#">115</a>
G 3956 M	<a href="#">201</a>
G 3957 M	<a href="#">182</a>
G 3962 M	<a href="#">181</a>
G 3963 M	<a href="#">181</a>
G 3964 M	<a href="#">181</a>
G 3965 M	<a href="#">204</a>
G 3967 M	<a href="#">181</a>
G 4960 M	<a href="#">286</a>
G 9251 M	<a href="#">217</a>
G 9353 M	<a href="#">237</a>
J 1951 M	<a href="#">103</a>
J 1952 M	<a href="#">81</a>
J 1953 M	<a href="#">48</a>
J 1955 M	<a href="#">47</a>
J 1980 M	<a href="#">84</a>
J 3251 K	<a href="#">136</a>
J 3252 K	<a href="#">152</a>
J 3351 K	<a href="#">140</a>
J 3352 K	<a href="#">156</a>
J 3652 K	<a href="#">115</a>
J 3950 M	<a href="#">207</a>
J 9250 M	<a href="#">217</a>
K 2951 M	<a href="#">47</a>
K 2953 M	<a href="#">55</a>
K 2954 M	<a href="#">47</a>
K 2955 M	<a href="#">87</a>
K 2958 M	<a href="#">58</a>
K 2960 M	<a href="#">47</a>
K 2962 M	<a href="#">90</a>
K 3252 K	<a href="#">115</a>
K 3258 K	<a href="#">144</a>

Type	Page
K 3261 K	<a href="#">116</a>
K 3264 K	<a href="#">120</a>
K 3350 K	<a href="#">148</a>
K 3953 M	<a href="#">185</a>
K 3955 M	<a href="#">193</a>
K 4350 K	<a href="#">217</a>
K 4350 K	<a href="#">217</a>
K 4960 M	<a href="#">273</a>
K 6255 K	<a href="#">93</a>
K 6255 K	<a href="#">98</a>
K 6256 K	<a href="#">181</a>
K 6256 K	<a href="#">181</a>
K 6257 K	<a href="#">188</a>
K 6259 K	<a href="#">47</a>
K 6259 K	<a href="#">47</a>
K 6260 K	<a href="#">181</a>
K 6260 K	<a href="#">181</a>
K 6260 K	<a href="#">47</a>
K 6262 K	<a href="#">181</a>
K 6262 K	<a href="#">47</a>
K 6263 K	<a href="#">181</a>
K 6263 K	<a href="#">181</a>
K 6263 K	<a href="#">181</a>
K 6265 K	<a href="#">61</a>
K 6266 K	<a href="#">196</a>
K 9252 M	<a href="#">217</a>
K 9253 M	<a href="#">217</a>
K 9260 M	<a href="#">231</a>
K 9350 M	<a href="#">217</a>
K 9352 M	<a href="#">217</a>
K 9353 M	<a href="#">217</a>
K 9453 M	<a href="#">233</a>
K 9455 M	<a href="#">219</a>
K 9460 M	<a href="#">217</a>
K 9460 M	<a href="#">217</a>
K 9461 M	<a href="#">217</a>
K 9461 M	<a href="#">218</a>
K 9462 M	<a href="#">217</a>
K 9462 M	<a href="#">217</a>
K 9462 M	<a href="#">217</a>
K 9463 M	<a href="#">217</a>
K 9463 M	<a href="#">217</a>

# Alphanumeric Index of Types

Type	Page
L 9353 M	<a href="#">218</a>
L 9354 M	<a href="#">218</a>
L 9360 M	<a href="#">217</a>
L 9361 M	<a href="#">217</a>
L 9362 M	<a href="#">223</a>
L 9453 M	<a href="#">217</a>
L 9453 M	<a href="#">218</a>
L 9454 M	<a href="#">225</a>
L 9455 M	<a href="#">217</a>
L 9455 M	<a href="#">218</a>
L 9456 M	<a href="#">228</a>
L 9460 M	<a href="#">217</a>
L 9460 M	<a href="#">218</a>
L 9461 M	<a href="#">217</a>
L 9461 M	<a href="#">218</a>
M 1859 M	<a href="#">106</a>
M 1861 M	<a href="#">48</a>
M 1956 M	<a href="#">47</a>
M 1958 M	<a href="#">48</a>
M 1962 M	<a href="#">109</a>
M 1963 M	<a href="#">48</a>
M 1966 M	<a href="#">48</a>
M 3251 K	<a href="#">115</a>
M 3271 K	<a href="#">160</a>
M 3352 K	<a href="#">115</a>
M 3353 K	<a href="#">115</a>
M 3354 K	<a href="#">164</a>
M 3355 K	<a href="#">115</a>
M 3561 M	<a href="#">168</a>
M 3654 K	<a href="#">172</a>
M 3951 M	<a href="#">210</a>
M 3960 M	<a href="#">181</a>
M 4950 M	<a href="#">273</a>
M 9260 M	<a href="#">240</a>
M 9352 M	<a href="#">242</a>
N 1951 M	<a href="#">112</a>
N 3561 M	<a href="#">177</a>
N 3954 M	<a href="#">213</a>
N 3958 M	<a href="#">181</a>
N 9260 M	<a href="#">218</a>
N 9350 M	<a href="#">245</a>

Type	Page
R 639	<a href="#">333</a>
R 641	<a href="#">340</a>
R 643	<a href="#">333</a>
R 644	<a href="#">333</a>
R 647	<a href="#">333</a>
R 660	<a href="#">333</a>
R 701	<a href="#">333</a>
R 702	<a href="#">333</a>
R 703	<a href="#">334</a>
R 704	<a href="#">333</a>
R 705	<a href="#">333</a>
R 706	<a href="#">333</a>
R 2523	<a href="#">333</a>
R 2526	<a href="#">333</a>
R 2528	<a href="#">333</a>
R 2531	<a href="#">333</a>
R 2533	<a href="#">333</a>
R 2620	<a href="#">333</a>
R 2622	<a href="#">333</a>
R 2630	<a href="#">333</a>
R 2632	<a href="#">340</a>
R 2635	<a href="#">333</a>
R 2637	<a href="#">333</a>
R 2653	<a href="#">333</a>
R 2701	<a href="#">333</a>
R 2702	<a href="#">338</a>
X 6956 M	<a href="#">310</a>
X 6959 M	<a href="#">307</a>
X 6967 M	<a href="#">303</a>





Siemens Matsushita Components

A whole lot of ring core chokes

## Chokes to your choice

You urgently need particular ring core chokes? That's no problem, we have 200,000 pieces in stock and deliver reliably through SCS. Our automated production guarantees



the best of reliability too. It turns out chokes in different versions: flat and upright, with current rated from 0.4 to 16 A. UL and VDE approved, and complying with the latest EMC standards of course.

**SCS – dependable, fast and competent**

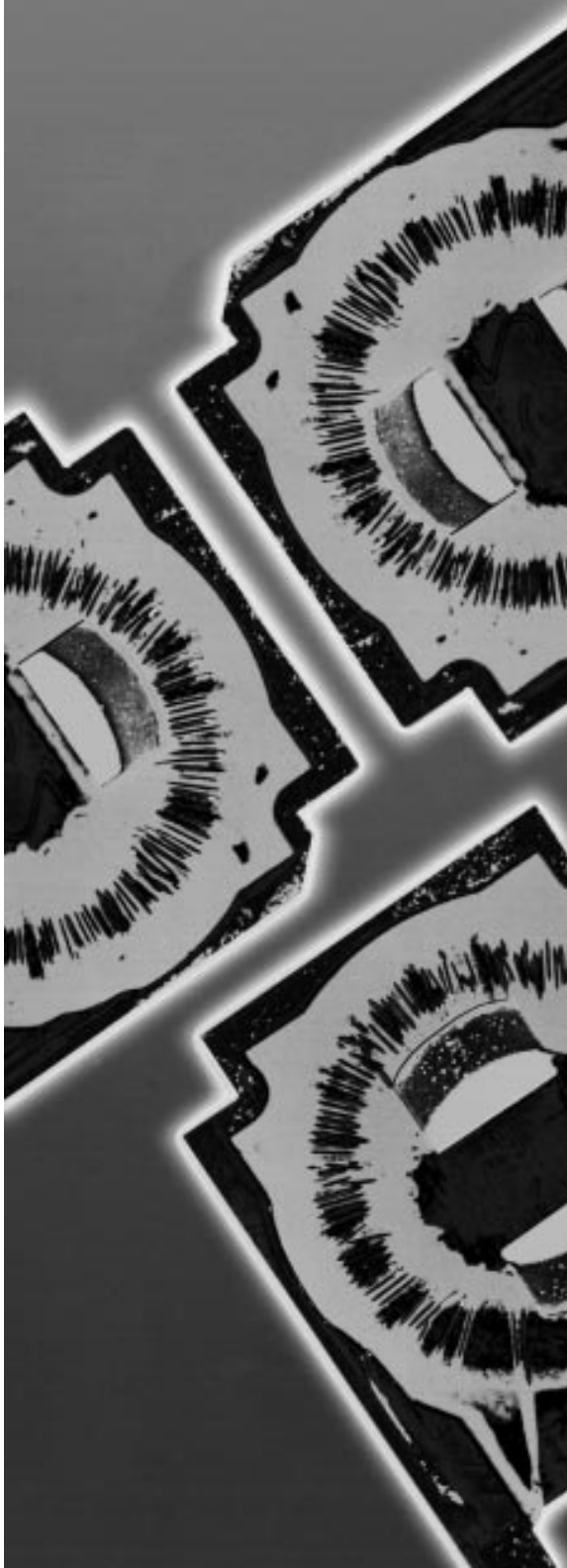



Siemens Matsushita Components

NTC thermistor chips for  
temperature compensation

## Keep cool

No matter what the temperature, that's the promise behind our NTC chips in 0805 and 1206 sizes, available direct from SCS stock. These chips do valuable service in handies, ensuring clear contrast in the display and optimum reception in the crystal oscillator, besides proper charging of the battery. In hybrid and SMT circuits, NTC chips cover a temperature range of  $-55^{\circ}\text{C}$  through  $+125^{\circ}\text{C}$ .



SCS - dependable, fast and competent

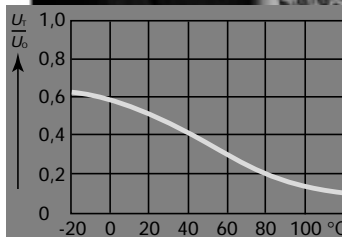

## General Technical Information

### 1 Introduction

Surface acoustic wave filters (SAW filters) are integrated, passive components with bandpass filter characteristics. Their operation is based on the interference of mechanical surface waves. Compared to coil filters, surface acoustic wave filters provide a series of favorable characteristics:

- High reproducibility
- High performance
- Stable characteristics
- No adjustment required
- Amplitude response and phase response can be specified independently of each other
- Close tolerances of data
- Small space requirements (a complete TV IF filter only takes up 0,5 cm<sup>2</sup>)

The user of a surface acoustic wave filter has a component which fully replaces complex LC combinations and yields superior picture and sound quality.

#### 1.1 Construction

A metal layer (Al) is vapor-deposited onto a single-crystal, piezoelectric substrate. Using a photo-etching technique, the metal is removed to obtain fine, finger-like interspersed electrodes (interdigital transducers), which serve as piezoelectrical input and output transducers. The substrate is then bonded to a metal base and connected to the terminals by means of bonding wires.

An absorber prevents surface waves reflected from the edges of the substrate from causing spurious signals. The SAW filter is encapsulated to protect it from external influences.

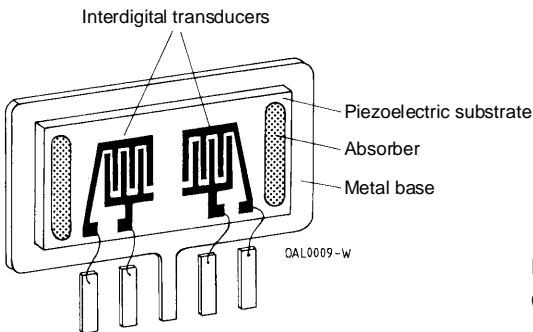

Figure 1  
Construction of a SAW TV IF filter

## 2 Operating principles of TV IF filters

### 2.1 Fundamentals

When electrical signals are applied to the input transducer, it launches mechanical (“acoustic”) surface waves which, due to reciprocity, in turn produce electrical signals in the output transducer. The transducers act as transmit/receive “antennas” for surface acoustic waves. Widely varying “antenna characteristics” can be achieved as a result of the transducer structure. The center frequency, amplitude response and group delay are determined by the number, length, arrangement and spacing of the transducer fingers (see para. 2.4). Superposing of the “antenna characteristics” of the input and output transducers results in the filter characteristic.

## General Technical Information

---

All TV IF filters included in this book consist of transducers with constant finger widths and spacings. One of the transducers has constant finger lengths (unweighted or unapodized transducer) whereas the other one has varying finger lengths (weighted or apodized transducer). In most cases the first one operates as output transducer and the second one as input transducer.

The transfer function of the unweighted transducer is  $\sin(x)/x$ -shaped; its center frequency depends on the spacing of the fingers and its bandwidth on the number of the fingers. The higher the number of the fingers, the smaller is the bandwidth of the transducer. The finger widths range from 27  $\mu\text{m}$  (G 1962 M: IF 38,9 MHz) to 1,2  $\mu\text{m}$  (B 696: IF 480,0 MHz).

The amplitude and group delay of a weighted transducer's transfer function can be set independently of each other. The transfer characteristic of the filter can be closely approximated by multiplying the transfer characteristics of the two transducers.

### 2.2 Phase velocity of surface acoustic waves

The phase velocity of surface acoustic waves is frequency-independent. Depending on the substrate material and the crystal cut, the phase velocity ranges from 3000 to 4000 m/s.

### 2.3 Chip size

The required chip size largely depends on the desired filter data. Narrowband performance, steep slopes and high group delay predistortion necessitate transducers with many fingers and, hence, with a long substrate. Filters with two inputs or outputs require broad substrates.

### 2.4 Filter design

The filter design is based on the specification of the filter and is performed in two steps.

In the first step, the linear design, the center frequency and bandwidth of the filter are used to specify the unweighted transducer as well as the width and number of fingers for the weighted transducer. The finger lengths of this transducer, which determine its transfer function, are found by a linear optimization program (simplex algorithm). In this program, a smooth pass band, a tolerance scheme, continuity conditions, a Nyquist slope, single frequency points (e.g. color carrier) or derivatives of slopes (e.g. at the sound shelf) as well as the value to be optimized (e.g. stop band rejection or the amplitude of the color carrier) can be specified. If a solution is possible with respect to the given filter length, the algorithm finds the unique solution for which the specified conditions are satisfied exactly. If no solution is possible, the specifications must be relaxed or the filter length must be extended.

In the filter just designed, none of the secondary order effects of a SAW filter have been taken into account, such as diffraction of the waves due to small radiating apertures (e.g. 0,1 to 15 wavelengths for G 1962 M), the influence of the circuitry (frequency-dependent voltage division on the load resistance), the distribution of electrical charges on the transducer fingers or reflection of the waves at the edges of the fingers.

In the second step of design, these secondary order effects are calculated with the aid of a simulation program and their influence on the transfer function will be corrected by a predistortion in the weighted transducer. This modification of the transducer is performed by a least square optimization program. After compensation for the secondary order effects, the design of the SAW filter is complete, a mask can be made and the filter produced.

### 3 Characteristics

Surface acoustic wave TV IF filters are based on the interference of mechanical surface waves, i.e. on delay effects and not on resonance. This is the reason why some characteristics differ from those of coil filters.

#### 3.1 Feedthrough signals

Surface acoustic wave TV IF filters have a basic delay of approx. 1  $\mu\text{s}$ . If unfavorable circuitry has been selected, it is quite possible for direct electrical feedthrough to be exhibited as a preecho. It is therefore advisable to terminate the filter asymmetrically at its input and symmetrically at its output. Moreover, the input and output circuitry should be appropriately spaced; long filter leads should also be avoided.

#### 3.2 Triple-transit echo (TTE)

The triple-transit echo is an interfering signal typical of surface acoustic wave TV IF filters: the surface acoustic wave from the input transducer is reflected by the output transducer, returns to the input transducer where it is again reflected, and appears as an echo signal at the output with 3-times the basic delay.

In principle, this signal is always present; however its level is not a filter constant, but is a function of the insertion loss, i.e. of internal filter attenuation and the source and load impedances. In practice, it is important to suppress the triple-transit echo at the input by low source impedance. The triple-transit echo virtually does not occur in filters designed for high-impedance loads (e.g. G1962M); if the filter is connected as specified, the TTE signal is prevented by an internal reflection compensation in the output transducer. In filters designed for low-impedance loads the TTE is suppressed by approximately double the insertion attenuation of the filter.

#### 3.3 Reflections (spurious signals)

A transducer emits surface acoustic waves in both directions. The waves impinging on the substrate edge and reflected there can appear as echo signals. For this reason, the substrate edges are provided with an attenuator which absorbs the surface acoustic waves. In this way, reflections are reduced to a non-critical level.

#### 3.4 Pulse response

The interfering effects mentioned above – feedthrough, triple-transit echo and reflections – are echo signals and are therefore in the time domain. During the design stage, such interfering effects will be calculated and kept as small as possible. In order to guarantee excellent picture and sound quality it is therefore important to record the time-domain performance, the so-called pulse response (see 4.3) in production. In the frequency domain such echos cause a ripple in the pass band of the filter. The ripple frequency is proportional to the distance in time and the ripple amplitude is proportional to the amplitude of the echo signal.

## General Technical Information

---

### 3.5 Frequency response

The frequency response complies with the relevant standard or with customer-specific requirements. It can be adjusted to the user's applications, if permitted by the technology, state of the art and chip size. On account of the finite length of the transducers, which corresponds to a time-limited pulse response, the steepness of slope is limited.

Since SAW filters consist of periodic finger structures, the interdigital transducers, these are also active at the harmonics of the basic frequency. However, not all harmonic waves are excited. With G 1962 M, for example, every fourth harmonic wave is excited.

### 3.6 Group delay of TV IF filters

The average group delay complies with the relevant standard or customer-specific requirements and is characterized in the data sheets as follows:

e.g. standard B/G (G 1968 M)

Group delay  $\tau$

Reference frequency	38,90 MHz	
Maximum sag	36,90 MHz	– 90 ns
Color carrier	34,47 MHz	165 ns

The typical value of the group delay ripple in the pass band is specified for filters with constant group delay.

The group delay ripple depends on the echo signals, being proportional to amplitude and delay of the echo signals. Despite small amplitude and low signal power, distant echo signals may therefore lead to a considerable high-frequency group delay ripple without causing any critical phase shifts. Thus a sinusoidal group delay ripple of 100 ns peak-to-peak and a period of 800 kHz ( $\cong 1,25 \mu\text{s}$  echo delay) results in a phase shift of only  $\pm 2^\circ$ . Several non-critical reflections e.g. of 50 dB, in contrast, may add up to a conspicuous group delay ripple of 50 ns. For this reason, specification of the group delay ripple for SAW filters with system-related, distant echo signals is only sensible when a frequency aperture is given. An aperture of 50 kHz is assumed for the group delay diagrams included in the data sheets.

### 3.7 Filter impedances

The input and output impedances of a SAW filter comprise the transducer's basic capacitance, the electrical image of the acoustic wave emission and the influence of the reflection of the waves from other transducers, which cause a ripple.

The transducer impedances are therefore strongly frequency-dependent and, in conjunction with the terminating impedances, can influence the frequency response of the filter. Heavy capacitive loading at the output can, for example, produce slopes in the transfer function. Therefore, the specified terminating impedance for which the filter was designed should be used.

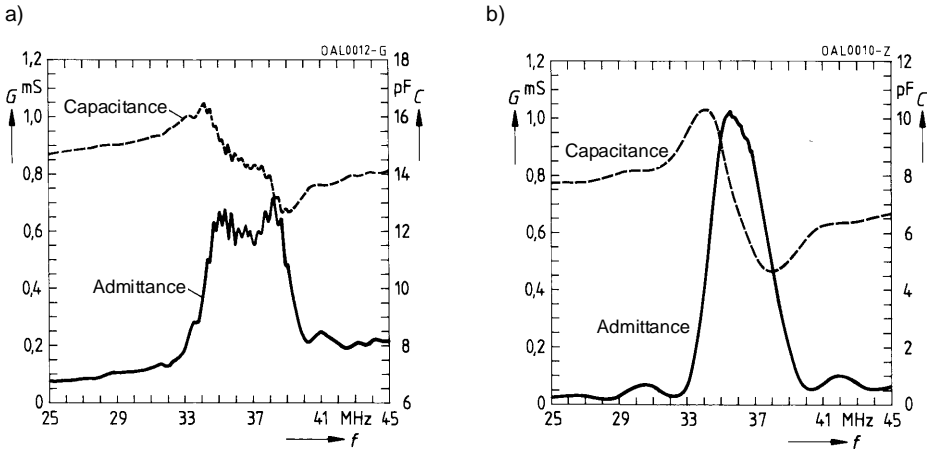

Figure 2

a) Input transducer admittance of G 1968 M  
Output connected to 2 k $\Omega$  in parallel to 3 pF

b) Output transducer admittance of G 1968 M  
Input connected to 50  $\Omega$

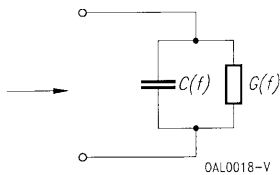

Figure 3

Equivalent circuit diagram  
Filter output  
terminated with 2 k $\Omega$   
in parallel to 3 pF

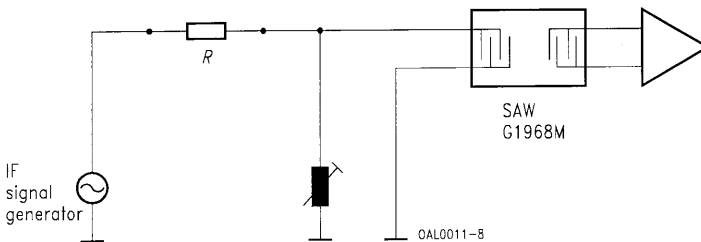

Figure 4

Schematic test circuit for TV IF filters

Adjustment of resonant circuit (inductor and filter input capacitance) to picture carrier (38,9 MHz). Resistor  $R$  is chosen such that the inductor is attenuated by 1 k $\Omega$ , 300  $\Omega$ , 100  $\Omega$  or 30  $\Omega$ .

For information on 2T and step signal refer to para. [4.6](#).

# General Technical Information

The effects of different drive impedances (30 Ω to 1 kΩ) on the pulse response are shown below, using G 1968 M as an example.

x-axis:  
0.5 μs/Div.

1 kΩ

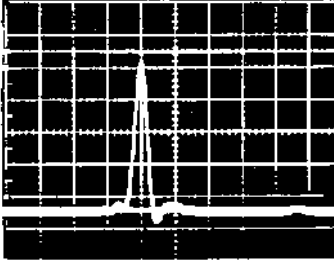
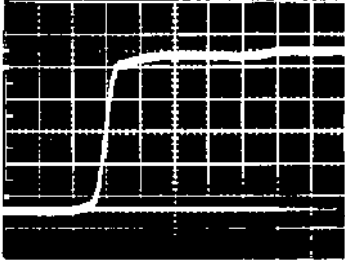

300 Ω

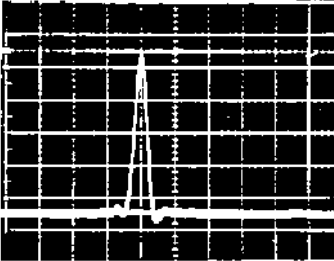
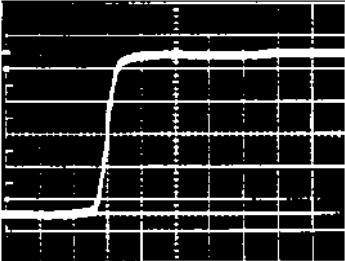

100 Ω

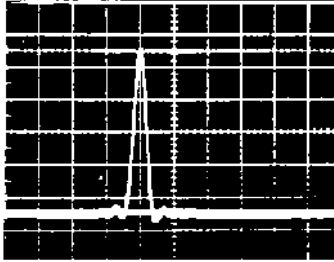
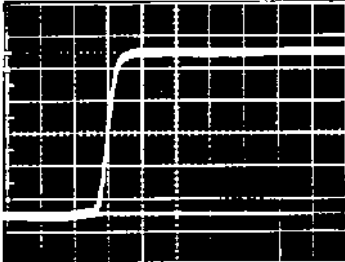

30 Ω

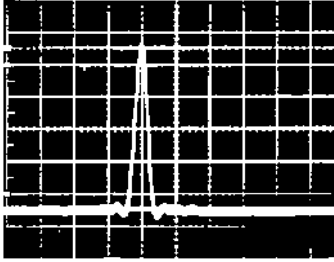
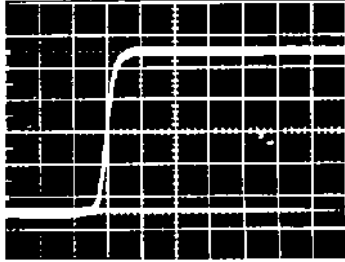

Figure 5  
2T/step signal behavior



The response shown in Figure 5 is typical of many TV IF SAW filters. If the drive impedance is too high, 2T signals and rising edges become fuzzy, and the triple-transit also becomes noticeable (2,3  $\mu$ s after the main pulse). From about 100  $\Omega$  the picture is perfect; a further reduction in drive impedance yields no improvement. We therefore recommend selecting drive impedances for TV IF filters as described in section 5.2. When driver stages with considerably different impedances are used (e.g. > 200  $\Omega$ ), it should be checked which filter types are capable of producing the desired results.

### 3.8 Temperature coefficient of frequency

The temperature coefficient of frequency of a SAW filter is governed by the substrate material or crystal cut. With the lithium niobate Y/Z cut (standard cut), it is  $-94$  ppm/K, and with the 128 Y/X cut (rotated cut) it is  $-72$  ppm/K. The temperature coefficient causes the filter curve to shift towards lower frequencies as the temperature rises. For operation within a TV set, therefore, a frequency variation of the order of  $-50$  kHz will be produced, compared to the frequency at room temperature. With the lithium tantalate 36 Y/X cut (rotated cut) it is  $-30$  ppm/K and with the X/112 Y it is  $-18$  ppm/K.

## 4 Testing

### 4.1 Final measurements

SAW filters are subject to a 100 % final test in specially developed automatic measuring instruments. The RF section of this automatic measuring instrument consists of a network analyzer and a test jig. A computer controls all the data of the filters and determines a set of measured values in the frequency domain and in the time domain that guarantees characteristics which have not been measured directly, as, for example, the 2T response. Thus, minimum measuring time and maximum selectivity are favorably combined in this final measuring process.

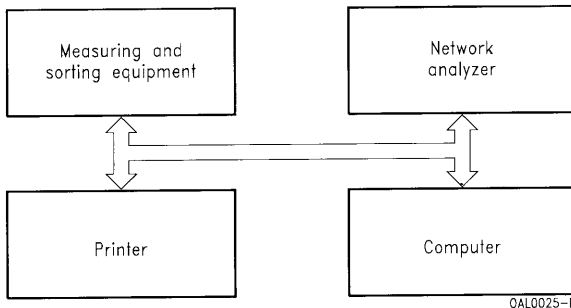

Figure 6  
Computer-controlled test station

### 4.2 Measurement results in the frequency range (e.g. TV IF filter for B/G standard)

#### Insertion attenuation at 37,40 MHz

The attenuation value of the filter at 37,40 MHz is determined in the test circuit (see Figure 10). For this purpose a capacitive short circuit is placed between the outer connections (pins 1 and 5) and the inner connections (pins 2 and 4) instead of the filter; the insertion attenuation of the filter is given relative of the transmitted signal.

# General Technical Information

## Relative attenuation

The attenuation values  $\alpha_{rel}$  given in the data sheets refer to the level at e.g. 37,40 MHz (for B/G standard filters). In the lower/upper sidelobe region, the minimum value of the attenuation is given in each case.

Picture carrier		38,90 MHz	Adjacent stereo sound carrier	40,15 MHz
Color carrier		34,47 MHz	Adjacent sound carrier	VHF 40,40 MHz
Sound carrier		33,40 MHz		UHF 41,40 MHz
Adjacent picture carrier	UHF	30,90 MHz	Lower sidelobe	25,00 ... 31,90 MHz
	VHF	31,90 MHz	Upper sidelobe	40,40 ... 45,00 MHz
FTZ trap		32,40 MHz		

### 4.3 Minimum, maximum and typical values

On account of unavoidable variations in the materials and the process, all measured values show certain scatters that often follow a standard distribution. The minimum and maximum values given in the data book correspond to the measurement limits of the final measurements allowing for uncertainties and which themselves take into account any scatter.

The typical values specified correspond to the 50%-points in the cumulative distribution of the corresponding measurement values. For normal (symmetrical) distributions of measurement values (e.g. in the case of picture carriers, color carriers, sound carriers), the typical value equals the arithmetic mean. In the case of asymmetrically distributed values (e.g. for traps, upper/lower sidelobe), the typical value is generally somewhat smaller than the arithmetic mean.

The values given in the data book have each been determined from a large number of filters. These mean values may, however, also be subject to certain variations.

### 4.4 Pulse response (time-domain measurement)

In order to measure the pulse response, a burst is applied to the filter input and the output voltage is assessed according to the following diagram. Figure 7 shows the schematic envelope curve of the RF output voltage (oscilloscope trace).

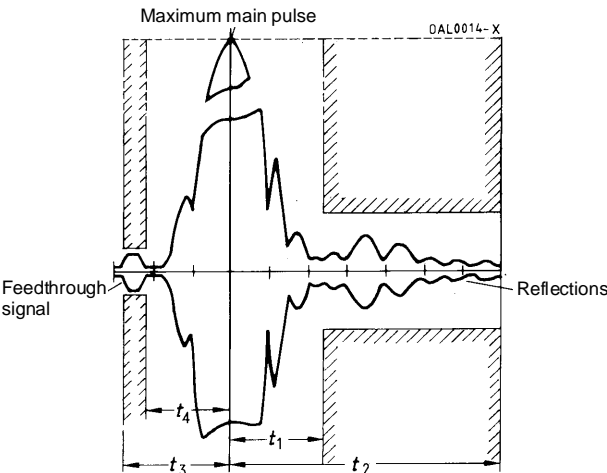

For example

$$t_1 = 1,2 \mu\text{s}$$

$$t_2 = 6,0 \mu\text{s}$$

$$t_3 = 1,4 \mu\text{s}$$

$$t_4 = 1,1 \mu\text{s}$$

Reflections  $\leq -42 \text{ dB}$

Feedthrough

signals  $\leq -50 \text{ dB}$

Figure 7

Envelope curve of the RF output voltage

**4.4.1 Test set-up for TV IF filters**

The circuit shown in Figure 8 allows the pulse response to be measured. In order to obtain the required dynamic range of 70 dB ... 80 dB, the measuring instrument consists of two electronic mixers. Figure 9 shows the burst used: the half pulse width  $t_{hw} = 250$  ns is matched to the filter bandwidth. The exact slope of the pulse is non-critical. The carrier frequency of the pulse is the frequency for which the rated insertion attenuation is specified.

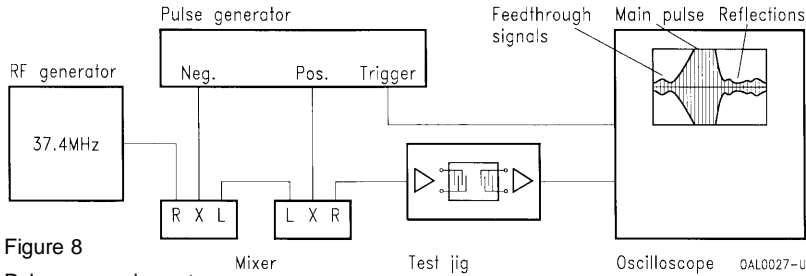
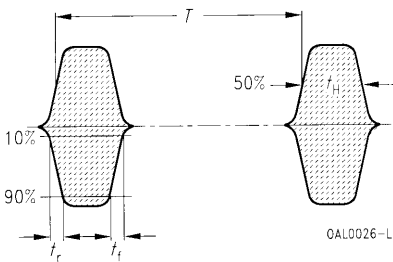

Figure 8  
Pulse measuring set-up



$t_{hw} = 250$  ns  
 $t_r = t_f = 50$  ns  
 $T = 7$   $\mu$ s  
 $f_r =$  Carrier frequency equal to the reference frequency

Figure 9  
Burst pulse

**4.4.2 Method of computation**

In final measurements, a computation process equivalent to one of the methods described above is used to evaluate the transfer function of the filter (measurement values in the frequency range), which is measured by a vectorial network analyzer. For this the complex transfer function is multiplied by the spectrum of the burst and transformed into the time domain by means of a Fourier transform. The amplitude of the transformed signal is evaluated.

**4.5 Test circuits**

For the automatic measuring instrument mentioned in 4.1, special test circuits were designed for TV IF filters; all data sheet information relates to these circuits. Different circuits are used for SIP-5 and DIP-10 filters (Figure 10 and 11). In both cases, wideband drivers with an output impedance of 50  $\Omega$  were used. Filters of all standards can thus be driven without switching or adjustment. Post-amplifiers provide symmetrical filter termination. The test jigs have a common-mode rejection of  $\geq 30$  dB at up to 80 MHz; the frequency response is negligible, and the gain is set to 26 dB. The test jigs are thus fully interchangeable. For all other types of SAW filter, test jigs are used which ensure 50  $\Omega$  drive and load impedance to the SAW filter or the combination SAW filter and matching network respectively.

# General Technical Information

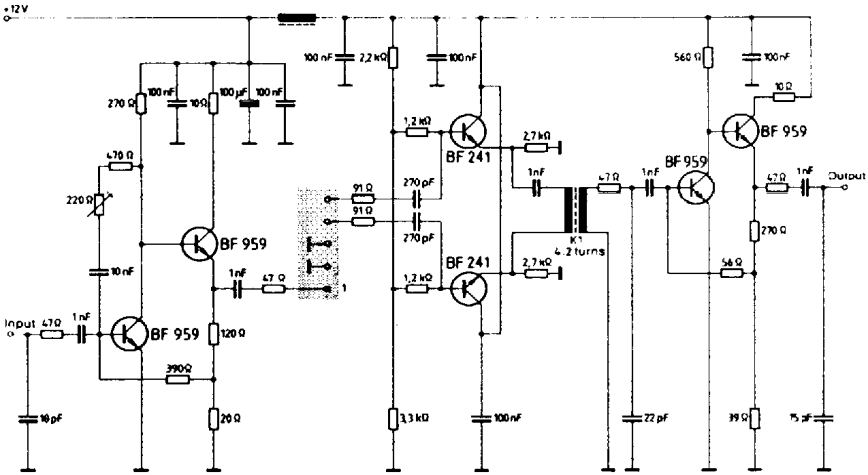

Figure 10

Test circuit for SIP-5 filter

Input impedance of the symmetrical post-amplifier: 2 kΩ in parallel with 3 pF

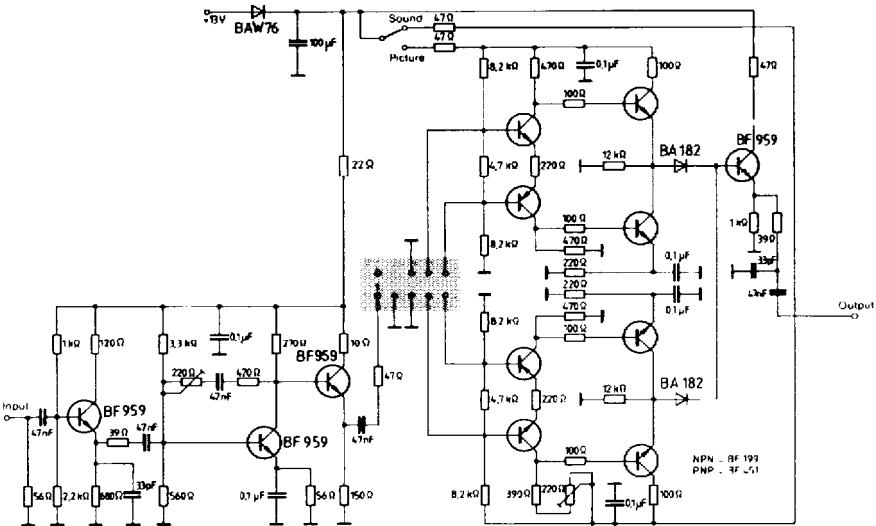

Figure 11

Test circuit for DIP-10 filter

Input impedance of the symmetrical post-amplifier: 2 kΩ in parallel with 5 pF

## 4.6 TV test signals

To check the transmission quality of a TV system, there is a series of special test signals, which in part are continually transmitted by the transmitter in certain lines external to the actual picture. These test signals enable detailed and realistic conclusions to be drawn without special measuring equipment.

To assess a SAW filter, two signals are of particular interest: the 2T signal (also  $\cos^2 2T$  or  $\sin^2 2T$  pulse) and the step signal.

On the screen the **2T signal** corresponds to a vertical white raster line. It approximates a  $\sin^2$ -shaped pulse with a duration (= half-value width) of  $2T = 1/f_c$ , where  $f_c$  is the upper rated cutoff frequency of the video band. For the B/G standard,  $f_c = 5$  MHz, thus resulting in  $2T = 200$  ns. Such a signal has a frequency spectrum lying mainly below  $f_c$ . Clearly stated, the 2T pulse is the shortest signal that can still be processed by the system without distortion.

The oscilloscope picture of the 2T signal, e.g. at the video output of the IF stage, enables the following conclusions to be drawn:

- If the amplitude of the 2T signal is too high or too low, this points to amplitude errors; e.g. a tilt in the pass band of the SAW.
- Unsymmetrical overshoot in front of or behind the 2T signal arises through group delay errors (long wavelength errors, e.g. too little sag).
- Echo signals after the 2T signal point to poor reflection attenuation, e.g. of the triple-transit echo.

Naturally, these errors need not have been caused by the SAW filter. Unfavorable terminating filter impedances, detuned demodulator circuits, transmission errors from previous circuits and amplifiers, as well as power echos can cause the same effects.

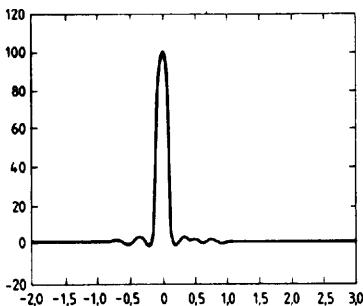

Figure 12  
2T pulse simulated by computation

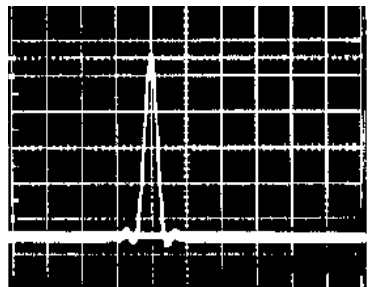

Figure 13  
2T pulse measured on an IF board

# General Technical Information

In the simulated 2T signal shown in Figure 12, the measured transfer function is demodulated whilst taking into account the group delay pre-distortion taken as the basis, by conjugating the transfer function at the Nyquist point, complex mirroring it and summing it. The video frequency response is now obtained, which is multiplied by the spectrum of the 2T pulse; the result is transformed into the time domain. The real component of the transformed signal is the 2T pulse response of the filter.

A figure of merit for the 2T signal is obtained from the K diagram, a tolerance diagram which is based on investigations of the interference effect of various transmission errors. Figure 14 shows the general K tolerance scheme for a 2T signal (time axis applies to the B/G standard).

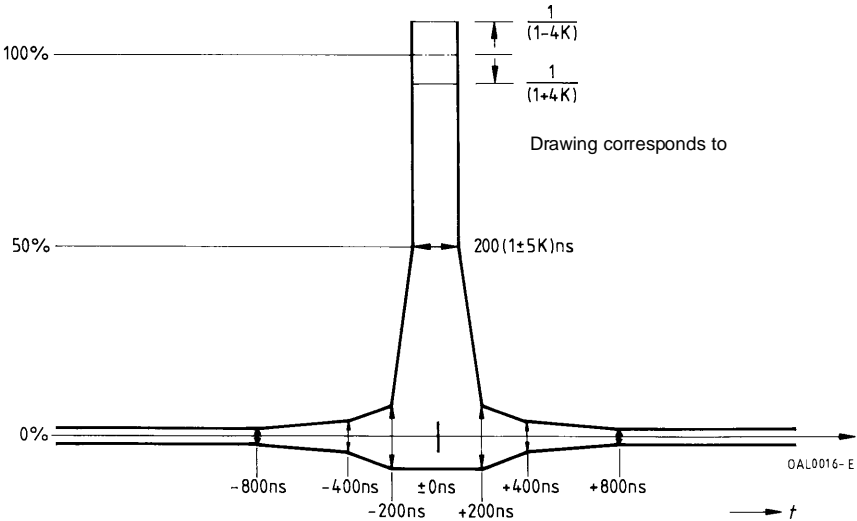

Figure 14  
 K tolerance diagram  
 S + M TV IF SAW filters comply with the  $K = 2\%$  diagram

On the screen the **step signal** corresponds to a wide white bar at the left-hand edge. Mathematically speaking, it is the integral of the 2T signal; in principle, it therefore contains no additional information on the SAW filter. The different representation is often useful in assessing the interference effect of an error in the transmission system (see [3.7](#)).

In general, the following applies: the 2T signal is more suited for assessing a SAW filter, because it responds in a wide band to transmission errors in the pass band region. In addition, it reacts less noticeably to linearity errors in the IF IC and to envelope-curve effects in demodulation that could falsify the step signal more intensely. If reductions in the described errors are desired, to be able to better assess the effects generated by the SAW filter, it is recommended that the modulation factor of the IF modulator be reduced to  $\leq 60\%$ .

5 Application notes for TV IF SAW filters

5.1 Other operating conditions

All filter data quoted in the data sheets apply to the measuring conditions described. It is possible and sometimes necessary to operate the filters under different conditions. If you have any questions please contact your regional sales office. Upon request we are pleased to provide further information material, e.g. overall amplitude and time domain response.

5.2 Matching and driver stage

A low-impedance drive source is required in order to suppress the triple-transit signal. Base resistor  $R_1$  provides the defined input impedance of  $50 \Omega$ . To obtain a wide range of linearity, a drive current of approx. 20 mA is recommended. The gain can be adjusted by  $R_2$ , not lower than  $470 \Omega$  (e.g. 29 dB with  $R_2 = 1,8 \text{ k}\Omega$ ). To guarantee a signal-to-intermodulation ratio of 50 dB, the input voltage  $V_{IN}$  should not exceed 80 mV. The inductivity  $L$  compensates the input capacitances of the SAW filter input and the transistor output.

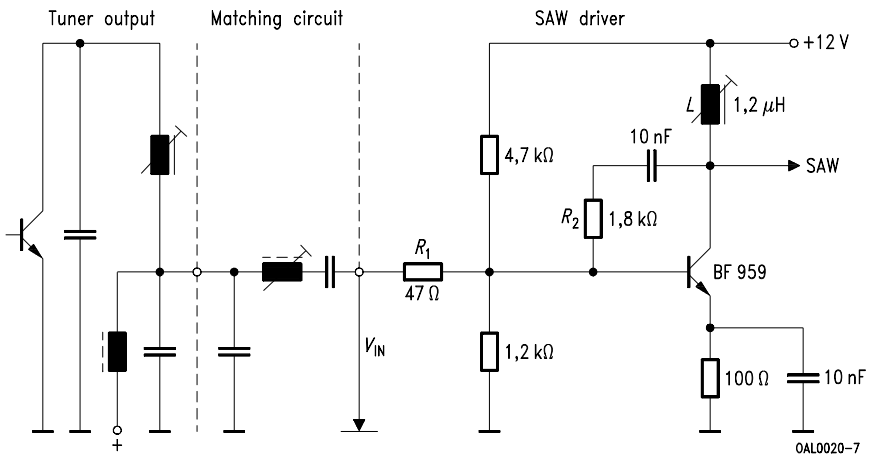

Figure 15  
Tuner IF matching circuit and driver stage

5.3 Switchable video/intercarrier SAW filters for multistandard applications

The family of switchable video/intercarrier filters K 62xx K offers the possibility of switching between two filter characteristics. Figure 16 shows an example of a switching network using an unsymmetrical driver (see above):

To select the first channel the transistor T1 is in off-state and diode D1 connects pin 10 and pin 1. By activating T1 pin 10 is connected to ground and the other filter characteristic is selected.

These filters provide the unique advantage of an optimized frequency response for multistandard concepts using a simple and inexpensive switching network.

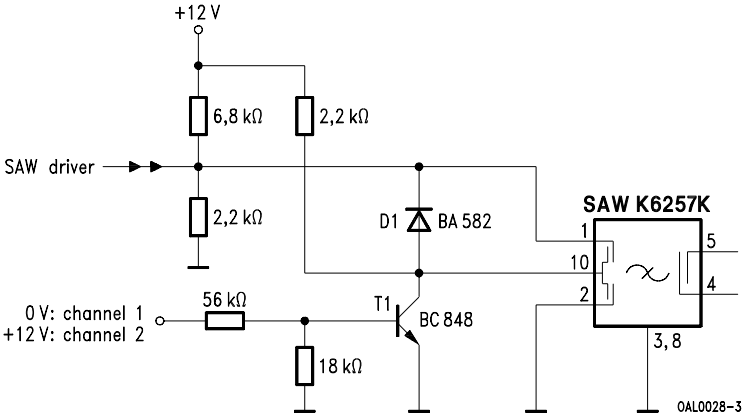

Figure 16  
Switching network for a multistandard video filter

#### 5.4 Switchable audio SAW filters for multistandard applications

Figure 17 shows a proposal for a switchable audio filter for unsymmetrical input. Two different filter characteristics are available in a SIP 5 K package:

To select channel 1 only diode D1 is activated, the corresponding transistor T1 is in off-state. That means that the input is connected to pin 1. Pin 2 is grounded by T2. Channel 2 can be chosen accordingly.

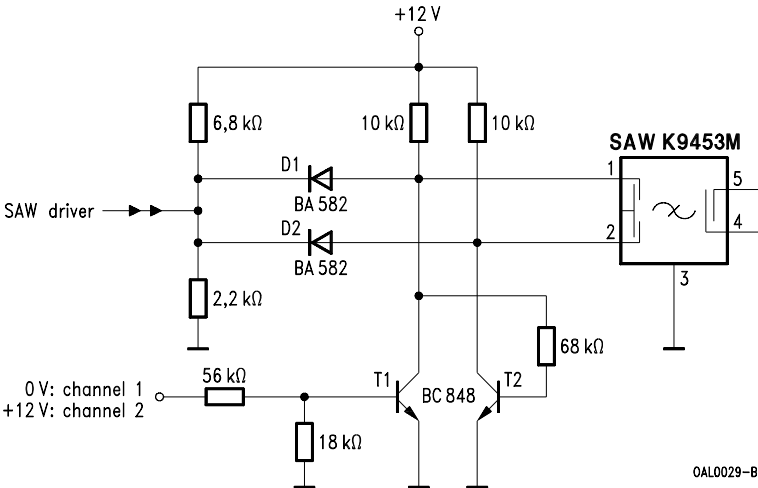

Figure 17  
Switching network for a multistandard audio filter



## 6 Application notes for resonators and resonator filters

Principle: An oscillator is an amplifier with a signal feedback from the output to the input.

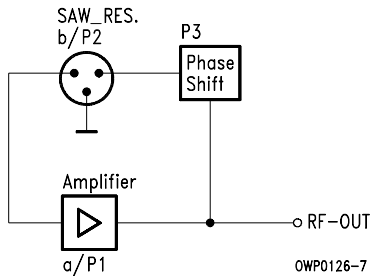

Figure 18  
Basic circuit diagram

To achieve oscillation it is necessary to meet the following conditions:

Amplitude:  $G = a + b > 1$   
 Phase:  $P_{tot} = P1 + P2 + P3 = n \cdot 360$

The amplitude condition means that the total gain  $G$  in the loop is greater than 1 and the phase condition postulates a total phase shift in the oscillator loop of  $n \cdot 360^\circ$ .

### 6.1 Typical oscillation circuits

#### 6.1.1 Oscillators using a one-port resonator

The common base Colpitz circuit is one of the preferably used oscillating circuits for one-port resonators.

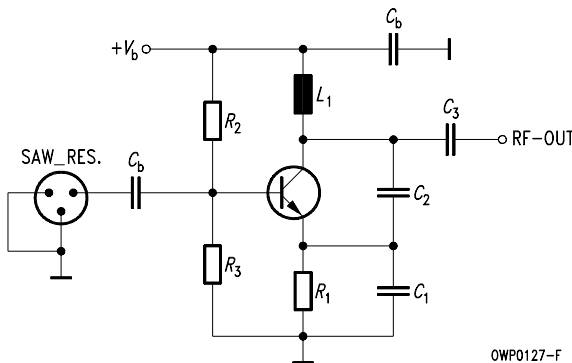

Figure 19  
Colpitz with common base

## General Technical Information

To achieve oscillation, the resonance frequency of the parallel resonance circuit should be near the SAW resonance frequency. Neglecting the internal transistor capacitances, the load and the PCB parasitics, the parallel resonance  $F_p$  of ( $C_1$  serial  $C_2$ ) and  $L_1$  is determined by:

$$F_p = \frac{1}{2 \cdot \pi \cdot \sqrt{L_1 \cdot \frac{C_1 \cdot C_2}{C_1 + C_2}}}$$

$R_1$ ,  $R_2$  and  $R_3$  are for DC biasing.  $C_3$  matches the high collector impedance to the load impedance. The signal feedback depends on the relation of  $C_1$  and  $C_2$ .

The concrete values for  $C_1$ ,  $C_2$ ,  $C_3$  and  $L_1$  must be evaluated on the board to get the desired oscillation frequency.

The SMD transistor should be a high-frequency type with a transit frequency of a few GHz. Often it is possible to design the inductivity  $L_1$  like a copper line on the PCB (without ground on the back-side). So you receive an antenna.

### 6.1.2 Oscillators using a two-port resonator

The typical circuit for two-port resonators is the Pierce oscillator.

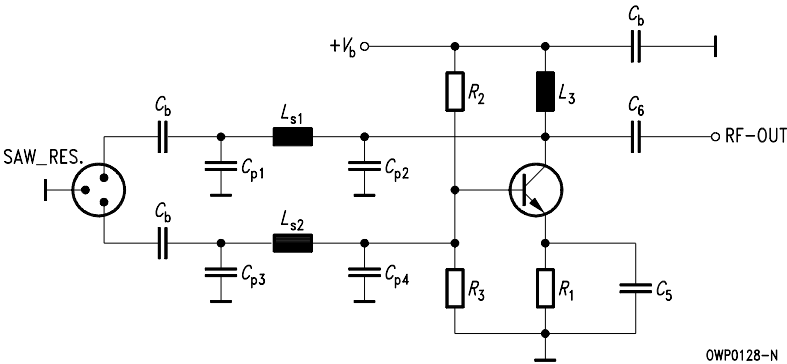

Figure 20  
Pierce oscillator

The amplifier part of the oscillator is a transistor with grounded emitter. The SAW resonator is embedded between two  $\pi$ -type tuning networks. These networks control the phase shift in the feedback loop to meet the oscillation conditions. Otherwise they match the input and output impedance of the transistor to the desired impedance of the SAW resonator.

In the tuning network the parallel capacitors  $C_{p1}$ ,  $C_{p2}$ ,  $C_{p3}$  and  $C_{p4}$  are often substituted by the transistor's and the SAW resonator's input and output capacitors. The phase shift in the oscillating loop is controlled mainly by  $L_{s1}/C_{p1}$  and  $L_{s2}/C_{p3}$ .  $C_6$  is for output matching and  $L_3$  is for DC bypassing.

6.2 Application for a wireless remote control system at 433,92 MHz

Fields of application for SAW resonators are remote control systems for keyless entry, security systems and wireless telemetry.

Figure 21 and Figure 22 show an AM remote control system at 433,92 MHz. The transmitter is a SAW-stabilized oscillator with a PCB antenna, where a one-port SAW resonator is designed in, using the basic circuit of Figure 19. The modulation is OOK (On Off Keying). The receiver is a super-heterodyne receiver with an IF of 10,7 MHz. For preselection and rejection of the image frequency a SAW filter is designed in at the input. The local oscillator is stabilized by a SAW resonator.

For the transmitter and for the receiver it is necessary to provide a good common RF ground and short connections between the RF components. It is also recommended to separate the digital part from the RF part on the PCB. Both circuits are developed for small power consumption.

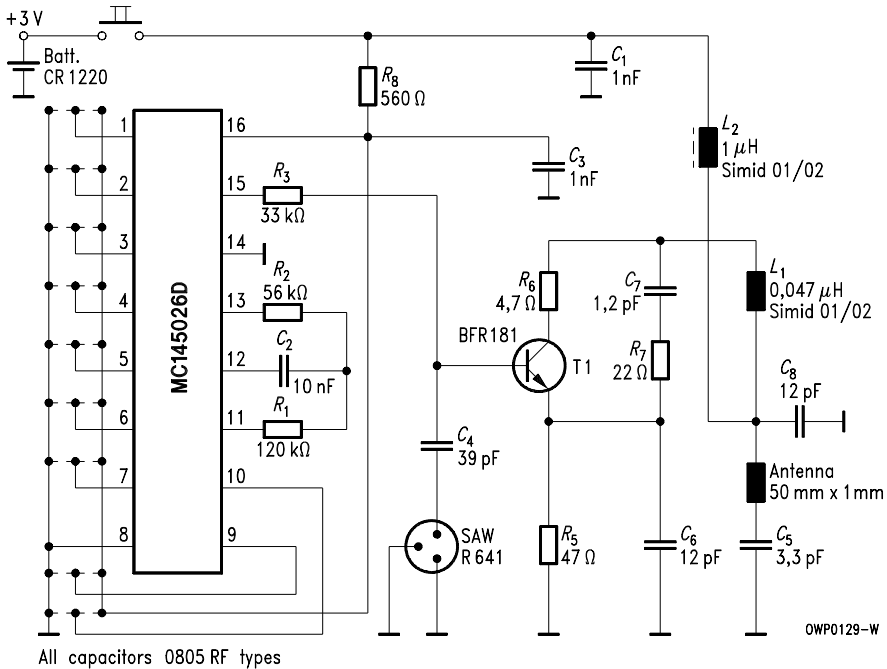

Figure 21  
Remote control transmitter for 433,92 MHz

# General Technical Information

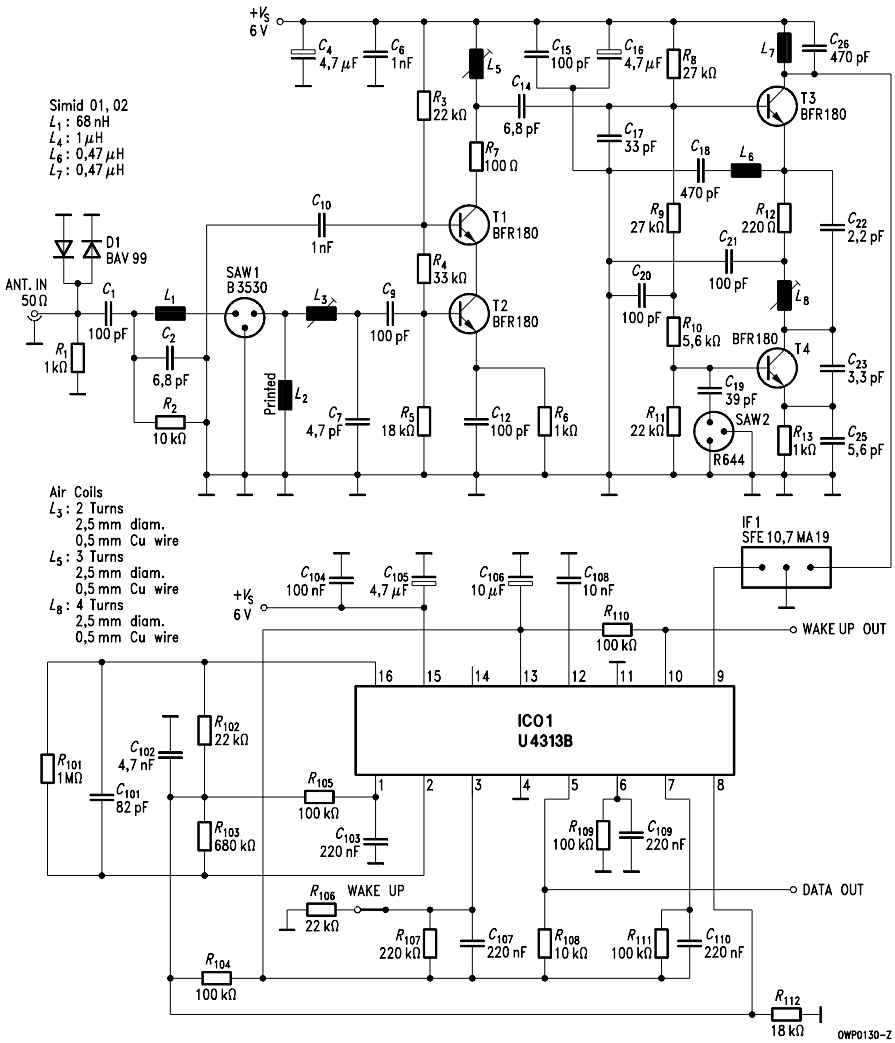

Figure 22  
 Remote control receiver for 433,92 MHz

## 7 Date codes, packing units

### 7.1 Date codes

Date code information (year/month of production) is included in the marking of the SAW filters by using the codes below. As of 1 November 1996 most packages will also be marked with the day of production to enable better traceability. Example: 5H9 = 5 Sept 96

Year	Code	Month	Code	Day	Code	Day	Code
1987	V	January	1	1	1	17	H
1988	W	February	2	2	2	18	J
1989	X	March	3	3	3	19	K
1990	A	April	4	4	4	20	L
1991	B	May	5	5	5	21	M
1992	C	June	6	6	6	22	N
1993	D	July	7	7	7	23	P
1994	E	August	8	8	8	24	R
1995	F	September	9	9	9	25	S
1996	H	October	O	10	0	26	T
1997	J	November	N	11	A	27	U
1998	K	December	D	12	B	28	V
1999	L			13	C	29	W
				14	D	30	X
				15	E	31	Z
				16	F		

### 7.2 Packing units (pcs)

Package code	Package type	Packing unit	Package code	Package type	Packing unit
B110	TO 39	1000	X110	SIP 6 M	300 (75)
B210	TO 39	1000	X210	SIP 4 M	1000
B210 <sup>1)</sup>	TO 39	200 (25)	Z010	QCC 8	3000
B410 <sup>1)</sup>	TO 39	200 (25)	Z110	DCC 14	1500
B510	TO 39	1000	Z210	QCC 22	1500
C210	TO 8	200 (25)	Z310	QCC 18	1500
D210	DIP 14	100 (25)	Z410	QCC 10	1500
E110	DIP 16	100 (25)	Z510	QCC 12	1500
G310	DIP 24-06	80 (20)	M100 (Mxxx)	SIP 5 K	1000
G410	DIP 24-03	80 (20)	K100	DIP 10 K	500
X010	SIP 5 M	400	T901	SIP 5 K SMD	900

1) B55xx Clock recovery filters

## General Technical Information

---

### 8 Quality

#### 8.1 Delivery quality

The term delivery quality designates the conformance with agreed data at the time of delivery.

#### 8.2 Certification

The Quality Management System of the SAW Components Division is certified to ISO 9001. Certification was carried out by the VDE Testing and Certification Institute, Offenbach/Main.

#### 8.3 Qualification

The components are subjected by type groups to a qualifying test procedure, which conforms to all important tests specified in the relevant standards. Types for industrial applications are tested in accordance with MIL-STD-883 and MIL-S-49433. The group of types intended for applications in consumer electronics is tested in accordance with IEC 862-1.

#### 8.4 Classification of defects

A component is considered defective if it does not comply with the specification stated in the data sheets or in an agreed delivery specification. Defectives can be divided into inoperatives, which generally exclude a functional application of the component and defectives of less significance.

Inoperatives are:

- short or open circuit
- broken components, broken package, broken terminals, broken encapsulation
- missing or incorrect marking
- intermixing with other component types

The remaining defectives can be divided into:

- electrical defectives  
(maximum ratings exceeded)
- mechanical defectives  
(incorrect dimensions, damaged package, illegible marking, bent leads)

#### 8.5 Incoming inspection

If the user wishes to carry out an incoming inspection, the use of a sampling inspection plan in accordance with DIN 40 080 (content conforms to MIL-STD 105 D and IEC 410) is recommended.

#### 8.6 Quality data

The information describes the type of component and shall not be considered as assured characteristics. As far as patents or other rights of third parties are concerned, liability is only assumed for the component per se, not for applications, processes and circuits implemented within components or assemblies. Conversely, an agreement as regards quality data does not exclude the possibility of the customer being able to claim replacement for individual defectives within the framework of the terms of delivery.

The following information is required for the assessment of possible claims: test circuit, sample size, number of defectives found, sample defectives.

# IF Filters for Intercarrier Applications

## Survey

Picture carrier	Picture-to-sound carrier distance	Group delay <sup>1)</sup>	Sound carrier rejection <sup>2)</sup>	Standard <sup>3)</sup>	Package	Type	Page <sup>4)</sup>
MHz	MHz		dB				
33,90	- 6,5	F	50	L	SIP 5 K	K 2962 M	<a href="#">90</a>
36,88	5,5	C	20	B	SIP 5 K	B 1952 M	<a href="#">49</a>
38,00	6,5	N	21	D/K	SIP 5 K	D 1952 M	<a href="#">52</a>
	5,5 ... 6,5	C	20, 21	D/K, B/G	SIP 5 K	K 2953 M	<a href="#">55</a>
	5,5 ... 6,5	F	19, 21	D/K, B/G	SIP 5 K	K 2954 M	#
	5,5 ... 6,5	F	20, 20	D/K, B/G	SIP 5 K	K 2958 M	<a href="#">58</a>
	4,5	C	22	M/N	DIP 10 K <sup>5)</sup>	K 6265 K <sup>6)</sup>	<a href="#">61</a>
	5,5 ... 6,5	C	18, 21	D/K, B/G	DIP 10 K <sup>5)</sup>	K 6265 K <sup>6)</sup>	<a href="#">61</a>
38,90	6,5	F	15	D/K	SIP 5 K	D 1990 M	#
	5,5	N	20	B/G	SIP 5 K	G 1872 M	#
	5,5	C	20	B/G	SIP 5 K	G 1875 M	<a href="#">66</a>
	5,5	C	20	B/G	SIP 5 K	G 1960 M	#
	5,5	C	20	B/G	SIP 5 K	G 1961 M	#
	5,5	C	20	B/G	SIP 5 K	G 1962 M	<a href="#">69</a>
	5,5	C	18	B/G	SIP 5 K	G 1963 M	#
	5,5	F	20	B/G	SIP 5 K	G 1965 M	<a href="#">72</a>
	5,5	C	19	B/G	SIP 5 K	G 1966 M	<a href="#">75</a>
	5,5	F	20	B/G	SIP 5 K	G 1967 M	#
	5,5	N	20	B/G	SIP 5 K	G 1968 M	<a href="#">78</a>
	5,5	F	16	B/G	SIP 5 K	G 1980 M	#
	5,5 ... 5,85	C	14, 14	B/G NICAM	SIP 5 K	G 1984 M	#
	6,0	F	20	I	SIP 5 K	J 1952 M	<a href="#">81</a>
	6,0	F	22	I	SIP 5 K	J 1955 M	#
	6,0 ... 6,55	F	14, 14	I NICAM	SIP 5 K	J 1980 M	<a href="#">84</a>
	5,5 ... 6,5	F	21, 21	B/G, D/K	SIP 5 K	K 2951 M	#
	5,5 ... 6,5	C	21, 20	B/G, D/K	SIP 5 K	K 2955 M	<a href="#">87</a>
	5,5 ... 6,5	C	14, 14	B/G, D/K	SIP 5 K	K 2960 M	#
	5,5 ... 6,5	F	15, 15	B/G, D/K	SIP 5 K	K 2962 M	<a href="#">90</a>
	5,5	C	19	B/G	DIP 10 K <sup>5)</sup>	K 6255 K <sup>6)</sup>	<a href="#">93</a>
	6,5	C	20	D/K	DIP 10 K <sup>5)</sup>	K 6255 K <sup>6)</sup>	<a href="#">93</a>
	5,5	C	20	B/G	DIP 10 K <sup>5)</sup>	K 6256 K <sup>6)</sup>	<a href="#">98</a>
	5,5 ... 6,5	C	18, 17	B/G	DIP 10 K <sup>5)</sup>	K 6259 K <sup>6)</sup>	#
	4,5	F	18	M/N	DIP 10 K <sup>5)</sup>	K 6259 K <sup>6)</sup>	#
	5,5	C	16	B/G	DIP 10 K <sup>5)</sup>	K 6260 K <sup>6)</sup>	#
	4,5	F	17	M/N	DIP 10 K <sup>5)</sup>	K 6262 K <sup>6)</sup>	#
4,5	C	21	M/N	SIP 5 K	M 1956 M	#	

continued on next page

1) N: Conforming with standard

C: Customized

F: Flat

2) Typ., referred to filter roof

3) For explanation of standards see individual data sheets or index on page [349](#)

4) Filters marked by the sign # are only listed in the survey. Detailed information on these types upon request.

5) Pin configuration different from standard package

6) Internally switchable multistandard filter

## IF Filters for Intercarrier Applications

### Survey

Picture carrier	Picture-to-sound carrier distance	Group delay <sup>1)</sup>	Sound carrier rejection <sup>2)</sup>	Standard <sup>3)</sup>	Package	Type	Page <sup>4)</sup>
MHz	MHz		dB				
39,50	6,0	F	22	I	SIP 5 K	J 1951 M	<a href="#">103</a>
	6,0	F	20	I	SIP 5 K	J 1953 M	#
45,75	4,5	F	17	M/N	SIP 5 K	M 1859 M	<a href="#">106</a>
	4,5	F	17	M/N	SIP 5 K	M 1861 M	#
	4,5	F	20	M/N	SIP 5 K	M 1958 M	#
	4,5	F	20	M/N	SIP 5 K	M 1962 M	<a href="#">109</a>
	4,5	F	20	M/N	SIP 5 K	M 1963 M	#
	4,5	C	19	M/N	SIP 5 K	M 1966 M	#
58,75	4,5	F	18	M	SIP 5 K	N 1951 M	<a href="#">112</a>

1) N: Conforming with standard  
C: Customized  
F: Flat

2) Typ., referred to filter roof

3) For explanation of standards see individual data sheets or index on page [349](#)

4) Filters marked by the sign # are only listed in the survey. Detailed information on these types upon request.



### Standard

- B-CCIR  
Australia

### Features

- TV IF filter with Nyquist slope and sound shelf
- Customized group delay predistortion

### Terminals

- Tinned CuFe alloy

Plastic package **SIP 5 K**

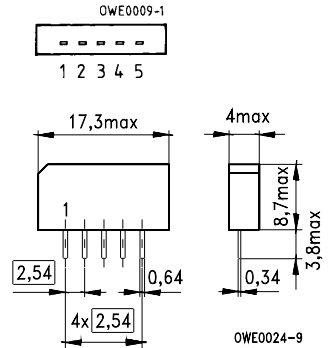

Dimensions in mm, approx. weight 1,0 g

### Pin configuration

- 1 Input
- 2 Input – ground
- 3 Chip carrier – ground
- 4 Output
- 5 Output

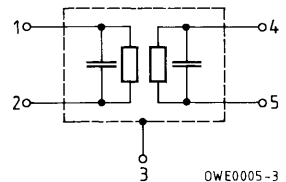

Type	Ordering code	Marking
B 1952 M	B39369-B1952-M100	Type, date code, pin 1

### Maximum ratings

Ambient temperature	$T_A$	- 25/+ 65	°C	—
Storage temperature	$T_{stg}$	- 25/+ 85	°C	—
DC voltage	$V_{DC}$	12	V	between any terminals
AC voltage	$V_{pp}$	10	V	between any terminals

# B 1952 M

## 36,875 MHz

### Characteristics

Ambient temperature	$T_A = 25\text{ °C}$
Source impedance	$Z_S = 50\ \Omega$
Load impedance	$Z_L = 2\text{ k}\Omega \parallel 3\text{ pF}$

		min.	typ.	max.	
<b>Insertion attenuation</b>					
Reference level for the following data	35,38 MHz	15,8	17,3	18,8	dB
<b>Relative attenuation</b>					
Picture carrier	36,88 MHz	4,8	5,8	6,8	dB
Color carrier	32,45 MHz	2,2	3,2	4,2	dB
Sound carrier	31,38 MHz	19,0	20,0	21,0	dB
Adjacent picture carrier	29,88 MHz	46,0	56,0	—	dB
Adjacent sound carrier	38,38 MHz	42,0	56,0	—	dB
Lower sidelobe	25,00 ... 29,88 MHz	40,0	46,0	—	dB
Upper sidelobe	38,38 ... 45,00 MHz	36,0	41,0	—	dB
<b>Reflected wave signal suppression</b>					
1,2 $\mu$ s ... 6,0 $\mu$ s after main pulse (test pulse: 250 ns, carrier frequency: 35,38 MHz)		42,0	52,0	—	dB
<b>Feedthrough signal suppression</b>					
1,2 $\mu$ s ... 1,1 $\mu$ s before main pulse (test pulse: 250 ns, carrier frequency: 35,38 MHz)		50,0	56,0	—	dB
<b>Group delay predistortion</b>					
(reference frequency 36,88 MHz)					
	34,38 MHz	—	-35	—	ns
	32,45 MHz	—	80	—	ns
<b>Impedance at 35,38 MHz</b>					
Input: $Z_{IN} = R_{IN} \parallel C_{IN}$		—	2,3 $\parallel$ 10,8	—	—
Output: $Z_{OUT} = R_{OUT} \parallel C_{OUT}$		—	2,8 $\parallel$ 2,9	—	—
<b>Temperature coefficient of frequency</b>	$TC_f$	—	-72	—	ppm/K

Frequency response

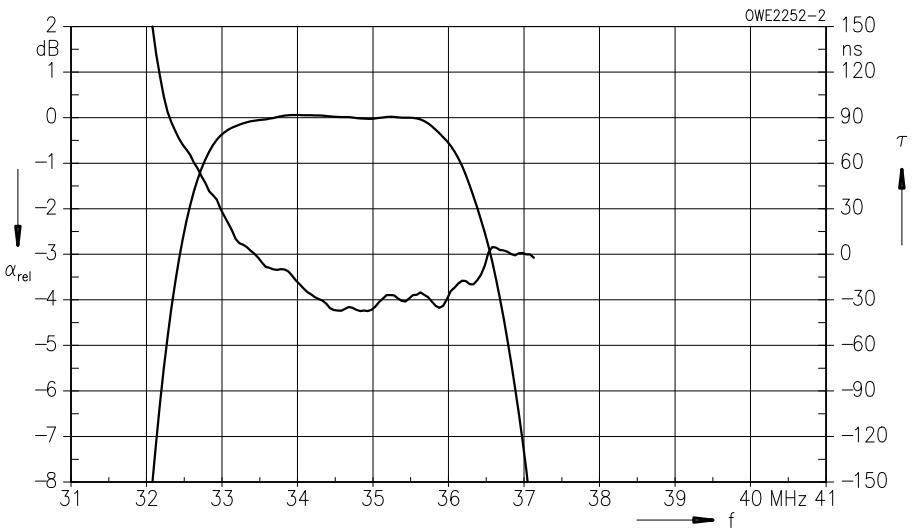
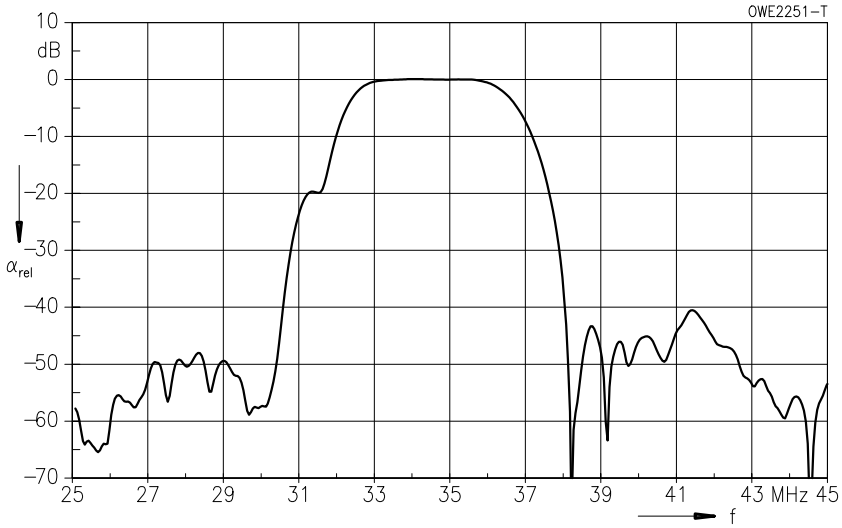

## Standard

- D/K-OIRT  
Eastern standard, China

## Features

- TV IF filter with Nyquist slope and sound shelf
- Group delay predistortion according standard D/K, half, CCIR report 308

## Terminals

- Tinned CuFe alloy

Plastic package **SIP 5 K**

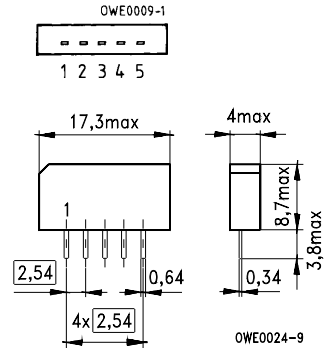

Dimensions in mm, approx. weight 1,0 g

## Pin configuration

- 1 Input
- 2 Input – ground
- 3 Chip carrier – ground
- 4 Output
- 5 Output

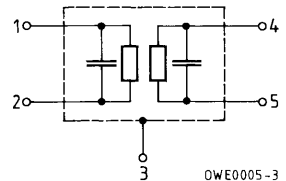

Type	Ordering code	Marking
D 1952 M	B39380-D1952-M100	Type, date code, pin 1

## Maximum ratings

Ambient temperature	$T_A$	- 25/+ 65	°C	—
Storage temperature	$T_{stg}$	- 25/+ 85	°C	—
DC voltage	$V_{DC}$	12	V	between any terminals
AC voltage	$V_{pp}$	10	V	between any terminals

**Characteristics**

Ambient temperature  $T_A = 25\text{ °C}$   
 Source impedance  $Z_S = 50\ \Omega$   
 Load impedance  $Z_L = 2\text{ k}\Omega \parallel 3\text{ pF}$

		min.	typ.	max.		
<b>Insertion attenuation</b>						
Reference level for the following data	35,00 MHz	$\alpha$	15,0	16,7	18,0	dB
<b>Relative attenuation</b>						
Picture carrier	38,00 MHz	$\alpha_{rel}$	4,3	5,3	6,3	dB
Color carrier	33,57 MHz		0,3	1,3	2,3	dB
Sound carrier	31,50 MHz		19,7	20,7	21,7	dB
Adjacent picture carrier	30,00 MHz		46,0	51,0	—	dB
Adjacent sound carrier	39,50 MHz		44,0	52,0	—	dB
Lower sidelobe	25,00 ... 30,00 MHz		41,0	45,0	—	dB
Upper sidelobe	39,50 ... 45,00 MHz		35,0	39,0	—	dB
<b>Reflected wave signal suppression</b>						
1,2 $\mu$ s ... 6,0 $\mu$ s after main pulse (test pulse: 250 ns, carrier frequency: 35,00 MHz)			44,0	55,0	—	dB
<b>Feedthrough signal suppression</b>						
1,0 $\mu$ s ... 0,9 $\mu$ s before main pulse (test pulse: 250 ns, carrier frequency: 35,00 MHz)			50,0	56,0	—	dB
<b>Group delay predistortion</b>						
(reference frequency 38,00 MHz)		$\Delta\tau$				
	35,60 MHz		—	-60	—	ns
	33,57 MHz		—	5	—	ns
<b>Impedance at 35,00 MHz</b>						
Input: $Z_{IN} = R_{IN} \parallel C_{IN}$			—	2,8 $\parallel$ 12,0	—	k $\Omega$ $\parallel$ pF
Output: $Z_{OUT} = R_{OUT} \parallel C_{OUT}$			—	1,5 $\parallel$ 5,5	—	k $\Omega$ $\parallel$ pF
<b>Temperature coefficient of frequency</b>						
		$TC_f$	—	-72	—	ppm/K

Frequency response

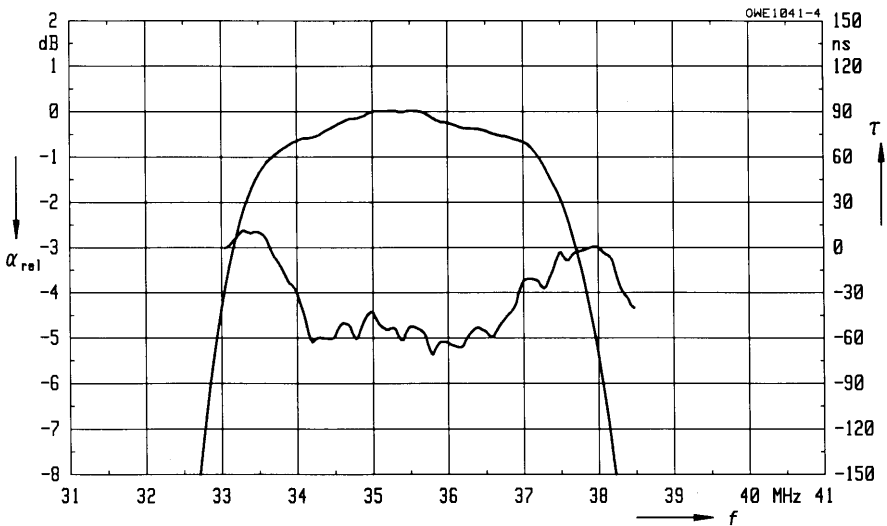
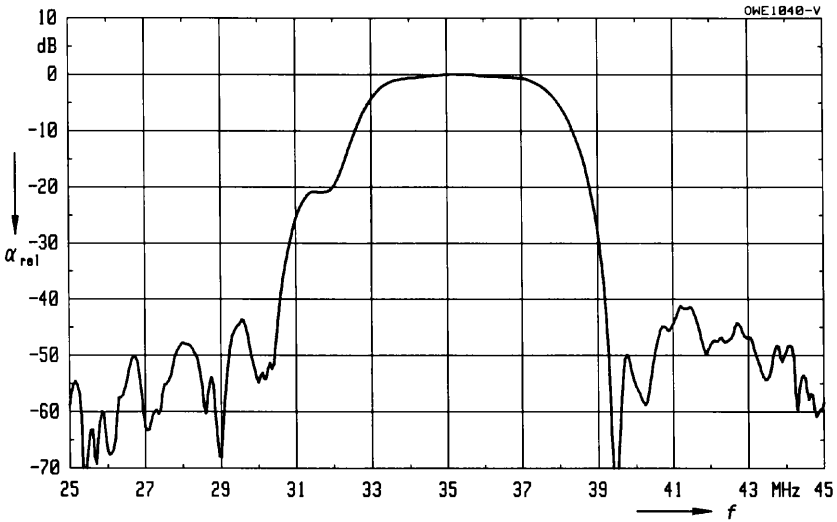

## Standard

- D/K-OIRT  
Eastern standard
- B/G-CCIR  
Europe partly

## Features

- TV IF filter with Nyquist slope and sound shelf
- Broad sound shelf for sound carriers at 31,50 MHz and 32,50 MHz
- Customized group delay predistortion

## Terminals

- Tinned CuFe alloy

Plastic package **SIP 5 K**

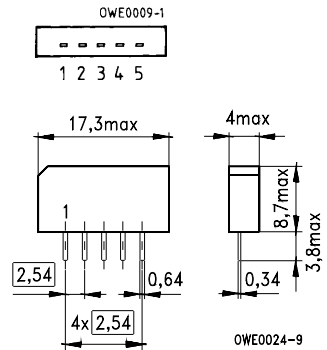

Dimensions in mm, approx. weight 1,0 g

## Pin configuration

- 1 Input
- 2 Input – ground
- 3 Chip carrier – ground
- 4 Output
- 5 Output

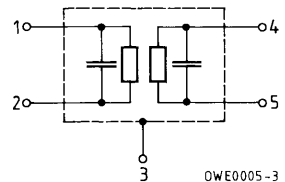

Type	Ordering code	Marking
K 2953 M	B39380-K2953-M100	Type, date code, pin 1

## Maximum ratings

Ambient temperature	$T_A$	- 25/+ 65	°C	–
Storage temperature	$T_{stg}$	- 25/+ 85	°C	–
DC voltage	$V_{DC}$	12	V	between any terminals
AC voltage	$V_{pp}$	10	V	between any terminals

# K 2953 M

## 38,00 MHz

### Characteristics

Ambient temperature	$T_A = 25\text{ °C}$
Source impedance	$Z_S = 50\ \Omega$
Load impedance	$Z_L = 2\text{ k}\Omega \parallel 3\text{ pF}$

		min.	typ.	max.	
<b>Insertion attenuation</b>					
Reference level for the following data	36,50 MHz	14,8	16,3	17,8	dB
<b>Relative attenuation</b>					
Picture carrier	38,00 MHz	4,4	5,4	6,4	dB
Color carrier	33,57 MHz	2,1	3,1	4,1	dB
	33,20 MHz	—	8,8	—	dB
Sound carrier	31,50 MHz	—	20,6	—	dB
	32,50 MHz	18,6	19,6	20,6	dB
Adjacent picture carrier	30,00 MHz	46,0	55,0	—	dB
Adjacent sound carrier	39,50 MHz	44,0	53,0	—	dB
Lower sidelobe	25,00 ... 30,00 MHz	39,0	46,0	—	dB
Upper sidelobe	39,50 ... 45,00 MHz	36,0	43,0	—	dB
<b>Reflected wave signal suppression</b>					
1,1 $\mu$ s ... 6,0 $\mu$ s after main pulse (test pulse: 250 ns, carrier frequency: 36,50 MHz)		44,0	55,0	—	dB
<b>Feedthrough signal suppression</b>					
1,1 $\mu$ s ... 1,0 $\mu$ s before main pulse (test pulse: 250 ns, carrier frequency: 36,50 MHz)		50,0	56,0	—	dB
<b>Group delay pre-distortion</b>					
(reference frequency 38,00 MHz)					
	34,20 MHz	—	- 85	—	ns
	33,57 MHz	—	- 30	—	ns
<b>Impedance at 36,50 MHz</b>					
Input: $Z_{IN} = R_{IN} \parallel C_{IN}$		—	1,4 $\parallel$ 13,2	—	k $\Omega$ $\parallel$ pF
Output: $Z_{OUT} = R_{OUT} \parallel C_{OUT}$		—	2,5 $\parallel$ 4,0	—	k $\Omega$ $\parallel$ pF
<b>Temperature coefficient of frequency</b>					
	$TC_f$	—	- 72	—	ppm/K



Frequency response

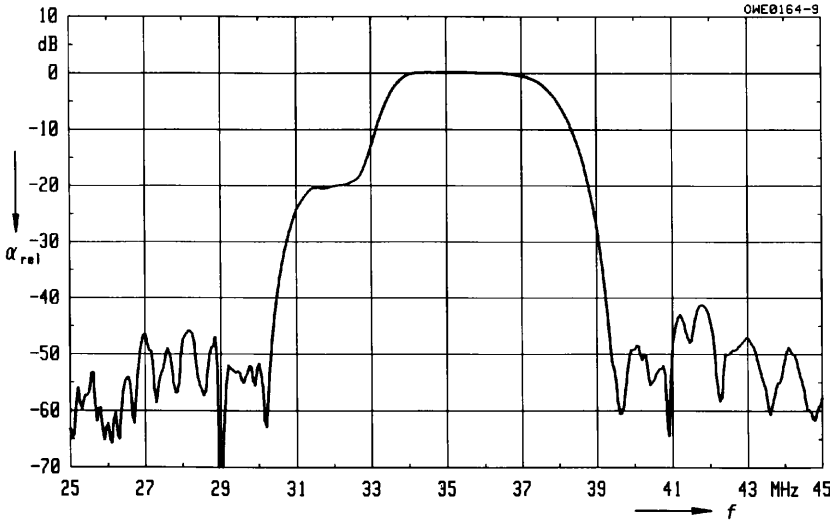

### Standard

- D/K-OIRT  
Eastern standard
- B/G-CCIR  
Europe partly

### Features

- TV IF filter with Nyquist slope and sound shelf
- Broad sound shelf for sound carriers  
at 31,50 MHz and 32,50 MHz
- High color carrier level
- Constant group delay

### Terminals

- Tinned CuFe alloy

Plastic package **SIP 5 K**

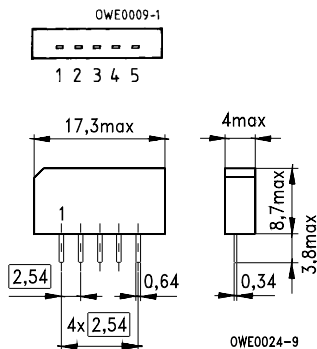

Dimensions in mm, approx. weight 1,0 g

### Pin configuration

- 1 Input
- 2 Input – ground
- 3 Chip carrier – ground
- 4 Output
- 5 Output

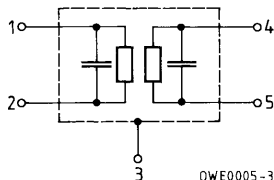

Type	Ordering code	Marking
K 2958 M	B39380-K2958-M100	Type, date code, pin 1

### Maximum ratings

Ambient temperature	$T_A$	- 25/+ 65	°C	—
Storage temperature	$T_{stg}$	- 25/+ 85	°C	—
DC voltage	$V_{DC}$	12	V	between any terminals
AC voltage	$V_{pp}$	10	V	between any terminals

**Characteristics**

Ambient temperature  $T_A = 25\text{ °C}$   
 Source impedance  $Z_S = 50\ \Omega$   
 Load impedance  $Z_L = 2\text{ k}\Omega \parallel 3\text{ pF}$

		min.	typ.	max.		
<b>Insertion attenuation</b>						
Reference level for the following data	36,50 MHz	$\alpha$	16,1	17,6	19,1	dB
<b>Relative attenuation</b>						
Picture carrier	38,00 MHz	$\alpha_{rel}$	5,0	6,0	7,0	dB
Color carrier	33,57 MHz		0,4	1,4	2,4	dB
Sound carrier	31,50 MHz		18,7	20,2	21,7	dB
	32,50 MHz		18,3	19,8	21,3	dB
Adjacent picture carrier	30,00 MHz		46,0	60,0	—	dB
Adjacent sound carrier	39,50 MHz		42,0	55,0	—	dB
Lower sidelobe	25,00 ... 30,00 MHz		41,0	47,0	—	dB
Upper sidelobe	39,50 ... 45,00 MHz		37,0	43,0	—	dB
<b>Reflected wave signal suppression</b>						
1,1 $\mu$ s ... 6,0 $\mu$ s after main pulse (test pulse: 250 ns, carrier frequency: 36,50 MHz)			42,0	52,0	—	dB
<b>Feedthrough signal suppression</b>						
1,1 $\mu$ s ... 1,0 $\mu$ s before main pulse (test pulse: 250 ns, carrier frequency: 36,50 MHz)			50,0	56,0	—	dB
<b>Group delay ripple (p-p)</b>		$\Delta\tau$	—	50	—	ns
<b>Impedance at 36,50 MHz</b>						
Input: $Z_{IN} = R_{IN} \parallel C_{IN}$			—	2,1 $\parallel$ 11,0	—	k $\Omega$ $\parallel$ pF
Output: $Z_{OUT} = R_{OUT} \parallel C_{OUT}$			—	4,3 $\parallel$ 2,7	—	k $\Omega$ $\parallel$ pF
<b>Temperature coefficient of frequency</b>		$TC_f$	—	-72	—	ppm/K

**Frequency response**

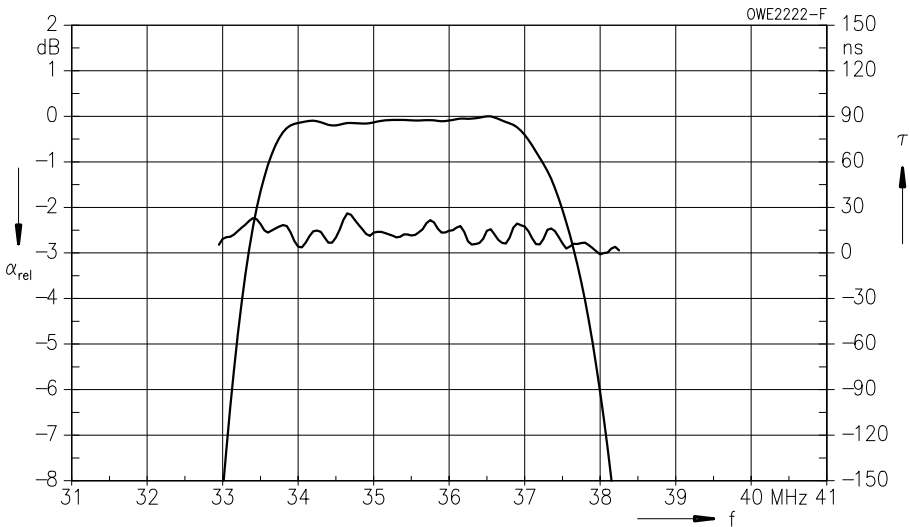
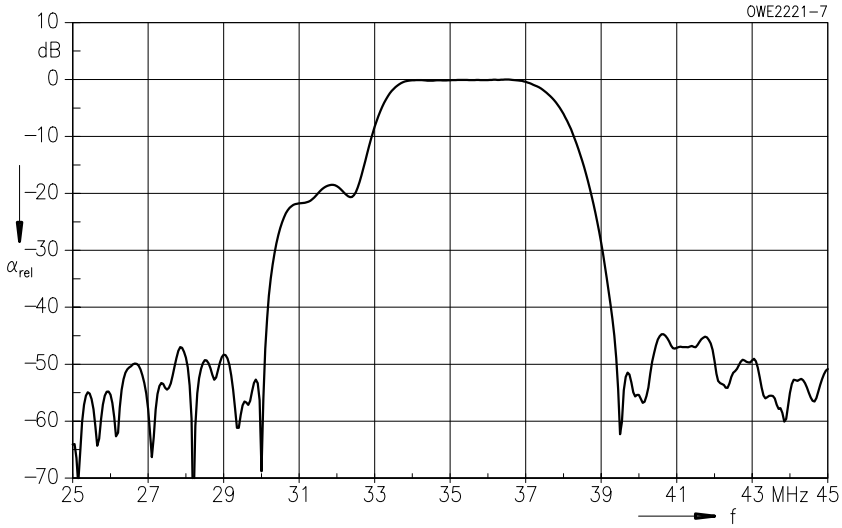

### Standard

- D/K-OIRT  
Eastern standard
- B/G-CCIR  
Europe partly
- M/N-FCC  
USA

Plastic package DIP 10 K

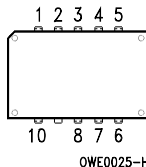

### Features

- TV IF filter switchable from M/N mode to D/K mode
- M/N mode with Nyquist slope and sound shelf at 33,50 MHz
- Customized group delay predistortion
- D/K mode with Nyquist slope and broad sound shelf for sound carriers at 31,50 MHz and 32,50 MHz
- Customized group delay predistortion

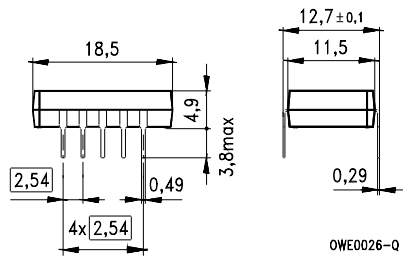

### Terminals

- Tinned CuFe alloy

Dimensions in mm, approx. weight 1,8 g

### Pin configuration

- 1 Input
- 2 Input – ground
- 3, 8 Chip carrier – ground
- 4, 5 Output
- 6, 7 Not connected
- 9 Free
- 10 Switching input

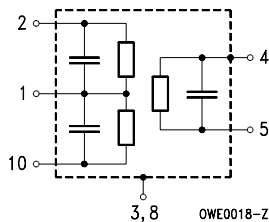

Type	Ordering code	Marking
K 6265 K	B39380-K6265-K100	Type, date code, pin 1

### Maximum ratings

Ambient temperature	$T_A$	- 25/+ 65	°C	—
Storage temperature	$T_{stg}$	- 25/+ 85	°C	—
DC voltage	$V_{DC}$	12	V	between any terminals
AC voltage	$V_{pp}$	10	V	between any terminals

# K 6265 K

## 38,00 MHz

### Characteristics in M/N mode (switching input pin 10 connected to input pin 1)

Ambient temperature  $T_A = 25\text{ °C}$   
 Source impedance  $Z_S = 50\ \Omega$   
 Load impedance  $Z_L = 2\text{ k}\Omega \parallel 3\text{ pF}$

		min.	typ.	max.	
<b>Insertion attenuation</b>					
Reference level for the following data	36,50 MHz	15,4	16,9	18,4	dB
<b>Relative attenuation</b>					
Picture carrier	38,00 MHz	5,0	6,0	7,0	dB
Color carrier	34,42 MHz	4,6	5,6	6,6	dB
Sound carrier	33,50 MHz	20,0	22,0	24,0	dB
Adjacent picture carrier	32,00 MHz	37,0	43,0	—	dB
Adjacent sound carrier	39,50 MHz	46,0	60,0	—	dB
Lower sidelobe	25,00 ... 32,00 MHz	35,0	41,0	—	dB
Upper sidelobe	39,50 ... 45,00 MHz	38,0	45,0	—	dB
<b>Reflected wave signal suppression</b>					
1,2 $\mu$ s ... 6,0 $\mu$ s after main pulse (test pulse: 250 ns, carrier frequency: 36,50 MHz)		42,0	49,0	—	dB
<b>Feedthrough signal suppression</b>					
1,3 $\mu$ s ... 1,2 $\mu$ s before main pulse (test pulse: 250 ns, carrier frequency: 36,50 MHz)		—	56,0	—	dB
<b>Group delay predistortion</b>					
(reference frequency 38,00 MHz)					
	36,00 MHz	—	0	—	ns
	34,42 MHz	—	0	—	ns
<b>Impedance at 36,50 MHz</b>					
Input: $Z_{IN} = R_{IN} \parallel C_{IN}$		—	0,9 $\parallel$ 21,7	—	k $\Omega$ $\parallel$ pF
Output: $Z_{OUT} = R_{OUT} \parallel C_{OUT}$		—	1,4 $\parallel$ 5,9	—	k $\Omega$ $\parallel$ pF
<b>Temperature coefficient of frequency</b>					
	$TC_f$	—	-72	—	ppm/K

Frequency response (M/N mode)

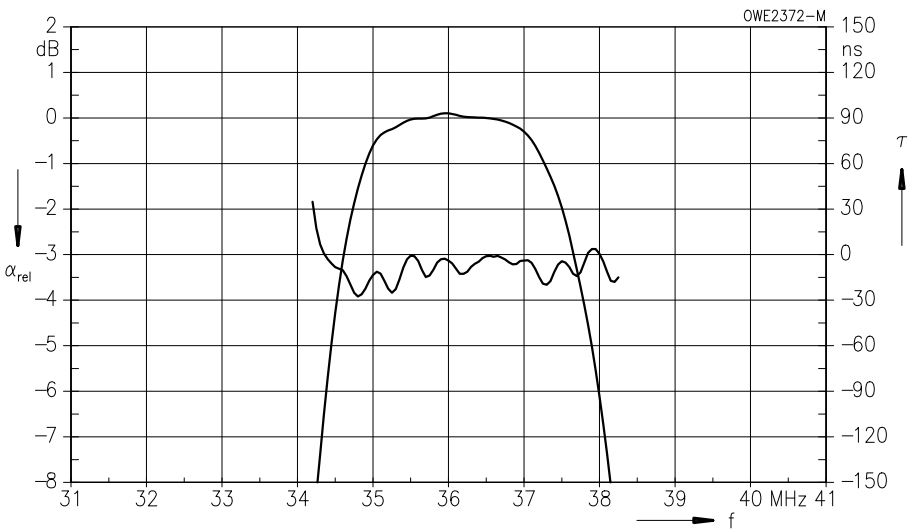
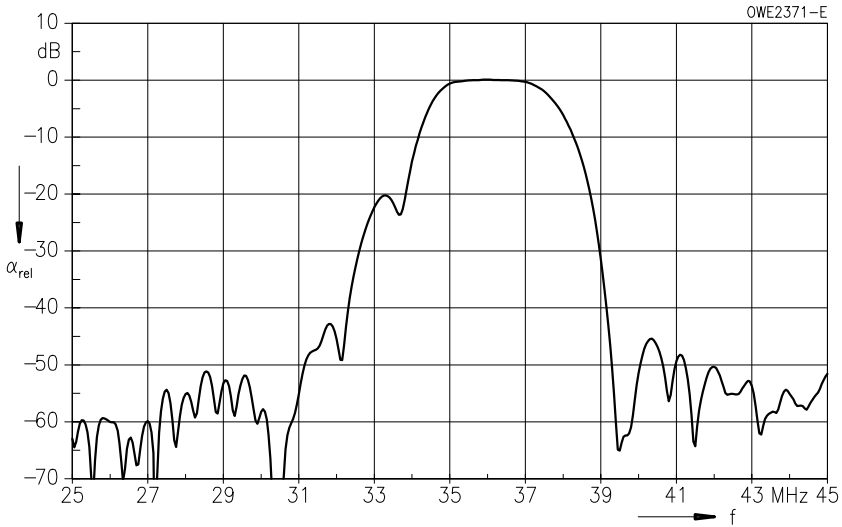

# K 6265 K

## 38,00 MHz

### Characteristics in D/K mode (switching input pin 10 connected to ground input pin 2)

Ambient temperature  $T_A = 25\text{ °C}$   
 Source impedance  $Z_S = 50\ \Omega$   
 Load impedance  $Z_L = 2\text{ k}\Omega \parallel 3\text{ pF}$

		min.	typ.	max.	
<b>Insertion attenuation</b>					
Reference level for the following data	36,50 MHz	$\alpha$ 15,3	16,8	18,3	dB
<b>Relative attenuation</b>					
Picture carrier	38,00 MHz	$\alpha_{rel}$ 5,3	6,3	7,3	dB
Color carrier	33,57 MHz	0,8	1,8	2,8	dB
Sound carrier	31,50 MHz	18,7	20,7	22,7	dB
	32,50 MHz	15,9	17,9	19,9	dB
Adjacent picture carrier	30,00 MHz	46,0	54,0	—	dB
	31,00 MHz	40,0	50,0	—	dB
Adjacent sound carrier	39,50 MHz	44,0	55,0	—	dB
Lower sidelobe	25,00 ... 30,00 MHz	39,0	45,0	—	dB
Upper sidelobe	39,50 ... 45,00 MHz	37,0	43,0	—	dB
<b>Reflected wave signal suppression</b>					
1,2 $\mu$ s ... 6,0 $\mu$ s after main pulse (test pulse: 250 ns, carrier frequency: 36,50 MHz)		42,0	50,0	—	dB
<b>Feedthrough signal suppression</b>					
1,3 $\mu$ s ... 1,2 $\mu$ s before main pulse (test pulse: 250 ns, carrier frequency: 36,50 MHz)		—	56,0	—	dB
<b>Group delay pre-distortion</b>					
(reference frequency 38,00 MHz)		$\Delta\tau$			
	34,50 MHz	—	- 80	—	ns
	33,57 MHz	—	- 20	—	ns
<b>Impedance at 36,50 MHz</b>					
Input: $Z_{IN} = R_{IN} \parallel C_{IN}$		—	0,6 $\parallel$ 27,0	—	$\text{k}\Omega \parallel \text{pF}$
Output: $Z_{OUT} = R_{OUT} \parallel C_{OUT}$		—	1,4 $\parallel$ 5,9	—	$\text{k}\Omega \parallel \text{pF}$
<b>Temperature coefficient of frequency</b>					
		$TC_f$	- 72	—	ppm/K



**Frequency response (D/K mode)**

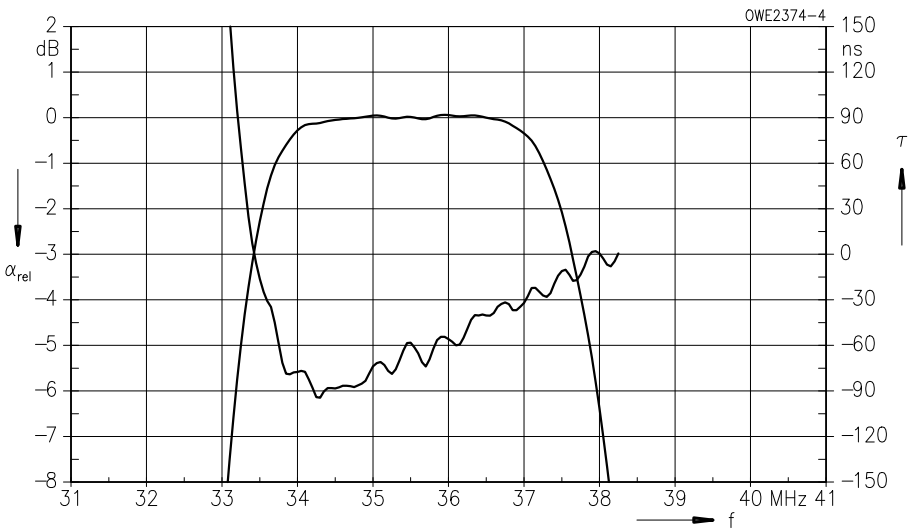
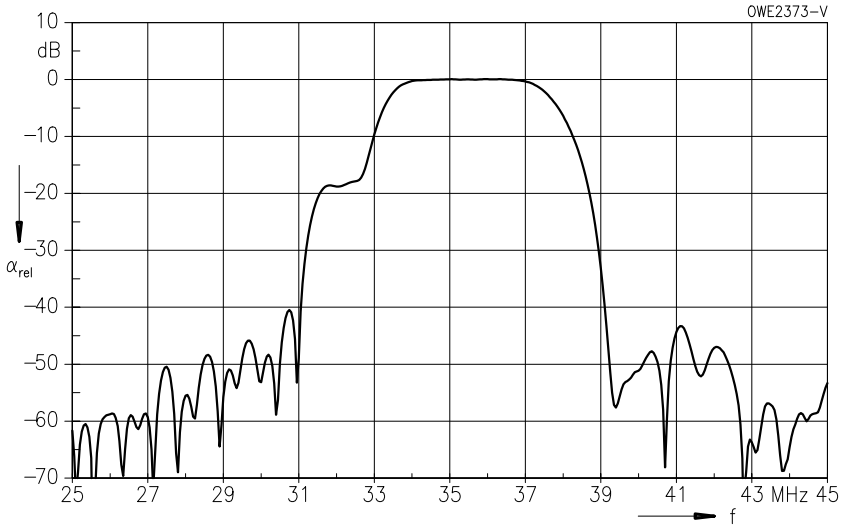

### Standard

- B/G-CCIR  
Germany, Europe partly

### Features

- TV IF filter with Nyquist slope and sound shelf
- Reduced group delay predistortion as compared with standard B/G, half

### Terminals

- Tinned CuFe alloy

Plastic package **SIP 5 K**

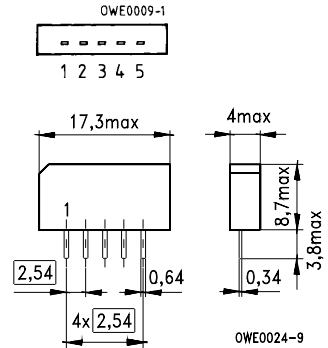

Dimensions in mm, approx. weight 1,0 g

### Pin configuration

- 1 Input
- 2 Input – ground
- 3 Chip carrier – ground
- 4 Output
- 5 Output

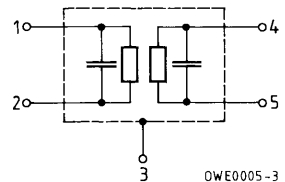

Type	Ordering code	Marking
G 1875 M	B39389-G1875-M100	Type, date code, pin 1

### Maximum ratings

Ambient temperature	$T_A$	- 25/+ 65	°C	–
Storage temperature	$T_{stg}$	- 25/+ 85	°C	–
DC voltage	$V_{DC}$	12	V	between any terminals
AC voltage	$V_{pp}$	10	V	between any terminals

**Characteristics**

Ambient temperature  $T_A = 25\text{ }^\circ\text{C}$   
 Source impedance  $Z_S = 50\ \Omega$   
 Load impedance  $Z_L = 2\ \text{k}\Omega \parallel 3\ \text{pF}$

		min.	typ.	max.	
<b>Insertion attenuation</b>					
Reference level for the following data	37,40 MHz	$\alpha$ 16,9	17,4	18,9	dB
<b>Relative attenuation</b>					
Picture carrier	38,90 MHz	$\alpha_{\text{rel}}$ 4,5	5,5	6,5	dB
Color carrier	34,47 MHz	1,6	2,6	3,6	dB
Sound carrier	33,40 MHz	18,7	19,7	20,7	dB
Adjacent picture carrier	UHF 30,90 MHz	44,0	55,0	—	dB
	VHF 31,90 MHz	44,0	57,0	—	dB
Adjacent sound carrier	VHF 40,15 MHz	36,0	44,0	—	dB
	VHF 40,40 MHz	40,0	50,0	—	dB
Lower sidelobe	UHF 41,40 MHz	40,0	50,0	—	dB
	25,00 ... 31,90 MHz	40,0	47,0	—	dB
Upper sidelobe	40,40 ... 45,00 MHz	36,0	43,0	—	dB
<b>Reflected wave signal suppression</b>					
1,0 $\mu\text{s}$ ... 6,0 $\mu\text{s}$ after main pulse (test pulse: 250 ns, carrier frequency: 37,40 MHz)		42,0	52,0	—	dB
<b>Feedthrough signal suppression</b>					
1,0 $\mu\text{s}$ ... 0,9 $\mu\text{s}$ before main pulse (test pulse: 250 ns, carrier frequency: 37,40 MHz)		50,0	56,0	—	dB
<b>Group delay predistortion</b>					
(reference frequency 38,90 MHz)		$\Delta\tau$			
	36,90 MHz	—	-50	—	ns
	34,47 MHz	—	70	—	ns
<b>Impedance at 37,40 MHz</b>					
Input: $Z_{\text{IN}} = R_{\text{IN}} \parallel C_{\text{IN}}$		—	2,5 $\parallel$ 9,5	—	$\text{k}\Omega \parallel \text{pF}$
Output: $Z_{\text{OUT}} = R_{\text{OUT}} \parallel C_{\text{OUT}}$		—	2,9 $\parallel$ 2,6	—	$\text{k}\Omega \parallel \text{pF}$
<b>Temperature coefficient of frequency</b>		$TC_f$	-72	—	ppm/K

**Frequency response**

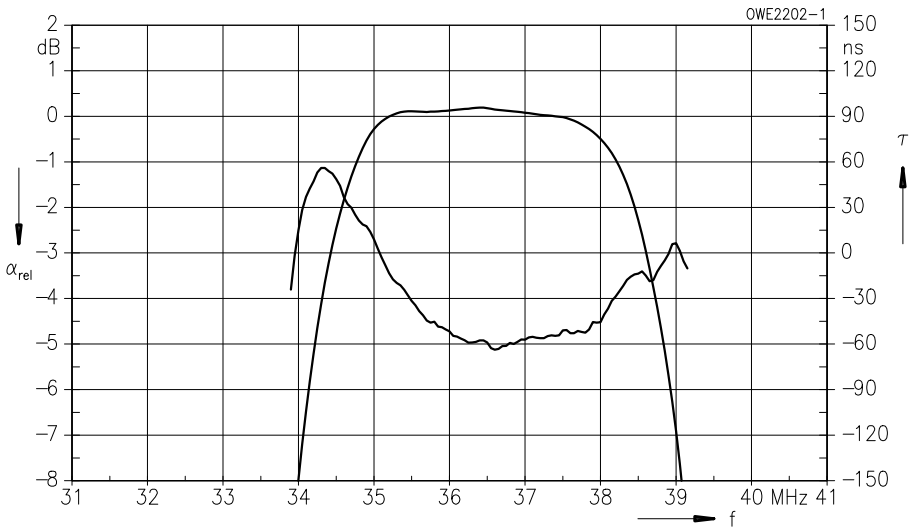
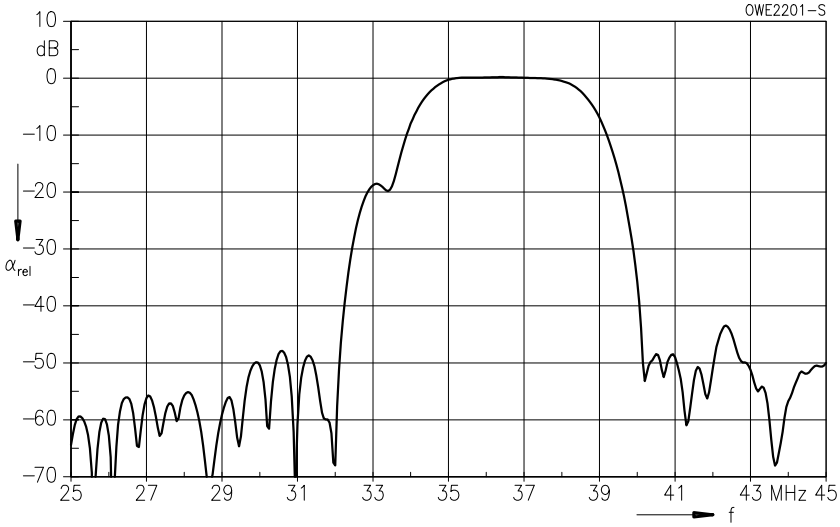

### Standard

- B/G-CCIR  
Germany, Europe partly

### Features

- TV IF filter with Nyquist slope and sound shelf
- Highly reduced group delay predistortion as compared with standard B/G, half
- Suitable for CENELEC EN 55020

### Terminals

- Tinned CuFe alloy

Plastic package **SIP 5 K**

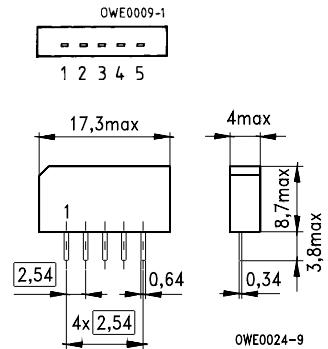

Dimensions in mm, approx. weight 1,0 g

### Pin configuration

- 1 Input
- 2 Input – ground
- 3 Chip carrier – ground
- 4 Output
- 5 Output

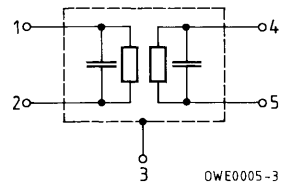

Type	Ordering code	Marking
G 1962 M	B39389-G1962-M100	Type, date code, pin 1

### Maximum ratings

Ambient temperature	$T_A$	- 25/+ 65	°C	—
Storage temperature	$T_{stg}$	- 25/+ 85	°C	—
DC voltage	$V_{DC}$	12	V	between any terminals
AC voltage	$V_{pp}$	10	V	between any terminals

# G 1962 M

## 38,90 MHz

### Characteristics

Ambient temperature	$T_A = 25\text{ °C}$
Source impedance	$Z_S = 50\ \Omega$
Load impedance	$Z_L = 2\text{ k}\Omega \parallel 3\text{ pF}$

		min.	typ.	max.	
<b>Insertion attenuation</b>					
Reference level for the following data	37,40 MHz	13,5	15,1	16,5	dB
<b>Relative attenuation</b>					
Picture carrier	38,90 MHz	4,9	5,9	6,9	dB
Color carrier	34,47 MHz	1,3	2,3	3,3	dB
Sound carrier	33,40 MHz	18,5	19,5	20,5	dB
Adjacent picture carrier	UHF 30,90 MHz	46,0	52,0	—	dB
	VHF 31,90 MHz	48,0	54,0	—	dB
	31,40 MHz	46,0	52,0	—	dB
	32,40 MHz	48,0	56,0	—	dB
	40,15 MHz	42,0	49,0	—	dB
Adjacent sound carrier	VHF 40,40 MHz	46,0	58,0	—	dB
	UHF 41,40 MHz	42,0	52,0	—	dB
Lower sidelobe	25,00 ... 31,40 MHz	42,0	47,0	—	dB
Upper sidelobe	40,40 ... 45,00 MHz	38,0	43,0	—	dB
<b>Reflected wave signal suppression</b>					
1,3 $\mu$ s ... 6,0 $\mu$ s after main pulse (test pulse: 250 ns, carrier frequency: 37,40 MHz)		44,0	54,0	—	dB
<b>Feedthrough signal suppression</b>					
1,3 $\mu$ s ... 1,2 $\mu$ s before main pulse (test pulse: 250 ns, carrier frequency: 37,40 MHz)		50,0	56,0	—	dB
<b>Group delay predistortion</b>					
(reference frequency 38,90 MHz)					
	36,90 MHz	—	- 70	—	ns
	34,47 MHz	—	30	—	ns
<b>Impedance at 37,40 MHz</b>					
Input: $Z_{IN} = R_{IN} \parallel C_{IN}$		—	2,2 $\parallel$ 13,3	—	k $\Omega$ $\parallel$ pF
Output: $Z_{OUT} = R_{OUT} \parallel C_{OUT}$		—	1,4 $\parallel$ 4,7	—	k $\Omega$ $\parallel$ pF
<b>Temperature coefficient of frequency</b>					
$TC_f$		—	- 72	—	ppm/K

Frequency response

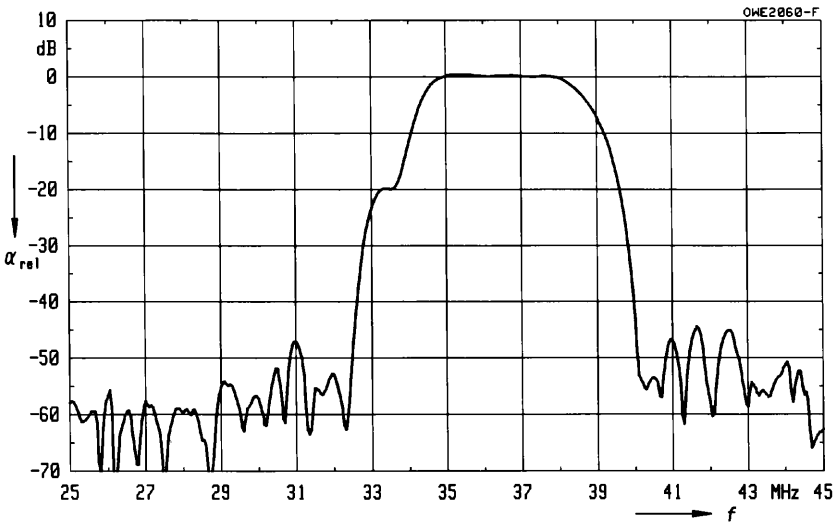
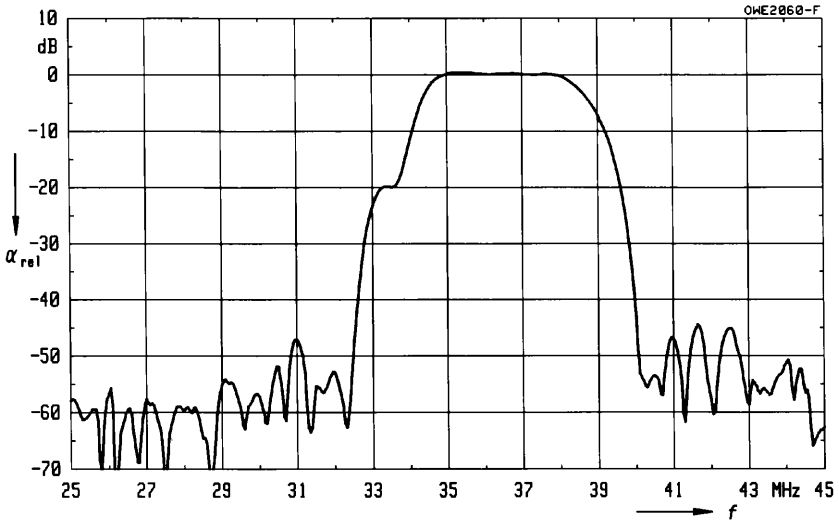

### Standard

- B/G-CCIR  
Germany, Europe partly

### Features

- TV IF filter with Nyquist slope and sound shelf
- High color carrier level
- Constant group delay
- Suitable for CENELEC EN 55020

### Terminals

- Tinned CuFe alloy

Plastic package **SIP 5 K**

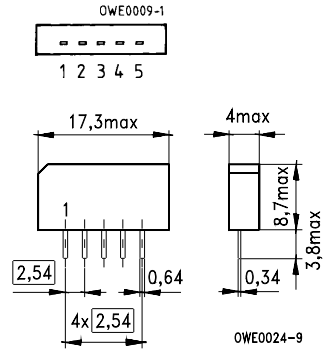

Dimensions in mm, approx. weight 1,0 g

### Pin configuration

- 1 Input
- 2 Input – ground
- 3 Chip carrier – ground
- 4 Output
- 5 Output

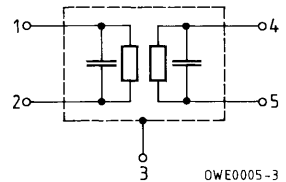

Type	Ordering code	Marking
G 1965 M	B39389-G1965-M100	Type, date code, pin 1

### Maximum ratings

Ambient temperature	$T_A$	- 25/+ 65	°C	—
Storage temperature	$T_{stg}$	- 25/+ 85	°C	—
DC voltage	$V_{DC}$	12	V	between any terminals
AC voltage	$V_{pp}$	10	V	between any terminals



**Characteristics**

Ambient temperature  $T_A = 25\text{ °C}$   
 Source impedance  $Z_S = 50\ \Omega$   
 Load impedance  $Z_L = 2\text{ k}\Omega \parallel 3\text{ pF}$

		min.	typ.	max.		
<b>Insertion attenuation</b>						
Reference level for the following data	37,40 MHz	$\alpha$	13,5	15,0	16,5	dB
<b>Relative attenuation</b>						
Picture carrier	38,90 MHz	$\alpha_{rel}$	5,0	6,0	7,0	dB
Color carrier	34,47 MHz		0,0	1,0	2,0	dB
Sound carrier	33,40 MHz		18,9	20,4	21,9	dB
Adjacent picture carrier	UHF 30,90 MHz		45,0	57,0	—	dB
	VHF 31,90 MHz		48,0	55,0	—	dB
	31,40 MHz		46,0	61,0	—	dB
	32,40 MHz		48,0	55,0	—	dB
	40,15 MHz		38,0	48,0	—	dB
Adjacent sound carrier	VHF 40,40 MHz		44,0	55,0	—	dB
	UHF 41,40 MHz		42,0	53,0	—	dB
Lower sidelobe	25,00 ... 31,90 MHz		40,0	47,0	—	dB
Upper sidelobe	40,40 ... 45,00 MHz		38,0	48,0	—	dB
<b>Reflected wave signal suppression</b>						
1,1 $\mu$ s ... 6,0 $\mu$ s after main pulse (test pulse: 250 ns, carrier frequency: 37,40 MHz)			42,0	53,0	—	dB
<b>Feedthrough signal suppression</b>						
1,3 $\mu$ s ... 1,1 $\mu$ s before main pulse (test pulse: 250 ns, carrier frequency: 37,40 MHz)			50,0	56,0	—	dB
<b>Group delay ripple (p-p)</b>		$\Delta\tau$	—	50	—	ns
<b>Impedance at 37,40 MHz</b>						
Input: $Z_{IN} = R_{IN} \parallel C_{IN}$			—	1,9 $\parallel$ 13,8	—	k $\Omega$ $\parallel$ pF
Output: $Z_{OUT} = R_{OUT} \parallel C_{OUT}$			—	1,5 $\parallel$ 4,8	—	k $\Omega$ $\parallel$ pF
<b>Temperature coefficient of frequency</b>		$TC_f$	—	-72	—	ppm/K

Frequency response

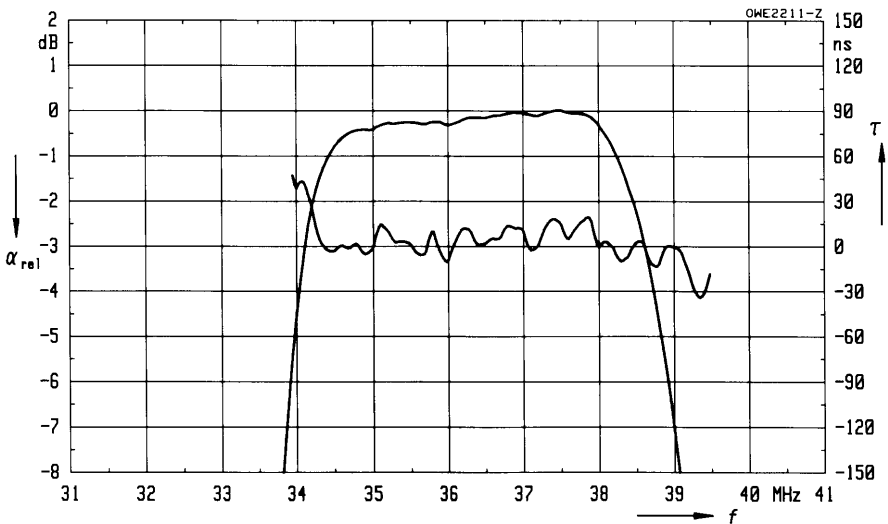
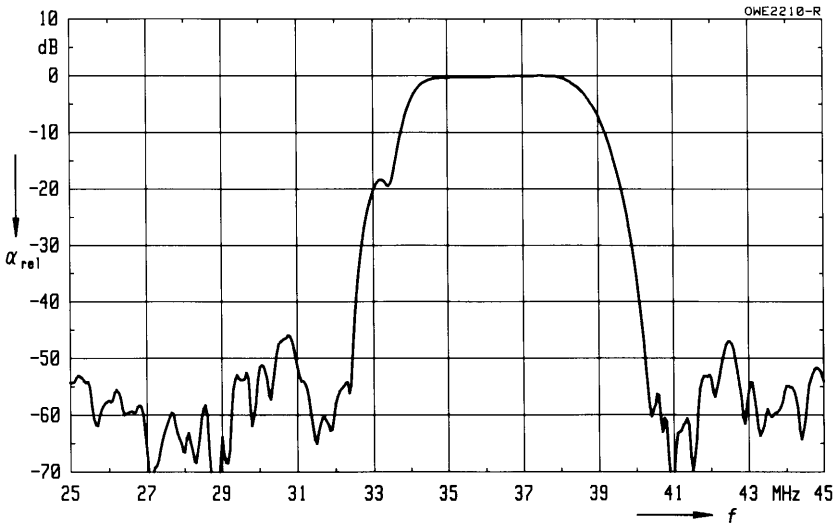

### Standard

- B/G-CCIR  
Germany, Europe partly

### Features

- TV IF filter with Nyquist slope and sound shelf
- Highly reduced group delay predistortion as compared with standard B/G, half
- Optimized for CENELEC EN 55020

### Terminals

- Tinned CuFe alloy

Plastic package **SIP 5 K**

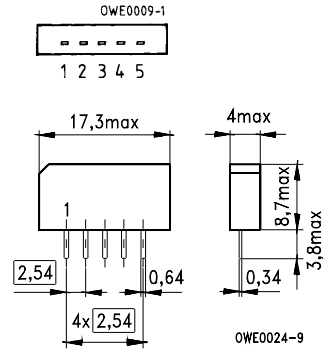

Dimensions in mm, approx. weight 1,0 g

### Pin configuration

- 1 Input
- 2 Input – ground
- 3 Chip carrier – ground
- 4 Output
- 5 Output

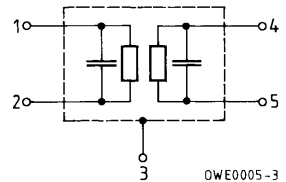

Type	Ordering code	Marking
G 1966 M	B39389-G1966-M100	Type, date code, pin 1

### Maximum ratings

Ambient temperature	$T_A$	- 25/+ 65	°C	—
Storage temperature	$T_{stg}$	- 25/+ 85	°C	—
DC voltage	$V_{DC}$	12	V	between any terminals
AC voltage	$V_{pp}$	10	V	between any terminals

# G 1966 M

## 38,90 MHz

### Characteristics

Ambient temperature  $T_A = 25\text{ °C}$   
 Source impedance  $Z_S = 50\ \Omega$   
 Load impedance  $Z_L = 2\text{ k}\Omega \parallel 3\text{ pF}$

		min.	typ.	max.	
<b>Insertion attenuation</b>					
Reference level for the following data	37,40 MHz	$\alpha$ 13,8	15,3	16,8	dB
<b>Relative attenuation</b>					
Picture carrier	38,90 MHz	$\alpha_{rel}$ 4,2	5,2	6,2	dB
Color carrier	34,47 MHz	1,8	2,8	3,8	dB
Sound carrier	33,40 MHz	17,6	18,6	19,6	dB
Adjacent picture carrier	UHF 30,90 MHz	46,0	60,0	—	dB
	VHF 31,90 MHz	46,0	52,0	—	dB
	32,40 MHz	46,0	56,0	—	dB
	40,15 MHz	46,0	55,0	—	dB
Adjacent sound carrier	VHF 40,40 MHz	38,0	44,0	—	dB
	UHF 41,40 MHz	48,0	58,0	—	dB
Lower sidelobe	25,00 ... 32,40 MHz	45,0	58,0	—	dB
Upper sidelobe	40,40 ... 45,00 MHz	38,0	44,0	—	dB
<b>Reflected wave signal suppression</b>					
1,3 $\mu$ s ... 6,0 $\mu$ s after main pulse (test pulse: 250 ns, carrier frequency: 37,40 MHz)		44,0	52,0	—	dB
<b>Feedthrough signal suppression</b>					
1,1 $\mu$ s ... 1,0 $\mu$ s before main pulse (test pulse: 250 ns, carrier frequency: 37,40 MHz)		50,0	56,0	—	dB
<b>Group delay predistortion</b>					
(reference frequency 38,90 MHz)		$\Delta\tau$			
	36,80 MHz	—	- 50	—	ns
	34,47 MHz	—	60	—	ns
<b>Impedance at 37,40 MHz</b>					
Input:	$Z_{IN} = R_{IN} \parallel C_{IN}$	—	1,1 $\parallel$ 22,9	—	k $\Omega$ $\parallel$ pF
Output:	$Z_{OUT} = R_{OUT} \parallel C_{OUT}$	—	1,3 $\parallel$ 8,5	—	k $\Omega$ $\parallel$ pF
<b>Temperature coefficient of frequency</b>					
	$TC_f$	—	- 72	—	ppm/K

Frequency response

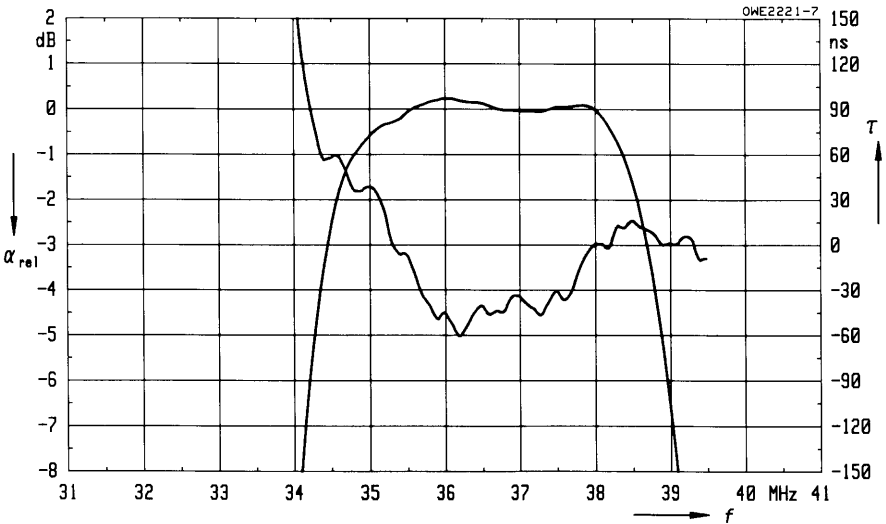
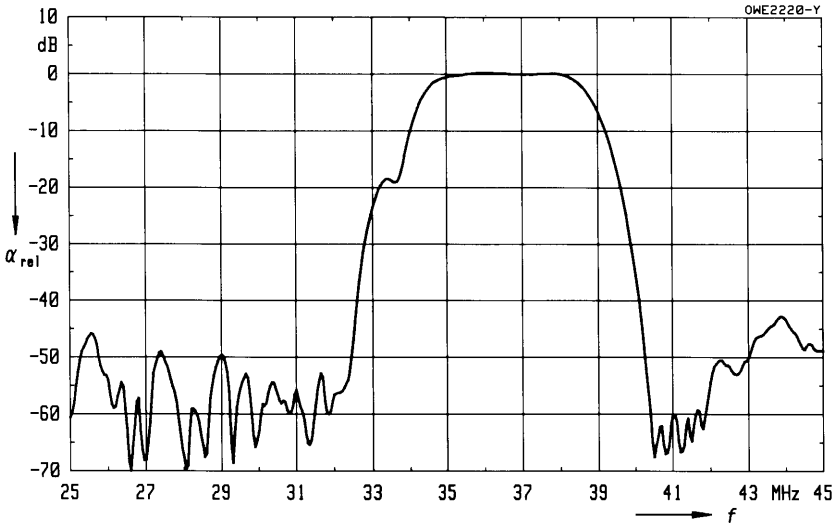

### Standard

- B/G-CCIR  
Germany, Europe partly

### Features

- TV IF filter with Nyquist slope and sound shelf
- Group delay predistortion according standard B/G, half
- Optimized for CENELEC EN 55020

### Terminals

- Tinned CuFe alloy

Plastic package **SIP 5 K**

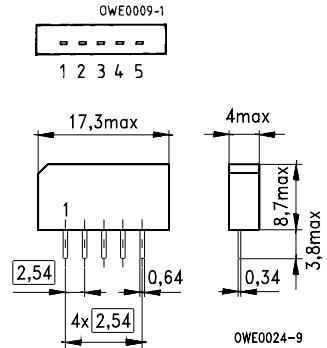

Dimensions in mm, approx. weight 1,0 g

### Pin configuration

- 1 Input
- 2 Input – ground
- 3 Chip carrier – ground
- 4 Output
- 5 Output

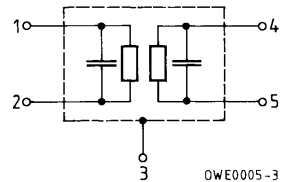

Type	Ordering code	Marking
G 1968 M	B39389-G1968-M100	Type, date code, pin 1

### Maximum ratings

Ambient temperature	$T_A$	- 25/+ 65	°C	—
Storage temperature	$T_{stg}$	- 25/+ 85	°C	—
DC voltage	$V_{DC}$	12	V	between any terminals
AC voltage	$V_{pp}$	10	V	between any terminals

**Characteristics**

Ambient temperature  $T_A = 25\text{ °C}$   
 Source impedance  $Z_S = 50\ \Omega$   
 Load impedance  $Z_L = 2\text{ k}\Omega \parallel 3\text{ pF}$

		min.	typ.	max.		
<b>Insertion attenuation</b>						
Reference level for the following data	37,40 MHz	$\alpha$	13,5	15,1	16,5	dB
<b>Relative attenuation</b>						
Picture carrier	38,90 MHz	$\alpha_{rel}$	4,6	5,6	6,6	dB
Color carrier	34,47 MHz		2,7	3,7	4,7	dB
Sound carrier	33,40 MHz		18,4	19,9	21,4	dB
Adjacent picture carrier	UHF 30,90 MHz		48,0	60,0	—	dB
	VHF 31,90 MHz		48,0	59,0	—	dB
	32,40 MHz		48,0	61,0	—	dB
	40,15 MHz		48,0	58,0	—	dB
Adjacent sound carrier	VHF 40,40 MHz		42,0	51,0	—	dB
	UHF 41,40 MHz		48,0	58,0	—	dB
Lower sidelobe	25,00 ... 32,40 MHz		44,0	55,0	—	dB
Upper sidelobe	40,40 ... 45,00 MHz		40,0	44,0	—	dB
			38,0	47,0	—	dB
<b>Reflected wave signal suppression</b>						
1,2 $\mu$ s ... 6,0 $\mu$ s after main pulse (test pulse: 250 ns, carrier frequency: 37,40 MHz)			44,0	50,0	—	dB
<b>Feedthrough signal suppression</b>						
1,3 $\mu$ s ... 1,1 $\mu$ s before main pulse (test pulse: 250 ns, carrier frequency: 37,40 MHz)			50,0	56,0	—	dB
<b>Group delay predistortion</b>						
(reference frequency 38,90 MHz)		$\Delta\tau$				
	36,90 MHz		—	- 90	—	ns
	34,47 MHz		—	165	—	ns
<b>Impedance at 37,40 MHz</b>						
Input:	$Z_{IN} = R_{IN} \parallel C_{IN}$		—	1,7 $\parallel$ 13,7	—	k $\Omega$ $\parallel$ pF
Output:	$Z_{OUT} = R_{OUT} \parallel C_{OUT}$		—	1,6 $\parallel$ 4,8	—	k $\Omega$ $\parallel$ pF
<b>Temperature coefficient of frequency</b>		$TC_f$	—	- 72	—	ppm/K

Frequency response

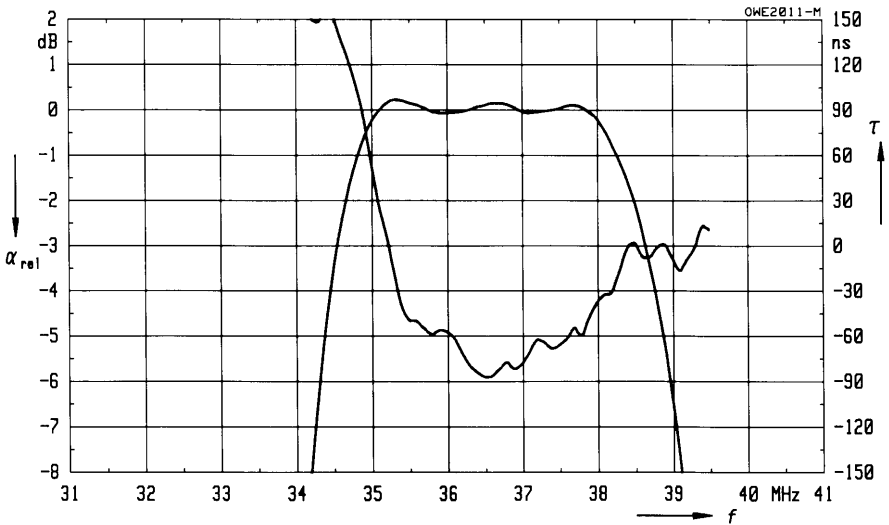
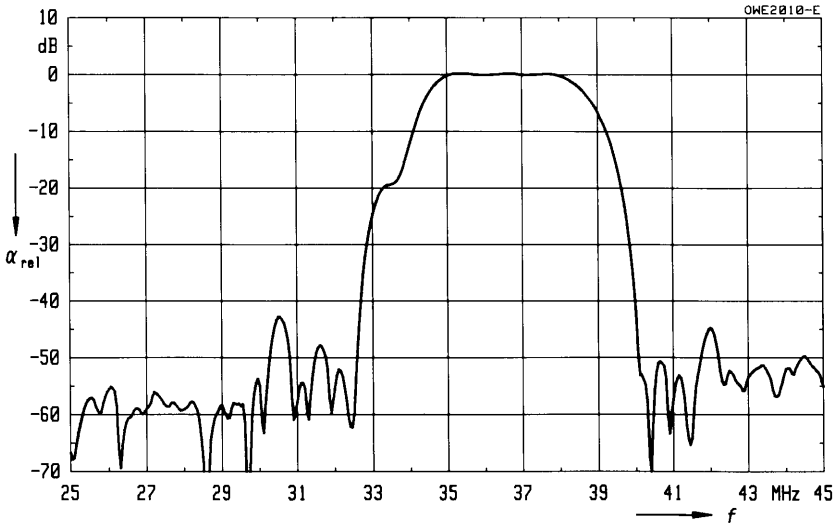



## Standard

- I  
Great Britain

## Features

- TV IF filter with Nyquist slope and sound shelf
- Constant group delay
- Suitable for CENELEC EN 55020

## Terminals

- Tinned CuFe alloy

Plastic package **SIP 5 K**

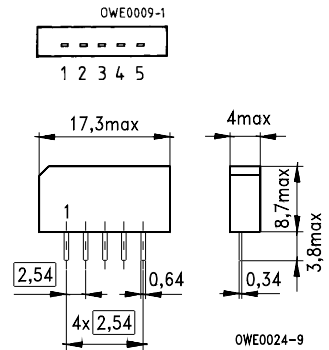

Dimensions in mm, approx. weight 1,0 g

## Pin configuration

- 1 Input
- 2 Input – ground
- 3 Chip carrier – ground
- 4 Output
- 5 Output

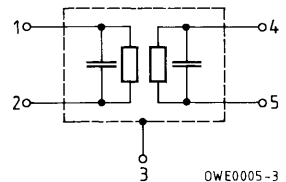

Type	Ordering code	Marking
J 1952 M	B39389-J1952-M100	Type, date code, pin 1

## Maximum ratings

Ambient temperature	$T_A$	- 25/+ 65	°C	—
Storage temperature	$T_{stg}$	- 25/+ 85	°C	—
DC voltage	$V_{DC}$	12	V	between any terminals
AC voltage	$V_{pp}$	10	V	between any terminals

# J 1952 M

## 38,90 MHz

### Characteristics

Ambient temperature  $T_A = 25\text{ °C}$   
 Source impedance  $Z_S = 50\ \Omega$   
 Load impedance  $Z_L = 2\text{ k}\Omega \parallel 3\text{ pF}$

		min.	typ.	max.	
<b>Insertion attenuation</b>					
Reference level for the following data	37,00 MHz	14,0	15,6	17,0	dB
<b>Relative attenuation</b>					
Picture carrier	38,90 MHz	5,5	6,5	7,5	dB
Color carrier	34,47 MHz	1,2	2,2	3,2	dB
Sound carrier	32,90 MHz	19,4	20,4	21,4	dB
Adjacent picture carrier	30,90 MHz	46,0	56,0	—	dB
	30,40 MHz	45,0	56,0	—	dB
	31,40 MHz	42,0	52,0	—	dB
Adjacent sound carrier	40,90 MHz	44,0	53,0	—	dB
Lower sidelobe	25,00 ... 30,90 MHz	42,0	50,0	—	dB
Upper sidelobe	40,90 ... 45,00 MHz	38,0	44,0	—	dB
<b>Reflected wave signal suppression</b>					
1,3 $\mu$ s ... 6,0 $\mu$ s after main pulse (test pulse: 250 ns, carrier frequency: 37,00 MHz)		42,0	50,0	—	dB
<b>Feedthrough signal suppression</b>					
1,1 $\mu$ s ... 0,9 $\mu$ s before main pulse (test pulse: 250 ns, carrier frequency: 37,00 MHz)		50,0	56,0	—	dB
<b>Group delay ripple (p-p)</b>	$\Delta\tau$	—	40	—	ns
<b>Impedance at 37,00 MHz</b>					
Input: $Z_{IN} = R_{IN} \parallel C_{IN}$		—	2,3 $\parallel$ 10,0	—	k $\Omega$ $\parallel$ pF
Output: $Z_{OUT} = R_{OUT} \parallel C_{OUT}$		—	1,9 $\parallel$ 5,2	—	k $\Omega$ $\parallel$ pF
<b>Temperature coefficient of frequency</b>	$TC_f$	—	-72	—	ppm/K

Frequency response

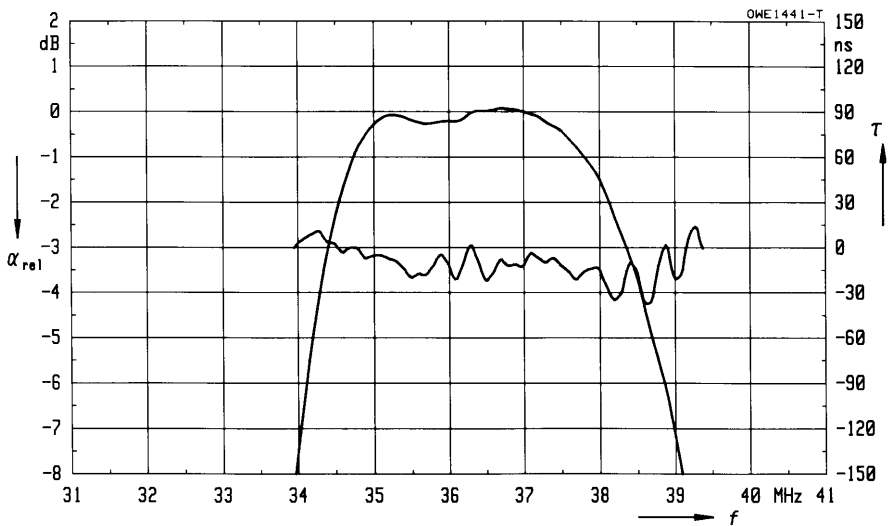
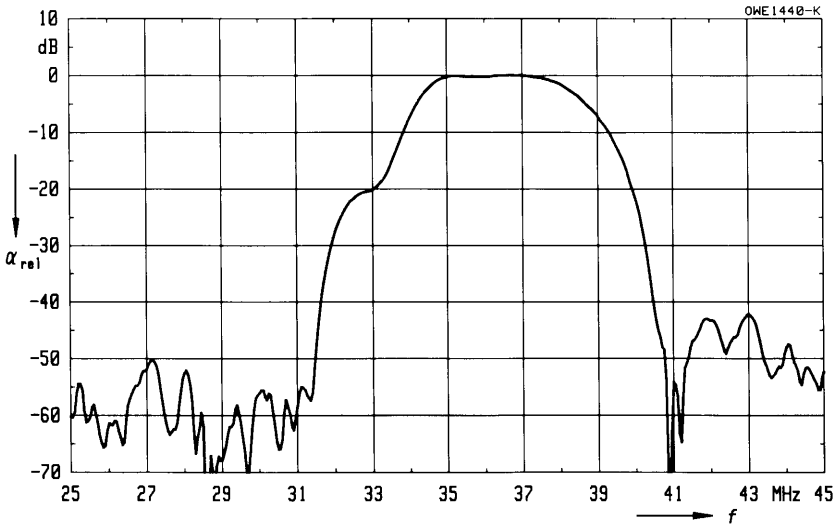

## Standard

- I  
Great Britain

## Features

- TV IF filter with Nyquist slope and sound shelf
- Broad sound shelf at 14 dB level for sound carriers at 32,90 MHz and 32,35 MHz (NICAM)
- Constant group delay
- Suitable for CENELEC EN 55020

## Terminals

- Tinned CuFe alloy

Plastic package **SIP 5 K**

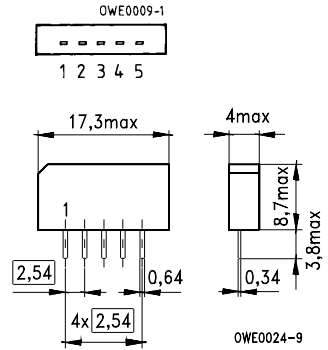

Dimensions in mm, approx. weight 1,0 g

## Pin configuration

- 1 Input
- 2 Input – ground
- 3 Chip carrier – ground
- 4 Output
- 5 Output

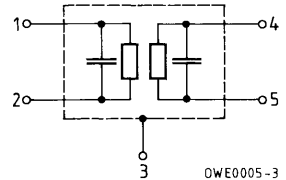

Type	Ordering code	Marking
J 1980 M	B39389-J1980-M100	Type, date code, pin 1

## Maximum ratings

Ambient temperature	$T_A$	- 25/+ 65	°C	—
Storage temperature	$T_{stg}$	- 25/+ 85	°C	—
DC voltage	$V_{DC}$	12	V	between any terminals
AC voltage	$V_{pp}$	10	V	between any terminals

**Characteristics**

Ambient temperature  $T_A = 25\text{ °C}$   
 Source impedance  $Z_S = 50\ \Omega$   
 Load impedance  $Z_L = 2\text{ k}\Omega \parallel 3\text{ pF}$

		min.	typ.	max.	
<b>Insertion attenuation</b>					
Reference level for the following data	37,00 MHz	$\alpha$ 14,0	15,5	17,0	dB
<b>Relative attenuation</b>					
Picture carrier	38,90 MHz	$\alpha_{rel}$ 5,2	6,2	7,2	dB
Color carrier	34,47 MHz	-0,8	0,2	1,2	dB
Sound carrier	32,90 MHz	12,8	13,8	14,8	dB
	32,35 MHz	12,8	13,8	—	dB
Adjacent picture carrier	30,90 MHz	46,0	54,0	—	dB
Adjacent sound carrier	40,90 MHz	44,0	53,0	—	dB
	40,35 MHz	40,0	46,0	—	dB
Lower sidelobe	25,00 ... 30,90 MHz	44,0	52,0	—	dB
Upper sidelobe	40,90 ... 45,00 MHz	40,0	48,0	—	dB
<b>Reflected wave signal suppression</b>					
1,2 $\mu$ s ... 6,0 $\mu$ s after main pulse (test pulse: 250 ns, carrier frequency: 37,00 MHz)		42,0	56,0	—	dB
<b>Feedthrough signal suppression</b>					
1,2 $\mu$ s ... 1,1 $\mu$ s before main pulse (test pulse: 250 ns, carrier frequency: 37,00 MHz)		50,0	56,0	—	dB
<b>Group delay ripple (p-p)</b>		$\Delta\tau$	30	—	ns
<b>Impedance at 37,00 MHz</b>					
Input: $Z_{IN} = R_{IN} \parallel C_{IN}$		—	1,6 $\parallel$ 14,4	—	k $\Omega$ $\parallel$ pF
Output: $Z_{OUT} = R_{OUT} \parallel C_{OUT}$		—	2,0 $\parallel$ 3,8	—	k $\Omega$ $\parallel$ pF
<b>Temperature coefficient of frequency</b>		$TC_f$	-72	—	ppm/K

**Frequency response**

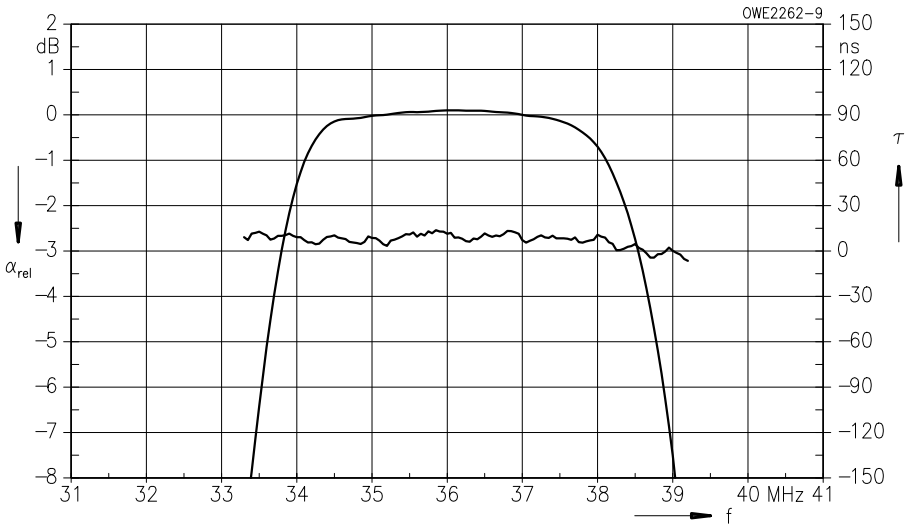
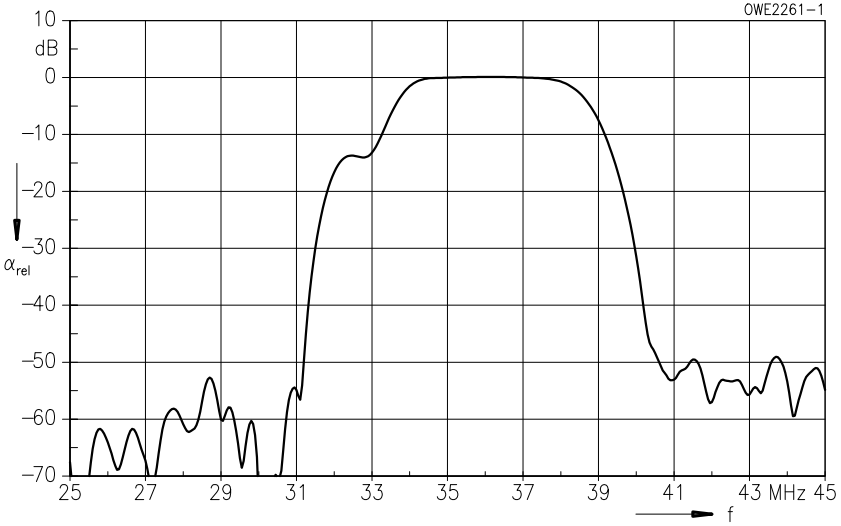

## Standard

- D/K-OIRT  
Eastern standard
- B/G-CCIR  
Europe partly

## Features

- TV IF filter with Nyquist slope and sound shelf
- Broad sound shelf for sound carriers at 32,40 MHz and 33,40 MHz
- Customized group delay predistortion

## Terminals

- Tinned CuFe alloy

Plastic package **SIP 5 K**

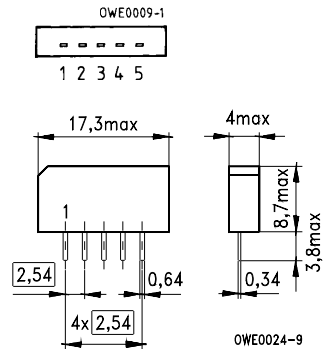

Dimensions in mm, approx. weight 1,0 g

## Pin configuration

- 1 Input
- 2 Input – ground
- 3 Chip carrier – ground
- 4 Output
- 5 Output

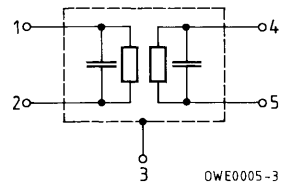

Type	Ordering code	Marking
K 2955 M	B39389-K2955-M100	Type, date code, pin 1

## Maximum ratings

Ambient temperature	$T_A$	- 25/+ 65	°C	—
Storage temperature	$T_{stg}$	- 25/+ 85	°C	—
DC voltage	$V_{DC}$	12	V	between any terminals
AC voltage	$V_{pp}$	10	V	between any terminals

# K 2955 M

## 38,90 MHz

### Characteristics

Ambient temperature	$T_A = 25\text{ °C}$
Source impedance	$Z_S = 50\ \Omega$
Load impedance	$Z_L = 2\text{ k}\Omega \parallel 3\text{ pF}$

		min.	typ.	max.	
<b>Insertion attenuation</b>					
Reference level for the following data	37,40 MHz	16,1	17,6	19,1	dB
<b>Relative attenuation</b>					
Picture carrier	38,90 MHz	4,7	5,7	6,7	dB
Color carrier	34,47 MHz	2,8	3,8	4,8	dB
Sound carrier	32,40 MHz	18,8	20,3	21,8	dB
	33,40 MHz	19,4	20,9	—	dB
Adjacent picture carrier	30,90 MHz	48,0	66,0	—	dB
Adjacent sound carrier	40,40 MHz	43,0	56,0	—	dB
	41,40 MHz	42,0	52,0	—	dB
Lower sidelobe	25,00 ... 30,90 MHz	40,0	51,0	—	dB
Upper sidelobe	40,40 ... 45,00 MHz	36,0	42,0	—	dB
<b>Reflected wave signal suppression</b>					
1,2 $\mu$ s ... 6,0 $\mu$ s after main pulse (test pulse: 250 ns, carrier frequency: 37,40 MHz)		42,0	54,0	—	dB
<b>Feedthrough signal suppression</b>					
1,2 $\mu$ s ... 1,1 $\mu$ s before main pulse (test pulse: 250 ns, carrier frequency: 37,40 MHz)		50,0	56,0	—	dB
<b>Group delay pre-distortion</b>					
(reference frequency 38,90 MHz)					
	36,50 MHz	—	-65	—	ns
	34,47 MHz	—	0	—	ns
<b>Impedance at 37,40 MHz</b>					
Input: $Z_{IN} = R_{IN} \parallel C_{IN}$		—	2,2 $\parallel$ 10,7	—	k $\Omega$ $\parallel$ pF
Output: $Z_{OUT} = R_{OUT} \parallel C_{OUT}$		—	3,1 $\parallel$ 2,8	—	k $\Omega$ $\parallel$ pF
<b>Temperature coefficient of frequency</b>					
	$TC_f$	—	-72	—	ppm/K



**Frequency response**

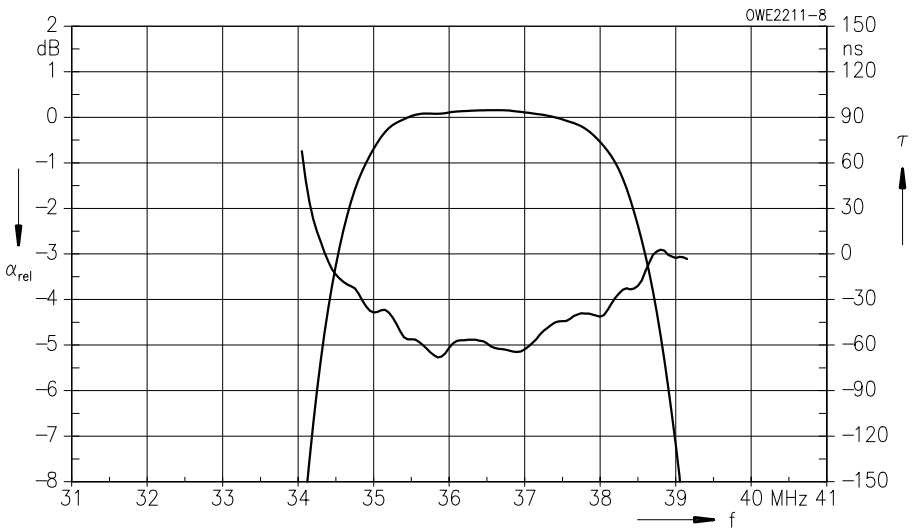
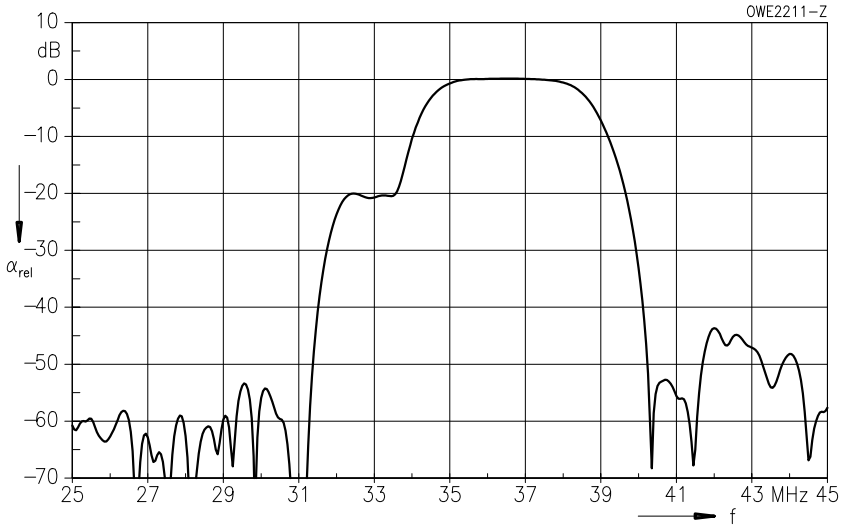

### Standard

- B/G-CCIR  
Germany, Europe partly
- D/K-OIRT  
Eastern standard
- I  
Great Britain
- L/L'  
France

### Features

- TV IF filter with two Nyquist slopes and sound shelf
- Picture carriers at 33,90 MHz and 38,90 MHz
- Broad sound shelf at 15 dB level for sound carriers at 32,90 MHz and 33,40 MHz
- Constant group delay

### Terminals

- Tinned CuFe alloy

### Pin configuration

- 1 Input
- 2 Input – ground
- 3 Chip carrier – ground
- 4 Output
- 5 Output

Plastic package **SIP 5 K**

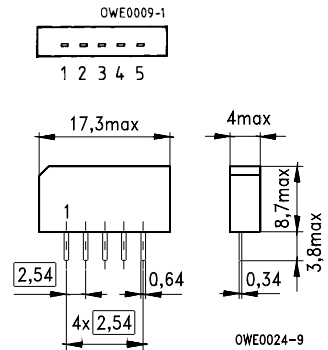

Dimensions in mm, approx. weight 1,0 g

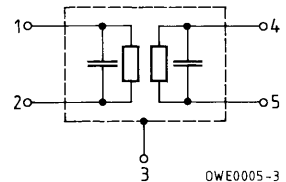

Type	Ordering code	Marking
K 2962 M	B39389-K2962-M100	Type, date code, pin 1

### Maximum ratings

Ambient temperature	$T_A$	- 25/+ 65	°C	—
Storage temperature	$T_{stg}$	- 25/+ 85	°C	—
DC voltage	$V_{DC}$	12	V	between any terminals
AC voltage	$V_{pp}$	10	V	between any terminals

**Characteristics**

Ambient temperature  $T_A = 25\text{ °C}$   
 Source impedance  $Z_S = 50\ \Omega$   
 Load impedance  $Z_L = 2\text{ k}\Omega \parallel 3\text{ pF}$

		min.	typ.	max.	
<b>Insertion attenuation</b>					
Reference level for the following data	37,40 MHz	$\alpha$ 13,4	14,9	16,4	dB
<b>Relative attenuation</b>					
Picture carrier	38,90 MHz	$\alpha_{rel}$ 4,6	5,6	6,6	dB
	33,90 MHz	5,8	6,8	7,8	dB
Color carrier	34,47 MHz	0,0	1,0	2,0	dB
Sound carrier	33,40 MHz	—	14,8	—	dB
	32,90 MHz	—	14,9	—	dB
Adjacent picture carrier	31,90 MHz	44,0	56,0	—	dB
Adjacent sound carrier	40,40 MHz	42,0	50,0	—	dB
Lower sidelobe	25,00 ... 31,90 MHz	40,0	47,0	—	dB
Upper sidelobe	40,40 ... 45,00 MHz	40,0	47,0	—	dB
<b>Reflected wave signal suppression</b>					
1,2 $\mu$ s ... 6,0 $\mu$ s after main pulse (test pulse: 250 ns, carrier frequency: 37,40 MHz)		42,0	54,0	—	dB
<b>Feedthrough signal suppression</b>					
1,2 $\mu$ s ... 1,1 $\mu$ s before main pulse (test pulse: 250 ns, carrier frequency: 37,40 MHz)		50,0	56,0	—	dB
<b>Group delay ripple (p-p)</b>		$\Delta\tau$ —	40	—	ns
<b>Impedance at 37,40 MHz</b>					
Input: $Z_{IN} = R_{IN} \parallel C_{IN}$		—	1,5 $\parallel$ 15,1	—	k $\Omega$ $\parallel$ pF
Output: $Z_{OUT} = R_{OUT} \parallel C_{OUT}$		—	1,8 $\parallel$ 3,9	—	k $\Omega$ $\parallel$ pF
<b>Temperature coefficient of frequency</b>		$TC_f$ —	-72	—	ppm/K

**Frequency response**

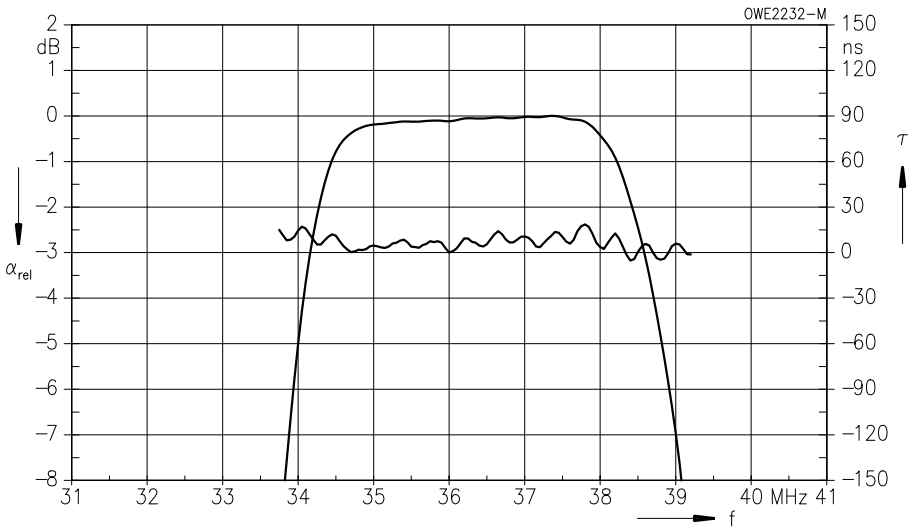
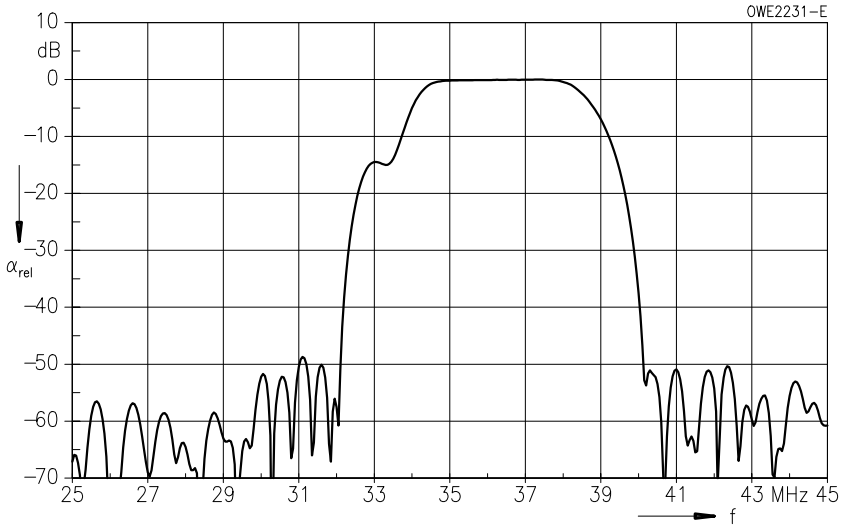

### Standard

- B/G-CCIR  
Germany, Europe partly
- D/K-OIRT  
Eastern standard

Plastic package DIP 10 K

### Features

- TV IF filter switchable from B/G mode to D/K mode
- B/G mode with Nyquist slope and sound shelf at 33,40 MHz
- Highly reduced group delay predistortion as compared with standard B/G half
- D/K mode with Nyquist slope and sound shelf at 32,40 MHz
- Customized group delay predistortion
- Suitable for CENELEC EN 55020

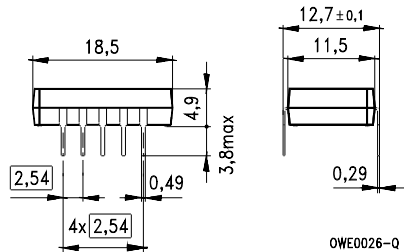
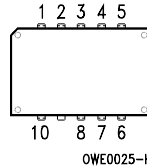

### Terminals

- Tinned CuFe alloy

Dimensions in mm, approx. weight 1,8 g

### Pin configuration

- 1 Input
- 2 Input – ground
- 3, 8 Chip carrier – ground
- 4, 5 Output
- 6, 7 Not connected
- 9 Free
- 10 Switching input

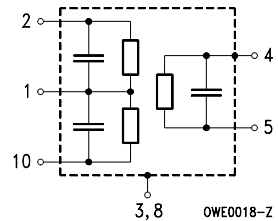

Type	Ordering code	Marking
K 6255 K	B39389-K6255-K100	Type, date code, pin 1

### Maximum ratings

Ambient temperature	$T_A$	- 25/+ 65	°C	—
Storage temperature	$T_{stg}$	- 25/+ 85	°C	—
DC voltage	$V_{DC}$	12	V	between any terminals
AC voltage	$V_{pp}$	10	V	between any terminals

# K 6255 K

## 38,90 MHz

### Characteristics in B/G mode (switching input pin 10 connected to input pin 1)

Ambient temperature  $T_A = 25\text{ }^\circ\text{C}$   
 Source impedance  $Z_S = 50\ \Omega$   
 Load impedance  $Z_L = 2\ \text{k}\Omega \parallel 3\ \text{pF}$

		min.	typ.	max.	
<b>Insertion attenuation</b>					
Reference level for the following data	37,40 MHz	$\alpha$ 15,5	16,9	18,5	dB
<b>Relative attenuation</b>					
Picture carrier	38,90 MHz	$\alpha_{\text{rel}}$ 4,0	5,0	6,0	dB
Color carrier	34,47 MHz	2,1	3,1	4,1	dB
Sound carrier	33,40 MHz	17,8	19,3	20,8	dB
Adjacent picture carrier	UHF 30,90 MHz	44,0	50,0	—	dB
	VHF 31,90 MHz	44,0	50,0	—	dB
Adjacent sound carrier	40,15 MHz	44,0	50,0	—	dB
	VHF 40,40 MHz	37,0	42,0	—	dB
	UHF 41,40 MHz	45,0	56,0	—	dB
Lower sidelobe	25,00 ... 31,90 MHz	42,0	52,0	—	dB
Upper sidelobe	40,40 ... 45,00 MHz	38,0	45,0	—	dB
<b>Reflected wave signal suppression</b>					
1,2 $\mu\text{s}$ ... 6,0 $\mu\text{s}$ after main pulse (test pulse: 250 ns, carrier frequency: 37,40 MHz)		43,0	50,0	—	dB
<b>Feedthrough signal suppression</b>					
1,2 $\mu\text{s}$ ... 1,1 $\mu\text{s}$ before main pulse (test pulse: 250 ns, carrier frequency: 37,40 MHz)		—	56,0	—	dB
<b>Group delay predistortion</b>					
(reference frequency 38,90 MHz)		$\Delta\tau$			
	36,60 MHz	—	- 60	—	ns
	34,47 MHz	—	20	—	ns
<b>Impedance at 37,40 MHz</b>					
Input: $Z_{\text{IN}} = R_{\text{IN}} \parallel C_{\text{IN}}$		—	1,1 $\parallel$ 17,4	—	$\text{k}\Omega \parallel \text{pF}$
Output: $Z_{\text{OUT}} = R_{\text{OUT}} \parallel C_{\text{OUT}}$		—	1,4 $\parallel$ 5,8	—	$\text{k}\Omega \parallel \text{pF}$
<b>Temperature coefficient of frequency</b>					
		$TC_f$	—	- 72	ppm/K

Frequency response (B/G mode)

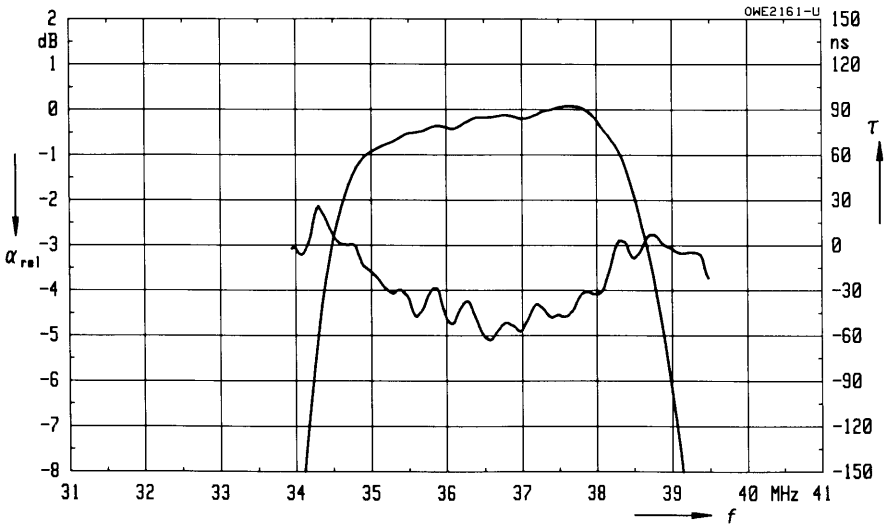
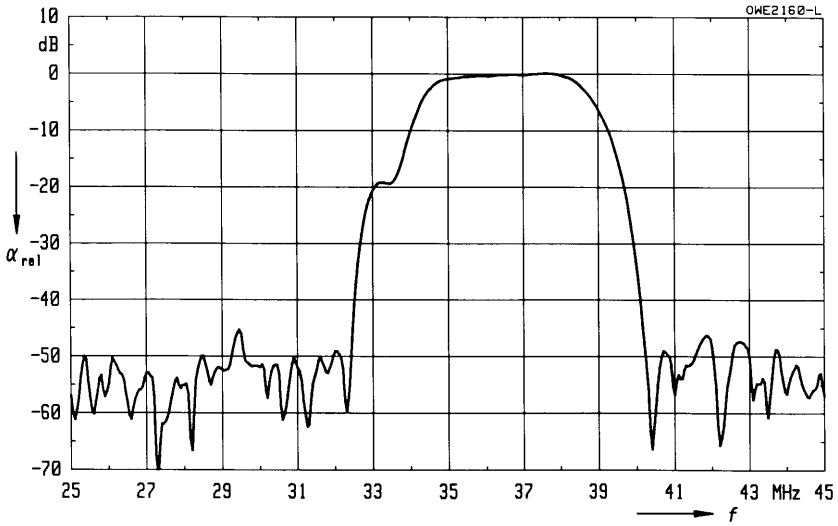

# K 6255 K

## 38,90 MHz

### Characteristics in D/K mode (switching input pin 10 connected to ground input pin 2)

Ambient temperature  $T_A = 25\text{ °C}$   
 Source impedance  $Z_S = 50\ \Omega$   
 Load impedance  $Z_L = 2\text{ k}\Omega \parallel 3\text{ pF}$

		min.	typ.	max.	
<b>Insertion attenuation</b>					
Reference level for the following data	37,40 MHz	15,5	16,8	18,5	dB
<b>Relative attenuation</b>					
Picture carrier	38,90 MHz	4,1	5,1	6,1	dB
Color carrier	34,47 MHz	-0,2	0,8	1,8	dB
Sound carrier	32,40 MHz	18,7	20,2	21,7	dB
Adjacent picture carrier	30,90 MHz	44,0	53,0	—	dB
Adjacent sound carrier	40,40 MHz	44,0	56,0	—	dB
Lower sidelobe	25,00 ... 30,90 MHz	38,0	47,0	—	dB
Upper sidelobe	40,40 ... 45,00 MHz	36,0	43,0	—	dB
<b>Reflected wave signal suppression</b>					
1,2 $\mu$ s ... 6,0 $\mu$ s after main pulse (test pulse: 250 ns, carrier frequency: 37,40 MHz)		43,0	50,0	—	dB
<b>Feedthrough signal suppression</b>					
1,2 $\mu$ s ... 1,1 $\mu$ s before main pulse (test pulse: 250 ns, carrier frequency: 37,40 MHz)		—	56,0	—	dB
<b>Group delay predistortion</b>					
(reference frequency 38,90 MHz)					
	36,60 MHz	—	-50	—	ns
	34,47 MHz	—	20	—	ns
<b>Impedance at 37,40 MHz</b>					
Input: $Z_{IN} = R_{IN} \parallel C_{IN}$		—	0,9 $\parallel$ 23,8	—	k $\Omega$ $\parallel$ pF
Output: $Z_{OUT} = R_{OUT} \parallel C_{OUT}$		—	1,4 $\parallel$ 5,8	—	k $\Omega$ $\parallel$ pF
<b>Temperature coefficient of frequency</b>					
	$TC_f$	—	-72	—	ppm/K



Frequency response (D/K mode)

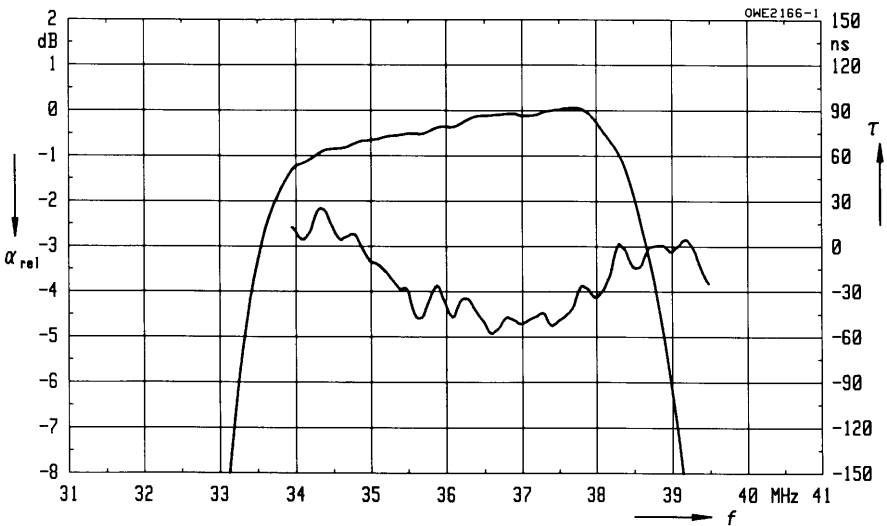
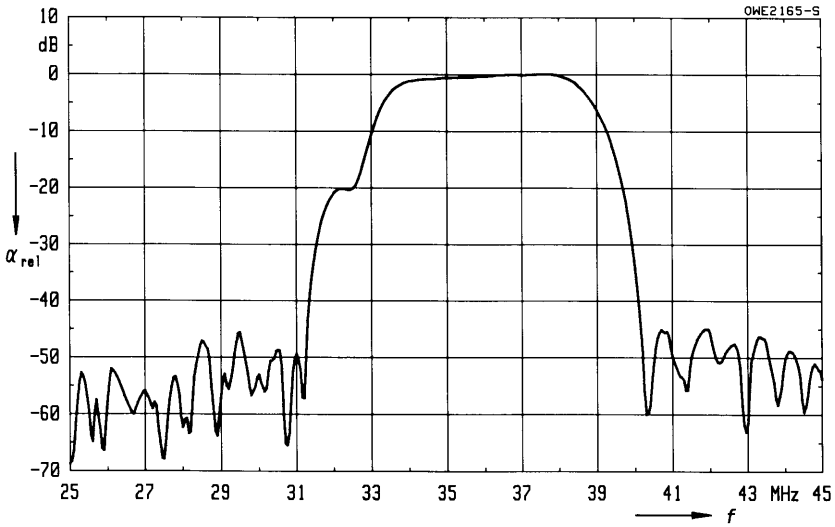

**Standard**

- B/G-CCIR  
Germany, Europe partly
- D/K-OIRT  
Eastern standard
- I  
Great Britain
- L/L'  
France

Plastic package **DIP 10 K**

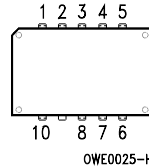

**Features**

- TV IF filter switchable from B/G mode to L/L' mode
- B/G mode with Nyquist slope and sound shelf at 33,40 MHz
- Reduced group delay predistortion as compared with standard B/G half
- L/L' mode with Nyquist slopes at 38,90 MHz and 33,90 MHz
- Constant group delay
- Suitable for CENELEC EN 55020

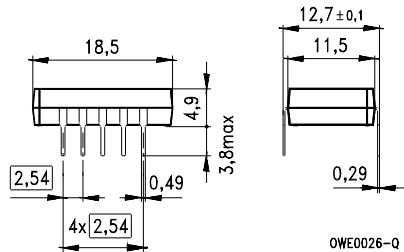

Dimensions in mm, approx. weight 1,8 g

**Terminals**

- Tinned CuFe alloy

**Pin configuration**

- 1 Input
- 2 Input – ground
- 3, 8 Chip carrier – ground
- 4, 5 Output
- 6, 7 Not connected
- 9 Free
- 10 Switching input

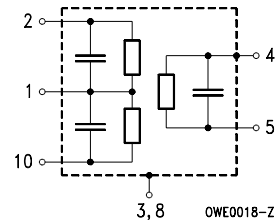

Type	Ordering code	Marking
K 6256 K	B39389-K6256-K100	Type, date code, pin 1

**Maximum ratings**

Ambient temperature	$T_A$	- 25/+ 65	°C	—
Storage temperature	$T_{stg}$	- 25/+ 85	°C	—
DC voltage	$V_{DC}$	12	V	between any terminals
AC voltage	$V_{pp}$	10	V	between any terminals

**Characteristics in B/G mode (switching input pin 10 connected to ground input pin 2)**

Ambient temperature  $T_A = 25\text{ }^\circ\text{C}$   
 Source impedance  $Z_S = 50\text{ }\Omega$   
 Load impedance  $Z_L = 2\text{ k}\Omega \parallel 3\text{ pF}$

		min.	typ.	max.		
<b>Insertion attenuation</b>						
Reference level for the following data	37,40 MHz	$\alpha$	15,5	17,0	18,5	dB
<b>Relative attenuation</b>						
Picture carrier	38,90 MHz	$\alpha_{rel}$	4,5	5,5	6,5	dB
Color carrier	34,47 MHz		1,3	2,3	3,3	dB
Sound carrier	33,40 MHz		18,7	19,7	20,7	dB
Adjacent picture carrier	UHF 30,90 MHz		42,0	49,0	—	dB
	VHF 31,90 MHz		44,0	51,0	—	dB
	32,40 MHz		44,0	52,0	—	dB
	40,15 MHz		38,0	44,0	—	dB
Adjacent sound carrier	VHF 40,40 MHz		44,0	56,0	—	dB
Adjacent picture carrier	UHF 41,40 MHz		42,0	53,0	—	dB
Lower sidelobe	25,00 ... 31,90 MHz		40,0	46,0	—	dB
Upper sidelobe	40,40 ... 45,00 MHz		40,0	47,0	—	dB
<b>Reflected wave signal suppression</b>						
1,2 $\mu\text{s}$ ... 6,0 $\mu\text{s}$ after main pulse (test pulse: 250 ns, carrier frequency: 37,40 MHz)			42,0	50,0	—	dB
<b>Feedthrough signal suppression</b>						
1,2 $\mu\text{s}$ ... 1,1 $\mu\text{s}$ before main pulse (test pulse: 250 ns, carrier frequency: 37,40 MHz)			—	56,0	—	dB
<b>Group delay predistortion</b>						
(reference frequency 38,90 MHz)		$\Delta\tau$				
	36,80 MHz		—	- 65	—	ns
	34,47 MHz		—	30	—	ns
<b>Impedance at 37,40 MHz</b>						
Input: $Z_{IN} = R_{IN} \parallel C_{IN}$			—	1,0 $\parallel$ 23,2	—	k $\Omega$ $\parallel$ pF
Output: $Z_{OUT} = R_{OUT} \parallel C_{OUT}$			—	0,9 $\parallel$ 6,5	—	k $\Omega$ $\parallel$ pF
<b>Temperature coefficient of frequency</b>		$TC_f$	—	- 72	—	ppm/K

Frequency response (B/G mode)

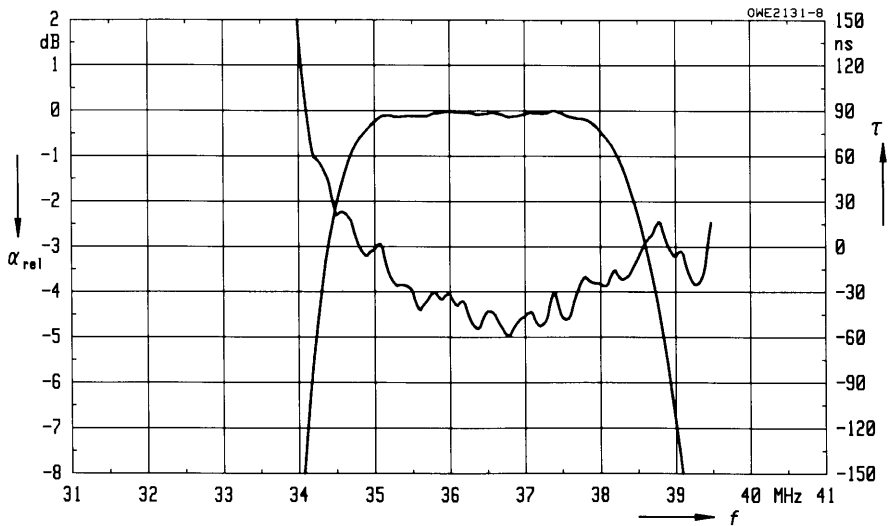
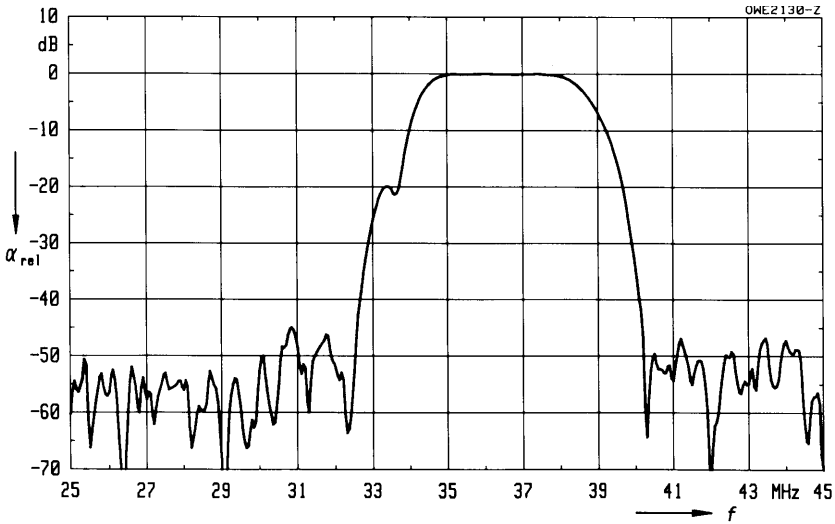

**Characteristics in L/L' mode (switching input pin 10 connected to input pin 1)**

Ambient temperature  $T_A = 25\text{ °C}$   
 Source impedance  $Z_S = 50\ \Omega$   
 Load impedance  $Z_L = 2\text{ k}\Omega \parallel 3\text{ pF}$

		min.	typ.	max.	
<b>Insertion attenuation</b>					
Reference level for the following data	37,40 MHz	$\alpha$ 15,5	17,0	18,5	dB
<b>Relative attenuation</b>					
Picture carrier	38,90 MHz	$\alpha_{rel}$ 4,3	5,3	6,3	dB
	33,90 MHz	5,5	6,5	7,5	dB
	34,47 MHz	-0,2	0,8	1,8	dB
	30,90 MHz	42,0	47,0	—	dB
	32,40 MHz	46,0	53,0	—	dB
	32,90 MHz	—	56,0	—	dB
	40,40 MHz	42,0	53,0	—	dB
	40,90 MHz	—	49,0	—	dB
	41,90 MHz	43,0	54,0	—	dB
Lower sidelobe	25,00 ... 32,90 MHz	40,0	46,0	—	dB
Upper sidelobe	40,40 ... 45,00 MHz	40,0	46,0	—	dB
<b>Reflected wave signal suppression</b>					
1,2 $\mu$ s ... 6,0 $\mu$ s after main pulse (test pulse: 250 ns, carrier frequency: 37,40 MHz)		42,0	52,0	—	dB
<b>Feedthrough signal suppression</b>					
1,2 $\mu$ s ... 1,1 $\mu$ s before main pulse (test pulse: 250 ns, carrier frequency: 37,40 MHz)		—	56,0	—	dB
<b>Group delay ripple (p-p)</b>		$\Delta\tau$	40	—	ns
<b>Impedance at 37,40 MHz</b>					
Input: $Z_{IN} = R_{IN} \parallel C_{IN}$		—	1,6 $\parallel$ 16,1	—	k $\Omega$ $\parallel$ pF
Output: $Z_{OUT} = R_{OUT} \parallel C_{OUT}$		—	0,9 $\parallel$ 6,5	—	k $\Omega$ $\parallel$ pF
<b>Temperature coefficient of frequency</b>		$TC_f$	-72	—	ppm/K

K 6256 K  
33,90/38,90 MHz

Frequency response (L/L' mode)

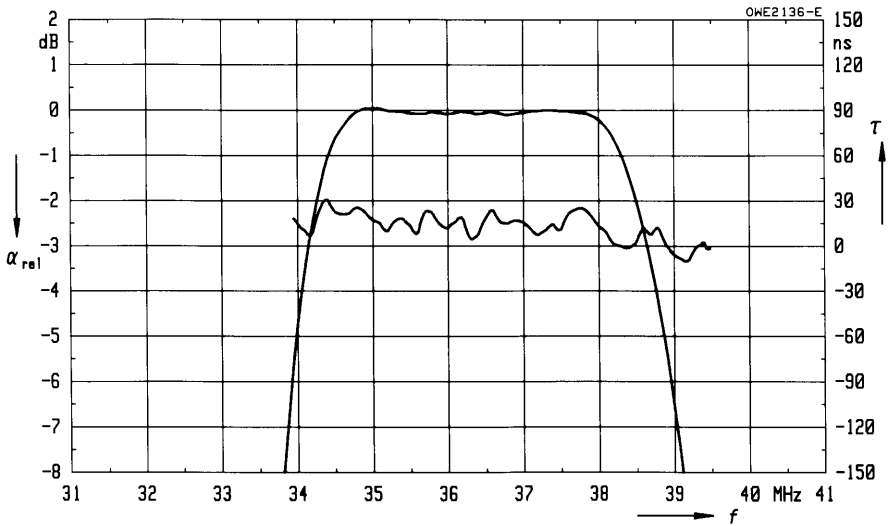
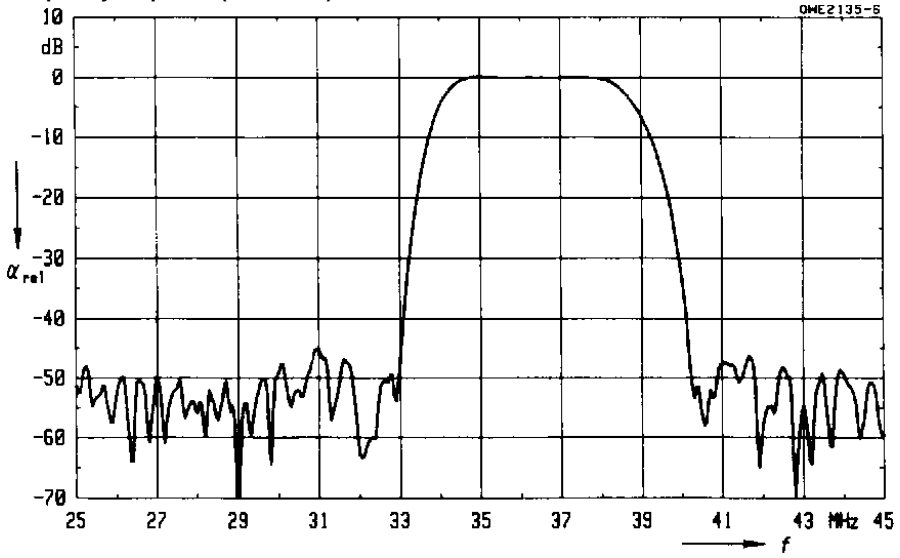

### Standard

- I  
Great Britain

### Features

- TV IF filter with Nyquist slope and sound shelf
- Constant group delay
- Suitable for CENELEC EN 55020

### Terminals

- Tinned CuFe alloy

Plastic package **SIP 5 K**

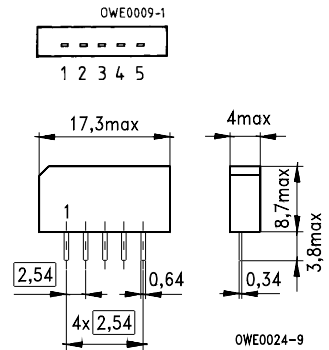

Dimensions in mm, approx. weight 1,0 g

### Pin configuration

- 1 Input
- 2 Input – ground
- 3 Chip carrier – ground
- 4 Output
- 5 Output

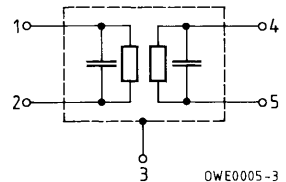

Type	Ordering code	Marking
J 1951 M	B39395-J1951-M100	Type, date code, pin 1

### Maximum ratings

Ambient temperature	$T_A$	- 25/+ 65	°C	—
Storage temperature	$T_{stg}$	- 25/+ 85	°C	—
DC voltage	$V_{DC}$	12	V	between any terminals
AC voltage	$V_{pp}$	10	V	between any terminals

# J 1951 M

## 39,50 MHz

### Characteristics

Ambient temperature	$T_A = 25\text{ °C}$
Source impedance	$Z_S = 50\ \Omega$
Load impedance	$Z_L = 2\text{ k}\Omega \parallel 3\text{ pF}$

		min.	typ.	max.	
<b>Insertion attenuation</b>					
Reference level for the following data	38,00 MHz	14,0	15,3	17,0	dB
<b>Relative attenuation</b>					
Picture carrier	39,50 MHz	4,8	5,8	6,8	dB
Color carrier	35,07 MHz	2,8	3,8	4,8	dB
Sound carrier	33,50 MHz	21,1	22,1	23,1	dB
Adjacent picture carrier	31,50 MHz	48,0	60,0	—	dB
	31,00 MHz	45,0	52,0	—	dB
	32,00 MHz	45,0	52,0	—	dB
	40,95 MHz	36,0	42,0	—	dB
Adjacent sound carrier	41,50 MHz	44,0	54,0	—	dB
Lower sidelobe	25,00 ... 31,50 MHz	44,0	50,0	—	dB
Upper sidelobe	41,50 ... 45,00 MHz	36,0	40,0	—	dB
<b>Reflected wave signal suppression</b>					
1,0 $\mu$ s ... 6,0 $\mu$ s after main pulse (test pulse: 250 ns, carrier frequency: 38,00 MHz)		44,0	52,0	—	dB
<b>Feedthrough signal suppression</b>					
0,9 $\mu$ s ... 0,8 $\mu$ s before main pulse (test pulse: 250 ns, carrier frequency: 38,00 MHz)		50,0	56,0	—	dB
<b>Group delay ripple (p-p)</b>	$\Delta\tau$	—	40	—	ns
<b>Impedance at 38,00 MHz</b>					
Input:	$Z_{IN} = R_{IN} \parallel C_{IN}$	—	2,0 $\parallel$ 10,0	—	k $\Omega$ $\parallel$ pF
Output:	$Z_{OUT} = R_{OUT} \parallel C_{OUT}$	—	2,2 $\parallel$ 4,5	—	k $\Omega$ $\parallel$ pF
<b>Temperature coefficient of frequency</b>	$TC_f$	—	- 72	—	ppm/K



Frequency response

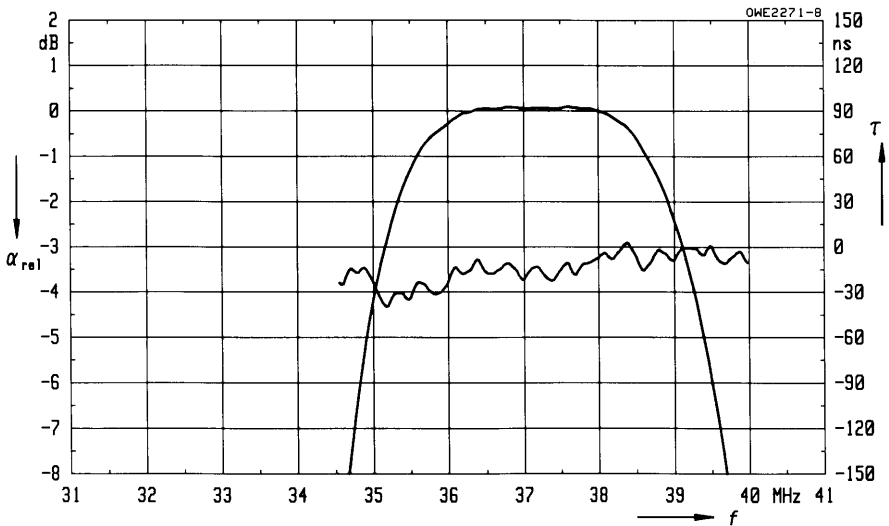
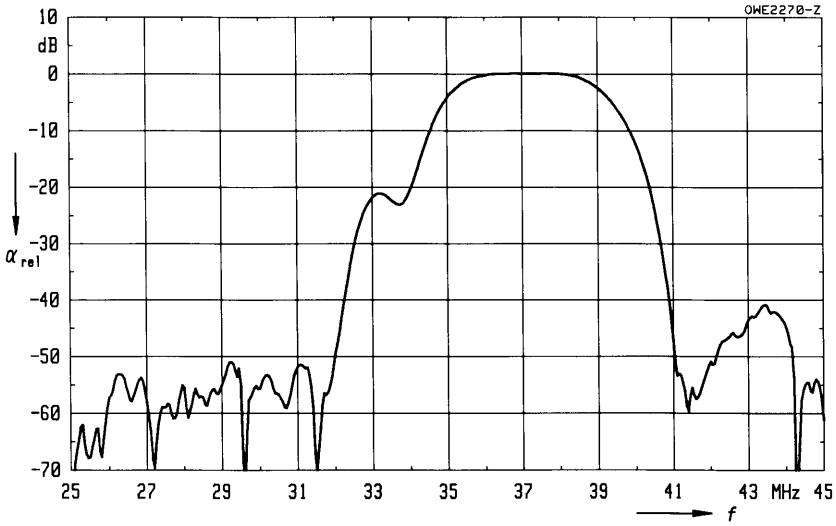

### Standard

- M/N-FCC  
USA

### Features

- TV IF filter with Nyquist slope and sound shelf
- Constant group delay

### Terminals

- Tinned CuFe alloy

Plastic package **SIP 5 K**

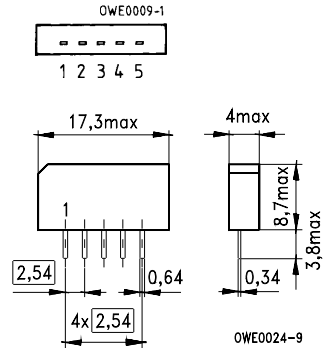

Dimensions in mm, approx. weight 1,0 g

### Pin configuration

- 1 Input
- 2 Input – ground
- 3 Chip carrier – ground
- 4 Output
- 5 Output

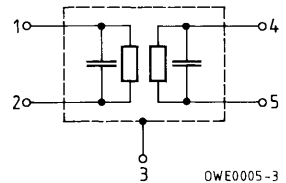

Type	Ordering code	Marking
M 1859 M	B39458-M1859-M100	Type, date code, pin 1

### Maximum ratings

Ambient temperature	$T_A$	- 25/+ 65	°C	—
Storage temperature	$T_{stg}$	- 25/+ 85	°C	—
DC voltage	$V_{DC}$	12	V	between any terminals
AC voltage	$V_{pp}$	10	V	between any terminals

**Characteristics**

Ambient temperature  $T_A = 25 (45) \text{ }^\circ\text{C}$   
 Source impedance  $Z_S = 50 \text{ } \Omega$   
 Load impedance  $Z_L = 2 \text{ k}\Omega \parallel 3 \text{ pF}$

		min.	typ.	max.	
<b>Insertion attenuation</b>	$\alpha$				
Reference level for the following data	44,06 (44,00) MHz	11,7	13,2	14,7	dB
<b>Relative attenuation</b>	$\alpha_{rel}$				
Picture carrier	45,81 (45,75) MHz	4,8	5,8	6,8	dB
Color carrier	42,23 (42,17) MHz	3,5	4,5	5,5	dB
Sound carrier	41,31 (41,25) MHz	15,6	17,1	18,6	dB
Adjacent picture carrier	39,81 (39,75) MHz	44,0	59,0	—	dB
Adjacent sound carrier	47,31 (47,25) MHz	40,0	52,0	—	dB
Lower sidelobe					
	35,06 ... 39,81 (35,00 ... 39,75) MHz	38,0	44,0	—	dB
Upper sidelobe					
	47,31 ... 55,06 (47,25 ... 55,00) MHz	36,0	42,0	—	dB
<b>Reflected wave signal suppression</b>					
1,1 $\mu\text{s}$ ... 6,0 $\mu\text{s}$ after main pulse (test pulse: 250 ns, carrier frequency: 44,06 MHz)		40,0	46,0	—	dB
<b>Feedthrough signal suppression</b>					
0,9 $\mu\text{s}$ ... 0,8 $\mu\text{s}$ before main pulse (test pulse: 250 ns, carrier frequency: 44,06 MHz)		50,0	56,0	—	dB
<b>Group delay ripple (p-p)</b>	$\Delta\tau$	—	40	—	ns
<b>Impedance at 44,06 MHz</b>					
Input: $Z_{IN} = R_{IN} \parallel C_{IN}$		—	1,5 $\parallel$ 9,5	—	k $\Omega$ $\parallel$ pF
Output: $Z_{OUT} = R_{OUT} \parallel C_{OUT}$		—	1,3 $\parallel$ 3,3	—	k $\Omega$ $\parallel$ pF
<b>Temperature coefficient of frequency</b>	$TC_f$	—	-72	—	ppm/K

**M 1859 M**  
**45,75 MHz**

**Frequency response**

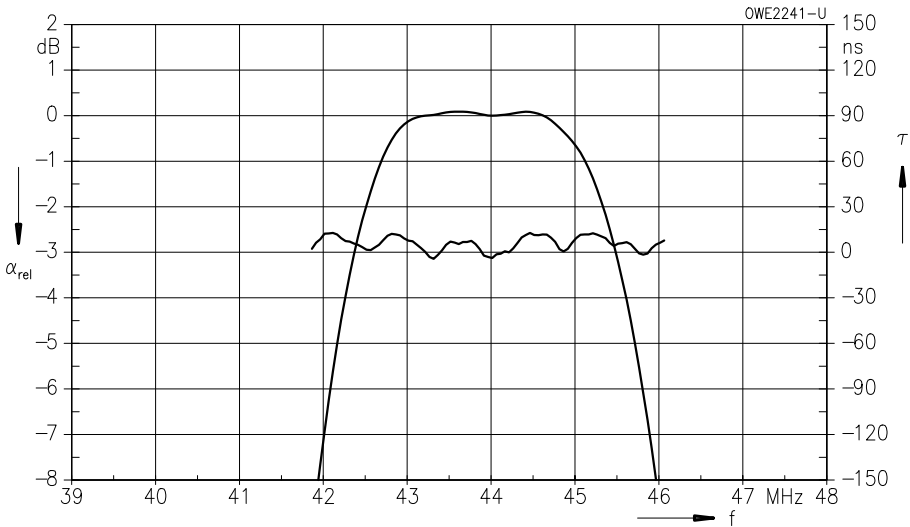
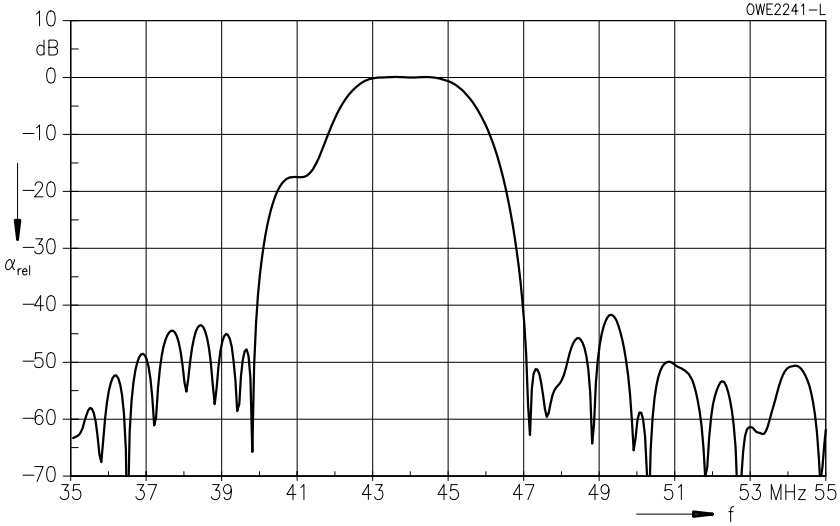

### Standard

- M/N-FCC  
USA

### Features

- TV IF filter with Nyquist slope and sound shelf
- Constant group delay
- Suitable for FCC EIA/IS-31 regulations

### Terminals

- Tinned CuFe alloy

Plastic package **SIP 5 K**

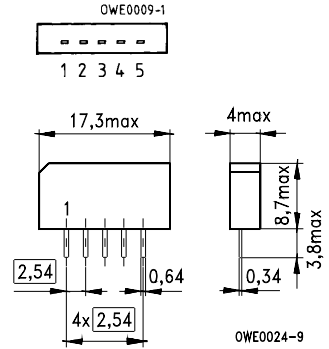

Dimensions in mm, approx. weight 1,0 g

### Pin configuration

- 1 Input
- 2 Input – ground
- 3 Chip carrier – ground
- 4 Output
- 5 Output

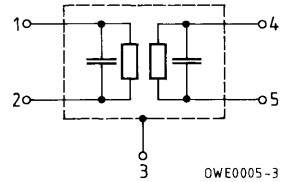

Type	Ordering code	Marking
M 1962 M	B39458-M1962-M100	Type, date code, pin 1

### Maximum ratings

Ambient temperature	$T_A$	- 25/+ 65	°C	—
Storage temperature	$T_{stg}$	- 25/+ 85	°C	—
DC voltage	$V_{DC}$	12	V	between any terminals
AC voltage	$V_{pp}$	10	V	between any terminals

# M 1962 M

## 45,75 MHz

### Characteristics

Ambient temperature	$T_A = 25\text{ °C}$
Source impedance	$Z_S = 50\ \Omega$
Load impedance	$Z_L = 2\text{ k}\Omega \parallel 3\text{ pF}$

		min.	typ.	max.		
<b>Insertion attenuation</b>						
Reference level for the following data	44,00 MHz	$\alpha$	10,0	11,4	13,0	dB
<b>Relative attenuation</b>						
Picture carrier	45,75 MHz	$\alpha_{rel}$	4,1	5,1	6,1	dB
Color carrier	42,17 MHz		4,2	5,2	6,2	dB
Sound carrier	41,25 MHz		18,7	19,7	20,7	dB
Adjacent picture carrier	39,75 MHz		50,0	62,0	—	dB
Adjacent sound carrier	47,25 MHz		50,0	61,0	—	dB
Lower sidelobe	35,00 ... 39,75 MHz		44,0	49,0	—	dB
Upper sidelobe	47,25 ... 55,00 MHz		42,0	47,0	—	dB
<b>Reflected wave signal suppression</b>						
1,0 $\mu$ s ... 6,0 $\mu$ s after main pulse (test pulse: 250 ns, carrier frequency: 44,00 MHz)			44,0	50,0	—	dB
<b>Feedthrough signal suppression</b>						
1,1 $\mu$ s ... 0,9 $\mu$ s before main pulse (test pulse: 250 ns, carrier frequency: 44,00 MHz)			50,0	56,0	—	dB
<b>Group delay ripple (p-p)</b>		$\Delta\tau$	—	40	—	ns
<b>Impedance at 44,00 MHz</b>						
Input: $Z_{IN} = R_{IN} \parallel C_{IN}$			—	1,0 $\parallel$ 12,5	—	k $\Omega$ $\parallel$ pF
Output: $Z_{OUT} = R_{OUT} \parallel C_{OUT}$			—	0,7 $\parallel$ 5,1	—	k $\Omega$ $\parallel$ pF
<b>Temperature coefficient of frequency</b>		$TC_f$	—	-72	—	ppm/K

Frequency response

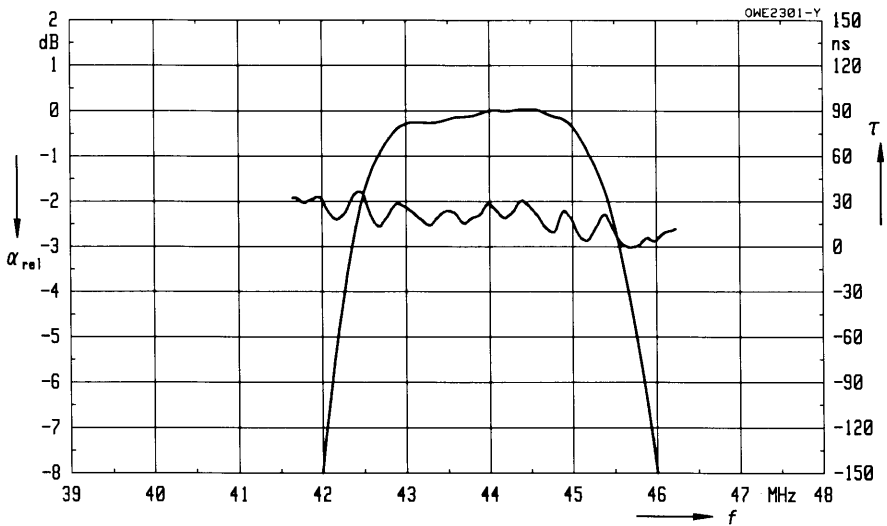
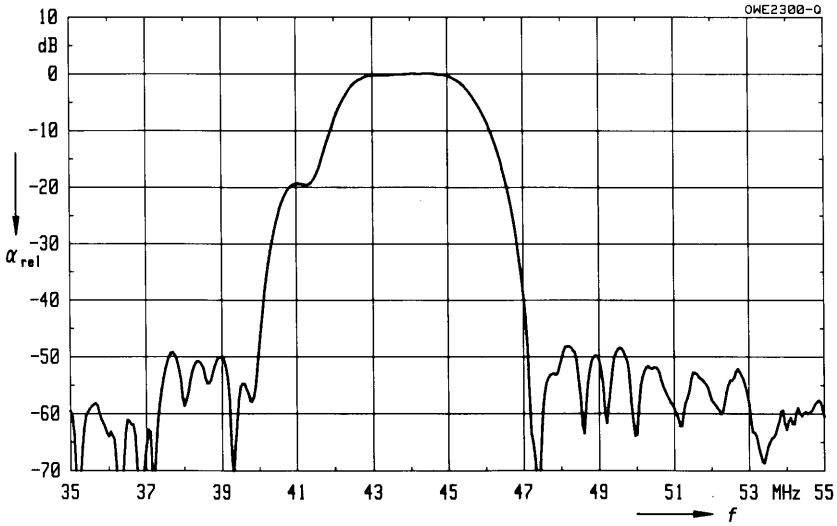

### Standard

- M  
Japan

### Features

- TV IF filter with Nyquist slope and sound shelf
- Constant group delay

### Terminals

- Tinned CuFe alloy

Plastic package **SIP 5 K**

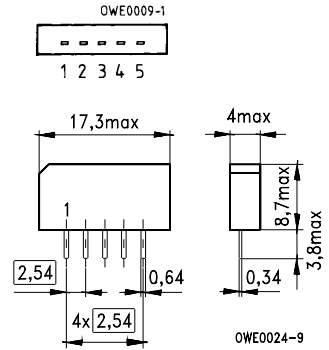

Dimensions in mm, approx. weight 1,0 g

### Pin configuration

- 1 Input
- 2 Input – ground
- 3 Chip carrier – ground
- 4 Output
- 5 Output

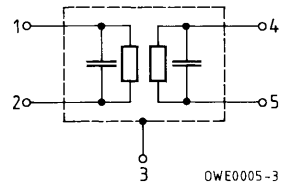

Type	Ordering code	Marking
N 1951 M	B39588-N1951-M100	Type, date code, pin 1

### Maximum ratings

Ambient temperature	$T_A$	- 25/+ 65	°C	—
Storage temperature	$T_{stg}$	- 25/+ 85	°C	—
DC voltage	$V_{DC}$	12	V	between any terminals
AC voltage	$V_{pp}$	10	V	between any terminals



**Characteristics**

Ambient temperature  $T_A = 25 (45) \text{ }^\circ\text{C}$   
 Source impedance  $Z_S = 50 \text{ } \Omega$   
 Load impedance  $Z_L = 2 \text{ k}\Omega \parallel 3 \text{ pF}$

		min.	typ.	max.		
<b>Insertion attenuation</b>						
Reference level for the following data	57,08 (57,00) MHz	$\alpha$	10,8	12,3	13,8	dB
<b>Relative attenuation</b>						
Picture carrier	58,83 (58,75) MHz	$\alpha_{rel}$	4,0	5,0	6,0	dB
Color carrier	55,25 (55,17) MHz		3,0	4,0	5,0	dB
Sound carrier	54,33 (54,25) MHz		17,0	18,0	19,0	dB
Adjacent picture carrier	52,83 (52,75) MHz		42,0	50,0	—	dB
Adjacent sound carrier	60,33 (60,25) MHz		38,0	43,0	—	dB
Lower sidelobe						
45,08 ... 52,83 (45,00 ... 52,75) MHz			36,0	42,0	—	dB
Upper sidelobe						
60,33 ... 65,08 (60,25 ... 65,00) MHz			35,0	41,0	—	dB
<b>Reflected wave signal suppression</b>						
1,0 $\mu\text{s}$ ... 6,0 $\mu\text{s}$ after main pulse (test pulse: 250 ns, carrier frequency: 57,08 MHz)			40,0	48,0	—	dB
<b>Feedthrough signal suppression</b>						
1,1 $\mu\text{s}$ ... 1,0 $\mu\text{s}$ before main pulse (test pulse: 250 ns, carrier frequency: 57,08 MHz)			50,0	56,0	—	dB
<b>Group delay ripple (p-p)</b>		$\Delta\tau$	—	50	—	ns
<b>Impedance at 57,08 MHz</b>						
Input: $Z_{IN} = R_{IN} \parallel C_{IN}$			—	1,0 $\parallel$ 7,7	—	k $\Omega$ $\parallel$ pF
Output: $Z_{OUT} = R_{OUT} \parallel C_{OUT}$			—	0,9 $\parallel$ 2,9	—	k $\Omega$ $\parallel$ pF
<b>Temperature coefficient of frequency</b>		$TC_f$	—	-72	—	ppm/K

**N 1951 M**  
**58,75 MHz**

**Frequency response**

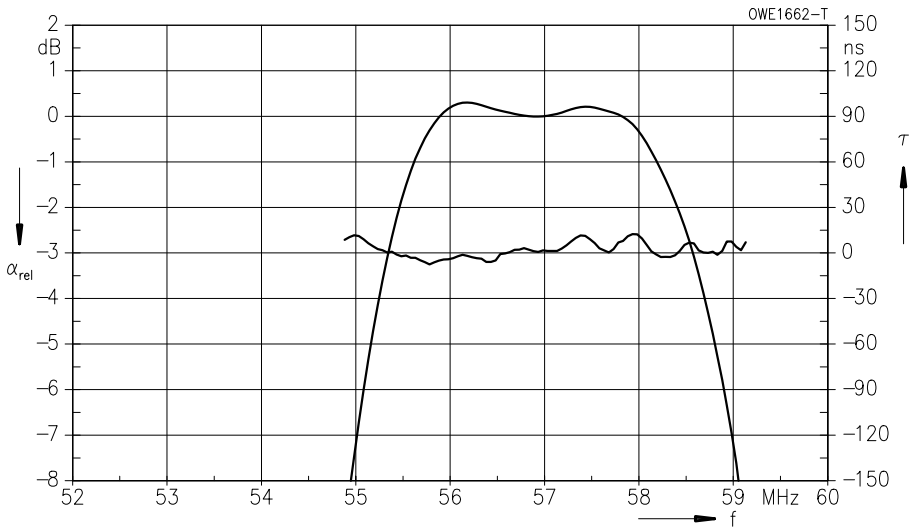
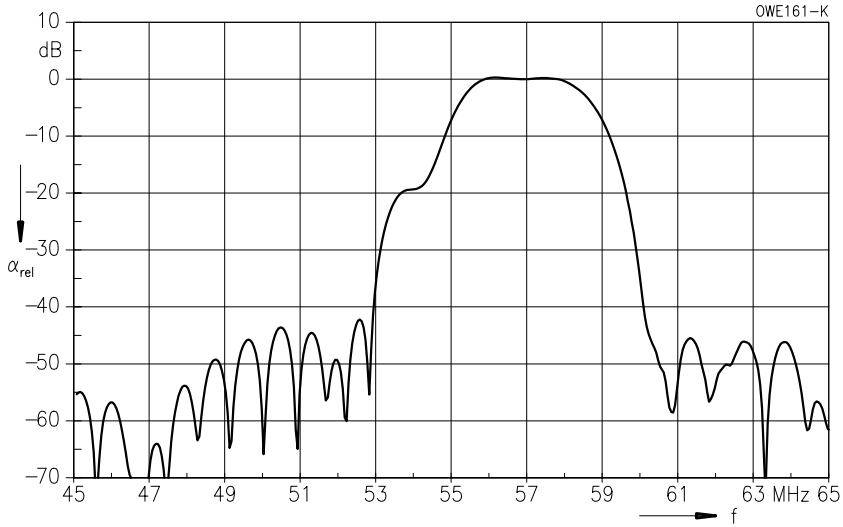

# IF Filters for Quasi/Split Sound Applications

## Survey

Picture carrier	Picture-to-sound carrier distance	Group delay <sup>1)</sup>	Sound carrier rejection <sup>2)</sup>	Standard <sup>3)</sup>	Package	Type	Page <sup>4)</sup>
MHz	MHz	ns	dB				
33,90	- 6,5	F	51	L	DIP 10 K	K 3261 K	<a href="#">116</a>
36,88	5,5	N	50	B	DIP 10 K	B 3250 K	#
38,00	6,5 <sup>5)</sup>	F	52	D/K	DIP 10 K <sup>6)</sup>	D 3650 K	#
	5,5 ... 6,5	C	35, 39	D/K	DIP 10 K	K 3264 K	<a href="#">120</a>
38,90	5,5 ... 5,85	C	33, 23	B/G NICAM	DIP 10 K	G 3254 K	#
	5,5 ... 5,85	C	44, 46	B/G NICAM	DIP 10 K	G 3255 K	#
	5,5 ... 5,85	C	37, 25	B/G NICAM	DIP 10 K	G 3258 K	<a href="#">124</a>
	5,5 ... 5,85	C	36, 23	B/G NICAM	DIP 10 K	G 3264 K	<a href="#">128</a>
	5,5 ... 5,85	F	43, 26	B/G NICAM	DIP 10 K	G 3270 K <sup>7)</sup>	#
	5,5 ... 5,85 <sup>5)</sup>	C	41, 23	B/G NICAM	DIP 10 K <sup>6)</sup>	G 3354 K	#
	5,5 ... 5,85 <sup>5)</sup>	C	48, 25	B/G NICAM	DIP 10 K	G 3355 K	<a href="#">132</a>
	5,5 ... 5,85 <sup>5)</sup>	F	56, 45	B/G NICAM	DIP 10 K	G 3356 K	#
	5,5 ... 5,85 <sup>5)</sup>	C	50, 46	B/G NICAM	DIP 10 K <sup>6)</sup>	G 3357 K	#
	5,5 ... 5,85 <sup>5)</sup>	F	35, 23	B/G NICAM	DIP 10 K <sup>6)</sup>	G 3652 K	#
	6,0 ... 6,55	F	44, 48	I NICAM	DIP 10 K	J 3251 K	<a href="#">136</a>
	6,0 ... 6,55 <sup>5)</sup>	F	43, 47	I NICAM	DIP 10 K <sup>6)</sup>	J 3351 K	<a href="#">140</a>
	6,0 ... 6,55 <sup>5)</sup>	F	56, 52	I NICAM	DIP 10 K <sup>6)</sup>	J 3652 K	#
	6,5 <sup>5)</sup>	F	42	L	DIP 10 K	K 3252 K	#
	4,5 ... 6,5	C	44, 56, 28	B/G, D/K, I	DIP 10 K	K 3258 K	<a href="#">144</a>
5,5	F	25	B/G	DIP 10 K	K 3261 K	<a href="#">116</a>	
5,5 ... 6,5 <sup>5)</sup>	C	43, 55	B/G, D/K	DIP 10 K	K 3350 K	<a href="#">148</a>	
39,50	6,0 ... 6,55	F	59, 46	I NICAM	DIP 10 K	J 3252 K	<a href="#">152</a>
	6,0 ... 6,55 <sup>5)</sup>	F	55, 51	I NICAM	DIP 10 K	J 3352 K	<a href="#">156</a>
45,75	4,5	F	43	M/N	DIP 10 K	M 3251 K	#
	4,5	F	29	M/N	DIP 10 K	M 3271 K <sup>7)</sup>	<a href="#">160</a>
	4,5 <sup>5)</sup>	F	40	M/N	DIP 10 K	M 3352 K	#
	4,5 <sup>5)</sup>	F	28	M/N	DIP 10 K	M 3353 K	#
	4,5 <sup>5)</sup>	F	32	M/N	DIP 10 K	M 3354 K	<a href="#">164</a>
	4,5 <sup>5)</sup>	F	40	M/N	DIP 10 K <sup>6)</sup>	M 3355 K	#
	4,5 <sup>5)</sup>	F	34	M/N	SIP 5 K <sup>6)</sup>	M 3561 M	<a href="#">168</a>
	4,5 <sup>5)</sup>	C	39	M/N	DIP 10 K <sup>6)</sup>	M 3654 K	<a href="#">172</a>
58,75	4,5 <sup>5)</sup>	F	29	M	SIP 5 K <sup>6)</sup>	N 3561 M	<a href="#">177</a>

1) N: Conforming with standard  
C: Customized  
F: Flat

2) Typ., referred to filter roof

3) For explanation of standards see individual data sheets or index on page [349](#)

4) Filters marked by the sign # are only listed in the survey. Detailed information on these types upon request.

5) Sound channel with sound passband only

6) Pin configuration different from standard package

7) Optimized for twin PLL ICs

### Standard

Plastic package **DIP 10 K**

- B/G-CCIR  
Germany, Europe partly
- I  
Great Britain
- L, L'  
France

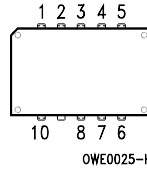

### Features

- TV IF filter for quasi/split sound applications (separate picture and sound channel)
- Picture channel with two Nyquist slopes at 33,90 MHz and 38,90 MHz
- Constant group delay
- Sound channel with pass bands for picture carrier and sound carrier at 33,40 MHz and 33,05 MHz (NICAM)

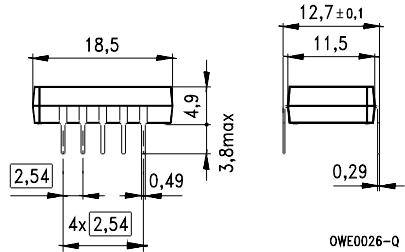

### Terminals

- Tinned CuFe alloy

Dimensions in mm, approx. weight 1,8 g

### Pin configuration

- 1 Input
- 2 Input – ground
- 3, 8 Chip carrier – ground
- 4, 5 Output – sound
- 6, 7 Output – picture
- 9 Free
- 10 Not connected

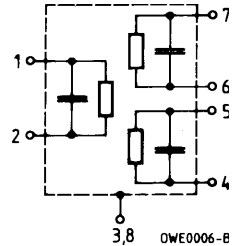

Type	Ordering code	Marking
K 3261 K	B39389-K3261-K100	Type, date code, pin 1

### Maximum ratings

Ambient temperature	$T_A$	- 25/+ 65	°C	—
Storage temperature	$T_{stg}$	- 25/+ 85	°C	—
DC voltage	$V_{DC}$	12	V	between any terminals
AC voltage	$V_{pp}$	10	V	between any terminals

**Characteristics of picture channel**

Ambient temperature  $T_A = 25\text{ °C}$   
 Source impedance  $Z_S = 50\ \Omega$   
 Load impedance  $Z_L = 2\text{ k}\Omega \parallel 3\text{ pF}$

		min.	typ.	max.	
<b>Insertion attenuation</b>					
	$\alpha$				
Reference level for the following data	37,40 MHz	14,0	15,5	17,0	dB
<b>Relative attenuation</b>					
	$\alpha_{rel}$				
	38,90 MHz	5,4	6,4	7,4	dB
	33,90 MHz	5,4	6,4	7,4	dB
Sound carrier	33,40 MHz	20,0	25,0	—	dB
Adjacent picture carrier	UHF 30,90 MHz	44,0	50,0	—	dB
	VHF 31,90 MHz	46,0	54,0	—	dB
	32,40 MHz	40,0	45,0	—	dB
	40,15 MHz	36,0	42,0	—	dB
Adjacent sound carrier	VHF 40,40 MHz	42,0	51,0	—	dB
	UHF 41,40 MHz	42,0	55,0	—	dB
Lower sidelobe	25,00 ... 32,40 MHz	38,0	46,0	—	dB
Upper sidelobe	40,40 ... 45,00 MHz	36,0	42,0	—	dB
<b>Reflected wave signal suppression</b>					
1,1 $\mu$ s ... 6,0 $\mu$ s after main pulse (test pulse: 250 ns, carrier frequency: 37,40 MHz)		42,0	53,0	—	dB
<b>Feedthrough signal suppression</b>					
1,2 $\mu$ s ... 1,0 $\mu$ s before main pulse (test pulse: 250 ns, carrier frequency: 37,40 MHz)		—	56,0	—	dB
<b>Group delay ripple (p-p)</b>					
	$\Delta\tau$	—	40	—	ns
<b>Impedance at 37,40 MHz</b>					
	Input: $Z_{IN} = R_{IN} \parallel C_{IN}$	—	1,4 $\parallel$ 23,7	—	k $\Omega$ $\parallel$ pF
	Output: $Z_{OUT} = R_{OUT} \parallel C_{OUT}$	—	1,9 $\parallel$ 4,2	—	k $\Omega$ $\parallel$ pF
<b>Temperature coefficient of frequency</b>					
	$TC_f$	—	- 72	—	ppm/K

Frequency response

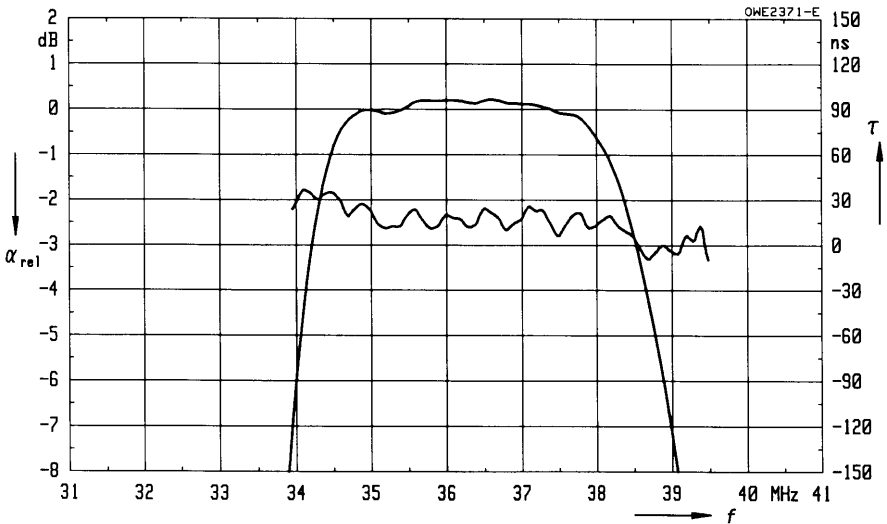
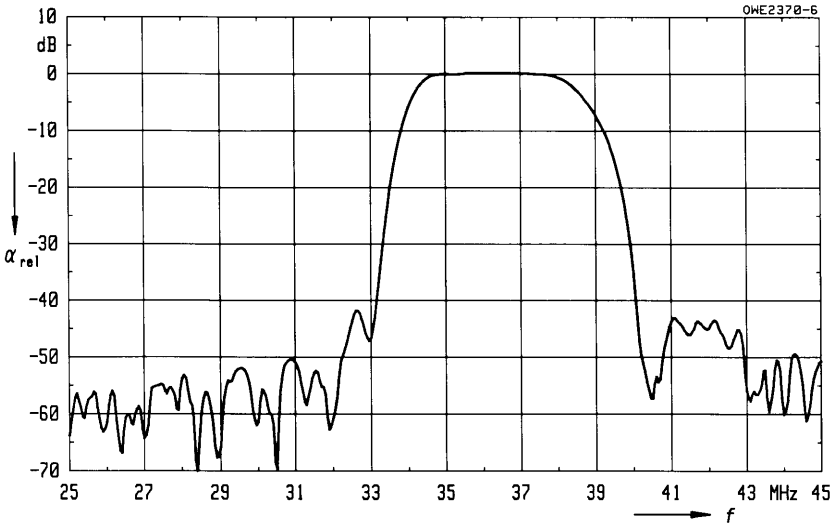

**Characteristics of sound channel**

Ambient temperature  $T_A = 25\text{ }^\circ\text{C}$   
 Source impedance  $Z_S = 50\ \Omega$   
 Load impedance  $Z_L = 2\ \text{k}\Omega \parallel 3\ \text{pF}$

		min.	typ.	max.	
<b>Insertion attenuation</b>	$\alpha$				
Reference level for the following data	38,90 MHz	19,0	20,5	22,0	dB
<b>Relative attenuation</b>	$\alpha_{\text{rel}}$				
	33,05 MHz	-1,8	-0,8	0,2	dB
Sound carrier	33,40 MHz	-0,5	0,5	1,5	dB
Color carrier	34,47 MHz	24,0	38,0	—	dB
Adjacent picture carrier	31,90 MHz	36,0	41,0	—	dB
Adjacent sound carrier	40,40 MHz	32,0	39,0	—	dB
Lower sidelobe	25,00 ... 31,90 MHz	28,0	34,0	—	dB
Upper sidelobe	40,40 ... 45,00 MHz	28,0	35,0	—	dB
<b>Group delay ripple (p-p)</b>	$\Delta\tau$	—	50	—	ns
<b>Impedance at 38,90 MHz</b>					
Output: $Z_{\text{OUT}} = R_{\text{OUT}} \parallel C_{\text{OUT}}$		—	5,3    3,5	—	k $\Omega$    pF
<b>Temperature coefficient of frequency</b>	$TC_f$	—	-72	—	ppm/K

**Frequency response**

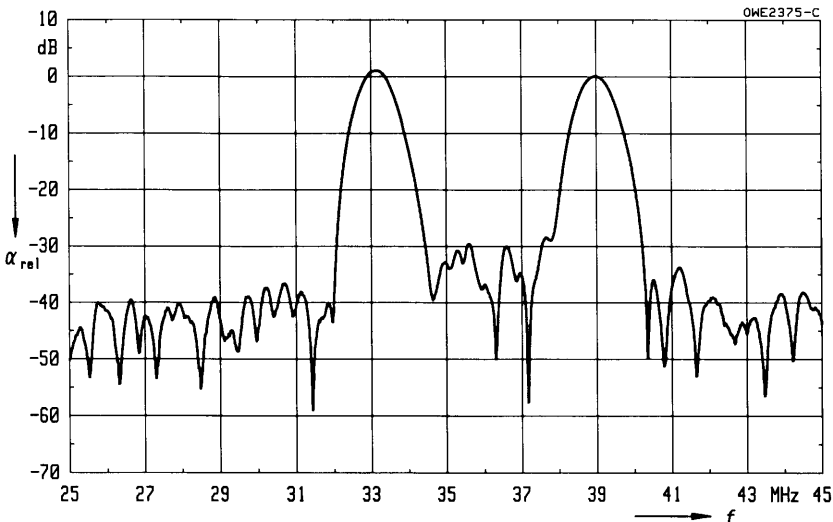

### Standard

- D/K-OIRT  
Eastern standard

Plastic package DIP 10 K

### Features

- TV IF filter for quasi/split sound applications (separate picture and sound channel)
- Picture channel with Nyquist slope and sound suppression
- Customized group delay predistortion
- Sound channel with pass bands for picture carrier and sound carrier at 31,50 MHz and 32,50 MHz

### Terminals

- Tinned CuFe alloy

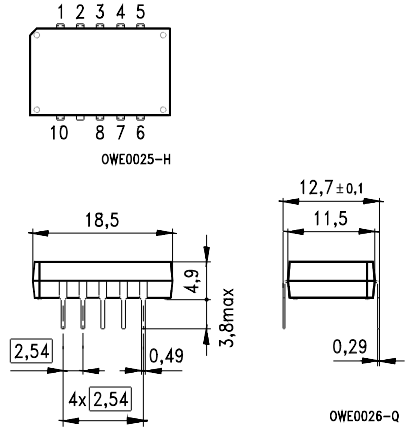

Dimensions in mm, approx. weight 1,8 g

### Pin configuration

- 1 Input
- 2 Input – ground
- 3, 8 Chip carrier – ground
- 4, 5 Output – sound
- 6, 7 Output – picture
- 9 Free
- 10 Not connected

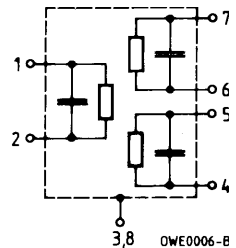

Type	Ordering code	Marking
K 3264 K	B39380-K3264-K100	Type, date code, pin 1

### Maximum ratings

Ambient temperature	$T_A$	- 25/+ 65	°C	—
Storage temperature	$T_{stg}$	- 25/+ 85	°C	—
DC voltage	$V_{DC}$	12	V	between any terminals
AC voltage	$V_{pp}$	10	V	between any terminals



**Characteristics of picture channel**

Ambient temperature  $T_A = 25\text{ }^\circ\text{C}$   
 Source impedance  $Z_S = 50\ \Omega$   
 Load impedance  $Z_L = 2\ \text{k}\Omega \parallel 3\ \text{pF}$

		min.	typ.	max.	
<b>Insertion attenuation</b>					
	$\alpha$				
Reference level for the following data	36,50 MHz	18,0	1 9,5	21,0	dB
<b>Relative attenuation</b>					
	$\alpha_{\text{rel}}$				
Picture carrier	38,00 MHz	5,2	6,2	7,2	dB
Color carrier	33,57 MHz	- 0,4	0,6	1,6	dB
	33,20 MHz	2,2	3,2	4,2	dB
Sound carrier	32,50 MHz	20,0	35,0	—	dB
	31,50 MHz	20,0	39,0	—	dB
Adjacent picture carrier	30,00 MHz	42,0	47,0	—	dB
Adjacent sound carrier	39,50 MHz	38,0	50,0	—	dB
Lower sidelobe	25,00 ... 30,00 MHz	36,0	40,0	—	dB
Upper sidelobe	39,50 ... 45,00 MHz	32,0	35,0	—	dB
<b>Reflected wave signal suppression</b>					
1,2 $\mu\text{s}$ ... 6,0 $\mu\text{s}$ after main pulse (test pulse: 250 ns, carrier frequency: 36,50 MHz)		42,0	52,0	—	dB
<b>Feedthrough signal suppression</b>					
1,2 $\mu\text{s}$ ... 1,0 $\mu\text{s}$ before main pulse (test pulse: 250 ns, carrier frequency: 36,50 MHz)		—	56,0	—	dB
<b>Group delay predistortion</b>					
	$\Delta\tau$				
(reference frequency 38,00 MHz)					
	35,20 MHz	—	- 75	—	ns
	33,57 MHz	—	- 15	—	ns
<b>Impedance at 36,50 MHz</b>					
Input: $Z_{\text{IN}} = R_{\text{IN}} \parallel C_{\text{IN}}$		—	2,1 $\parallel$ 18,8	—	k $\Omega$ $\parallel$ pF
Output: $Z_{\text{OUT}} = R_{\text{OUT}} \parallel C_{\text{OUT}}$		—	3,6 $\parallel$ 2,7	—	k $\Omega$ $\parallel$ pF
<b>Temperature coefficient of frequency</b>					
	$TC_f$	—	- 72	—	ppm/K

Frequency response

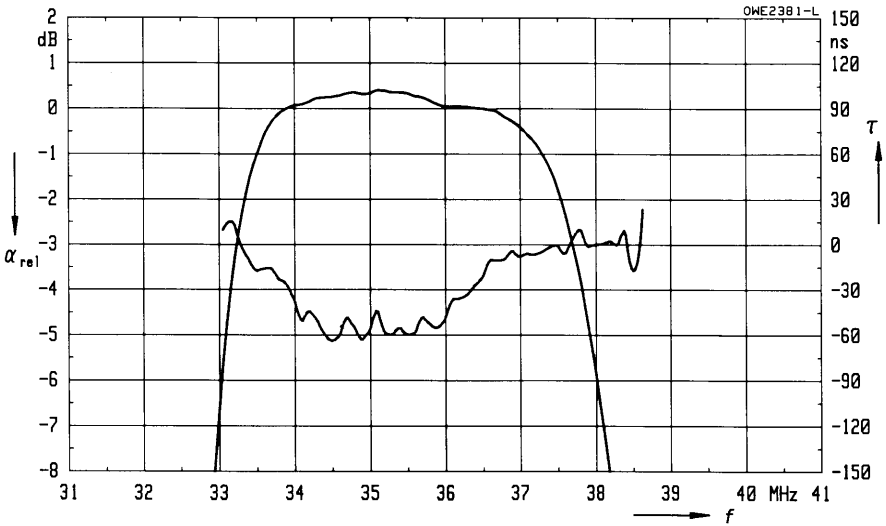
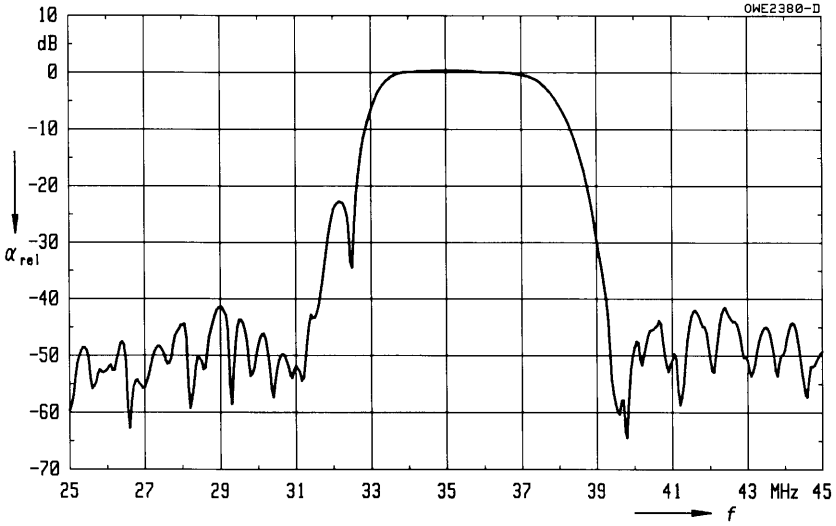

**Characteristics of sound channel**

Ambient temperature  $T_A = 25\text{ °C}$   
 Source impedance  $Z_S = 50\ \Omega$   
 Load impedance  $Z_L = 2\text{ k}\Omega \parallel 3\text{ pF}$

		min.	typ.	max.	
<b>Insertion attenuation</b>	$\alpha$				
Reference level for the following data	38,00 MHz	20,0	21,5	23,0	dB
<b>Relative attenuation</b>	$\alpha_{rel}$				
Sound carrier	31,50 MHz	-1,6	-0,6	0,4	dB
	32,50 MHz	-0,8	0,2	1,2	dB
Color carrier	33,57 MHz	18,0	24,0	—	dB
Adjacent picture carrier	30,00 MHz	36,0	41,0	—	dB
Adjacent sound carrier	39,50 MHz	30,0	38,0	—	dB
Lower sidelobe	25,00 ... 30,00 MHz	30,0	36,0	—	dB
Upper sidelobe	39,50 ... 45,00 MHz	24,0	31,0	—	dB
<b>Impedance at 38,00 MHz</b>					
Output: $Z_{OUT} = R_{OUT} \parallel C_{OUT}$		—	4,6 $\parallel$ 3,2	—	k $\Omega$ $\parallel$ pF
<b>Temperature coefficient of frequency</b>	$TC_f$	—	-72	—	ppm/K

**Frequency response**

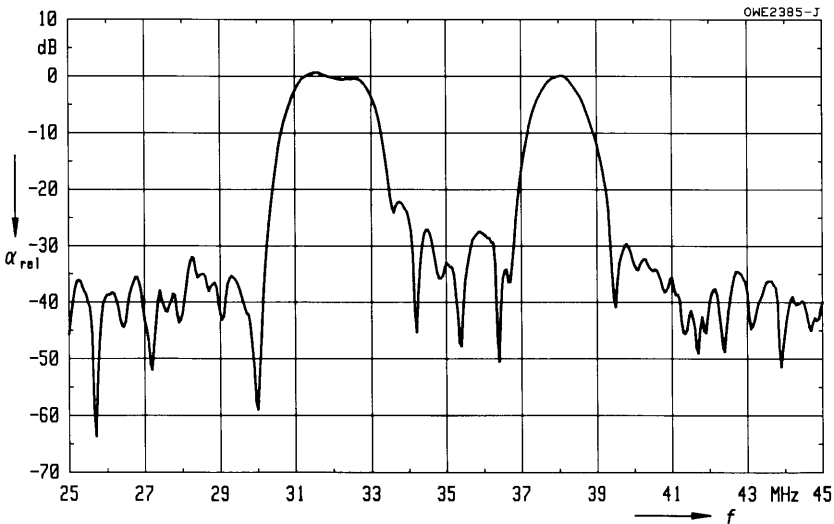

## Standard

Plastic package **DIP 10 K**

- B/G-CCIR  
Germany, Europe partly

## Features

- TV IF filter for quasi/split sound applications (separate picture and sound channel)
- Picture channel with Nyquist slope and sound suppression
- High color carrier level
- Reduced group delay predistortion as compared with standard B/G, half
- Sound channel with pass bands for picture carrier and sound carriers at 33,40 MHz and 33,05 MHz (NICAM)
- Suitable for CENELEC EN 55020

## Terminals

- Tinned CuFe alloy

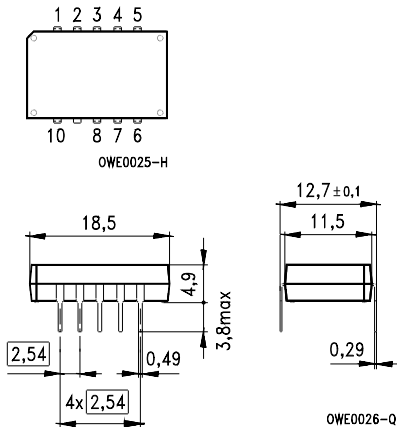

Dimensions in mm, approx. weight 1,8 g

## Pin configuration

- 1 Input
- 2 Input – ground
- 3, 8 Chip carrier – ground
- 4, 5 Output – sound
- 6, 7 Output – picture
- 9 Free
- 10 Not connected

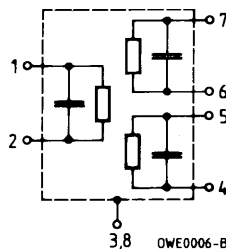

Type	Ordering code	Marking
G 3258 K	B39389-G3258-K100	Type, date code, pin 1

## Maximum ratings

Ambient temperature	$T_A$	- 25/+ 65	°C	—
Storage temperature	$T_{stg}$	- 25/+ 85	°C	—
DC voltage	$V_{DC}$	12	V	between any terminals
AC voltage	$V_{pp}$	10	V	between any terminals

**Characteristics of picture channel**

Ambient temperature  $T_A = 25\text{ °C}$   
 Source impedance  $Z_S = 50\ \Omega$   
 Load impedance  $Z_L = 2\text{ k}\Omega \parallel 3\text{ pF}$

		min.	typ.	max.	
<b>Insertion attenuation</b>					
	$\alpha$				
Reference level for the following data	37,40 MHz	14,3	15,8	17,3	dB
<b>Relative attenuation</b>					
	$\alpha_{rel}$				
Picture carrier	38,90 MHz	5,2	6,2	7,2	dB
Color carrier	34,47 MHz	-0,8	0,2	1,2	dB
Sound carrier	33,40 MHz	28,0	37,0	—	dB
Adjacent picture carrier	UHF 30,90 MHz	45,0	56,0	—	dB
	VHF 31,90 MHz	46,0	58,0	—	dB
	32,40 MHz	42,0	49,0	—	dB
	40,15 MHz	37,0	42,0	—	dB
Adjacent sound carrier	VHF 40,40 MHz	45,0	58,0	—	dB
	UHF 41,40 MHz	42,0	55,0	—	dB
Lower sidelobe	25,00 ... 31,90 MHz	42,0	49,0	—	dB
Upper sidelobe	40,40 ... 45,00 MHz	38,0	44,0	—	dB
<b>Reflected wave signal suppression</b>					
1,2 $\mu$ s ... 6,0 $\mu$ s after main pulse (test pulse: 250 ns, carrier frequency: 37,40 MHz)		42,0	54,0	—	dB
<b>Feedthrough signal suppression</b>					
1,3 $\mu$ s ... 1,2 $\mu$ s before main pulse (test pulse: 250 ns, carrier frequency: 37,40 MHz)		—	56,0	—	dB
<b>Group delay predistortion</b>					
	$\Delta\tau$				
(reference frequency 38,90 MHz)					
	36,40 MHz	—	-35	—	ns
	34,47 MHz	—	40	—	ns
<b>Impedance at 37,40 MHz</b>					
	Input: $Z_{IN} = R_{IN} \parallel C_{IN}$	—	1,4 $\parallel$ 24,7	—	k $\Omega$ $\parallel$ pF
	Output: $Z_{OUT} = R_{OUT} \parallel C_{OUT}$	—	1,9 $\parallel$ 3,5	—	k $\Omega$ $\parallel$ pF
<b>Temperature coefficient of frequency</b>					
	$TC_f$	—	-72	—	ppm/K

Frequency response

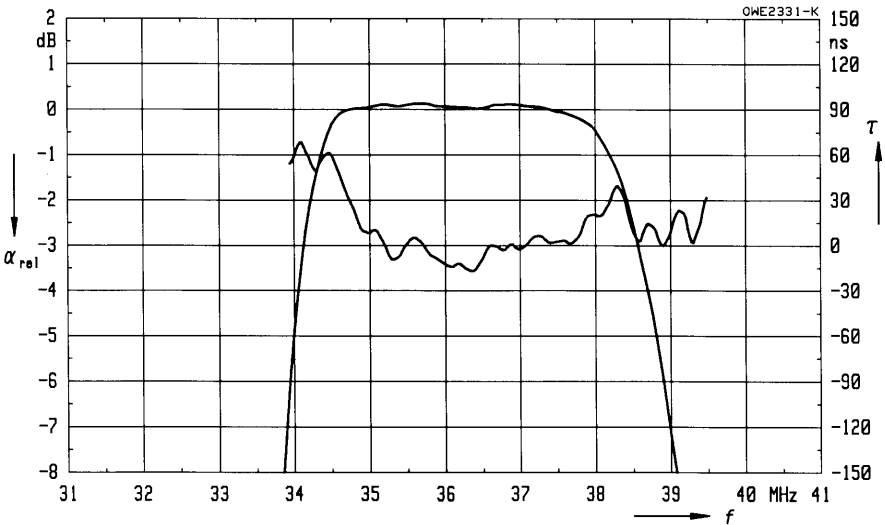
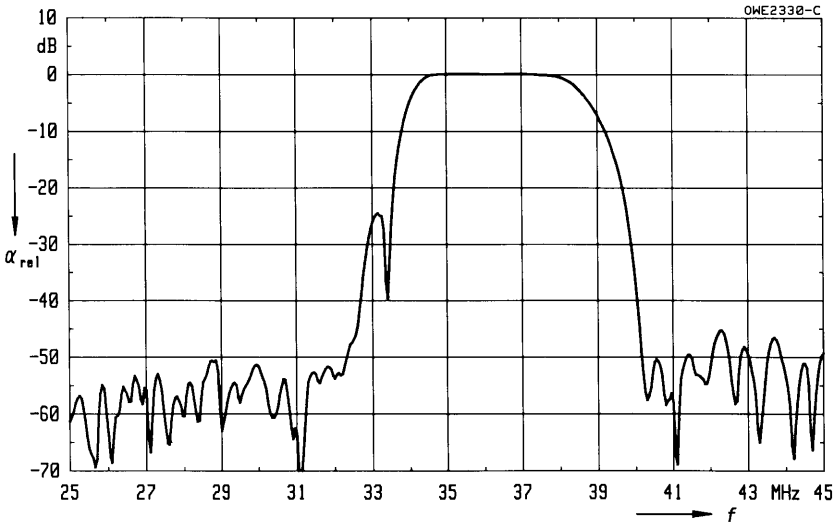

**Characteristics of sound channel**

Ambient temperature  $T_A = 25\text{ }^\circ\text{C}$   
 Source impedance  $Z_S = 50\text{ }\Omega$   
 Load impedance  $Z_L = 2\text{ k}\Omega \parallel 3\text{ pF}$

		min.	typ.	max.	
<b>Insertion attenuation</b>					
	$\alpha$				
Reference level for the following data	33,05 MHz	18,3	19,8	21,3	dB
<b>Relative attenuation</b>					
	$\alpha_{rel}$				
Sound carrier	33,40 MHz	0,5	1,5	2,5	dB
Picture carrier	38,90 MHz	0,1	1,1	2,1	dB
Color carrier	34,47 MHz	24,0	30,0	—	dB
Adjacent picture carrier	UHF 30,90 MHz	38,0	46,0	—	dB
	VHF 31,90 MHz	39,0	48,0	—	dB
Adjacent sound carrier	VHF 40,40 MHz	34,0	42,0	—	dB
	UHF 41,40 MHz	36,0	44,0	—	dB
Lower sidelobe	25,00 ... 31,90 MHz	30,0	37,0	—	dB
Upper sidelobe	40,40 ... 45,00 MHz	30,0	37,0	—	dB
<b>Impedance at 33,05 MHz</b>					
	Output: $Z_{OUT} = R_{OUT} \parallel C_{OUT}$	—	11,7 $\parallel$ 4,5	—	k $\Omega$ $\parallel$ pF
<b>Temperature coefficient of frequency</b>					
	$TC_f$	—	-72	—	ppm/K

**Frequency response**

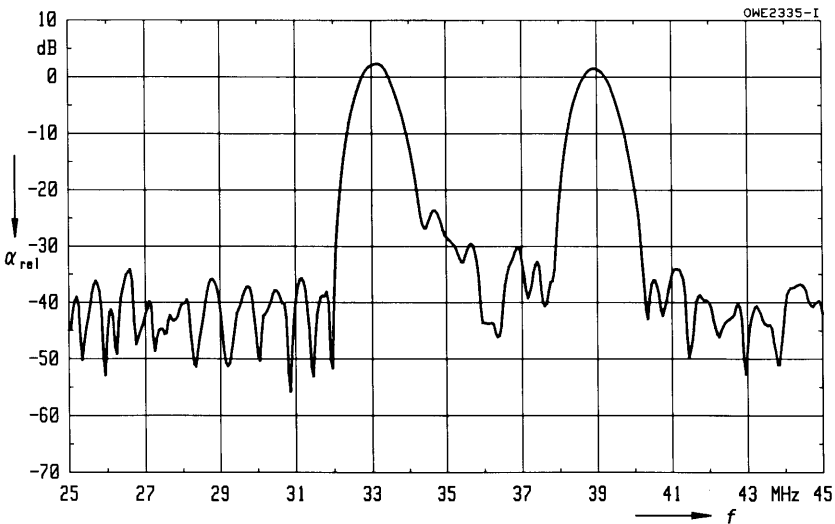

### Standard

Plastic package **DIP 10 K**

- B/G-CCIR  
Germany, Europe partly

### Features

- TV IF filter for quasi/split sound applications (separate picture and sound channel)
- Picture channel with Nyquist slope and sound suppression
- High color carrier level
- Reduced group delay predistortion as compared with standard B/G, half
- Sound channel with pass bands for picture carrier and sound carriers at 33,40 MHz and 33,05 MHz (NICAM)
- Suitable for CENELEC EN 55020

### Terminals

- Tinned CuFe alloy

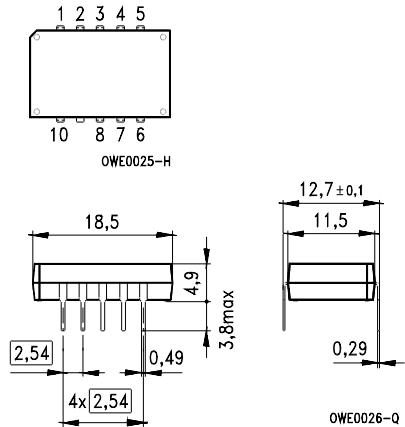

Dimensions in mm, approx. weight 1,8 g

### Pin configuration

- 1 Input
- 2 Input – ground
- 3, 8 Chip carrier – ground
- 4, 5 Output – sound
- 6, 7 Output – picture
- 9 Free
- 10 Not connected

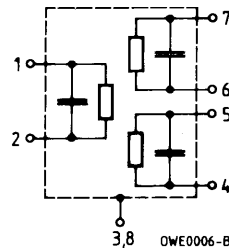

Type	Ordering code	Marking
G 3264 K	B39389-G3264-K100	Type, date code, pin 1

### Maximum ratings

Ambient temperature	$T_A$	- 25/+ 65	°C	—
Storage temperature	$T_{stg}$	- 25/+ 85	°C	—
DC voltage	$V_{DC}$	12	V	between any terminals
AC voltage	$V_{pp}$	10	V	between any terminals



**Characteristics of picture channel**

Ambient temperature  $T_A = 25\text{ }^\circ\text{C}$   
 Source impedance  $Z_S = 50\ \Omega$   
 Load impedance  $Z_L = 2\ \text{k}\Omega \parallel 3\ \text{pF}$

		min.	typ.	max.	
<b>Insertion attenuation</b>					
	$\alpha$				
Reference level for the following data	37,40 MHz	14,5	16,0	17,5	dB
<b>Relative attenuation</b>					
	$\alpha_{\text{rel}}$				
Picture carrier	38,90 MHz	5,1	6,1	7,1	dB
Color carrier	34,47 MHz	-0,9	0,1	1,1	dB
Sound carrier	33,40 MHz	26,0	36,0	—	dB
Adjacent picture carrier	UHF 30,90 MHz	44,0	53,0	—	dB
	VHF 31,90 MHz	46,0	60,0	—	dB
	32,40 MHz	42,0	53,0	—	dB
	40,15 MHz	40,0	47,0	—	dB
Adjacent sound carrier	VHF 40,40 MHz	46,0	57,0	—	dB
	UHF 41,40 MHz	44,0	54,0	—	dB
Lower sidelobe	25,00 ... 31,90 MHz	39,0	44,0	—	dB
Upper sidelobe	40,40 ... 45,00 MHz	39,0	45,0	—	dB
<b>Reflected wave signal suppression</b>					
1,2 $\mu\text{s}$ ... 6,0 $\mu\text{s}$ after main pulse (test pulse: 250 ns, carrier frequency: 37,40 MHz)		42,0	55,0	—	dB
<b>Feedthrough signal suppression</b>					
1,2 $\mu\text{s}$ ... 1,0 $\mu\text{s}$ before main pulse (test pulse: 250 ns, carrier frequency: 37,40 MHz)		—	56,0	—	dB
<b>Group delay predistortion</b>					
	$\Delta\tau$				
(reference frequency 38,90 MHz)					
	36,10 MHz	—	-70	—	ns
	34,47 MHz	—	120	—	ns
<b>Impedance at 37,40 MHz</b>					
	Input: $Z_{\text{IN}} = R_{\text{IN}} \parallel C_{\text{IN}}$	—	1,3 $\parallel$ 25,0	—	k $\Omega$ $\parallel$ pF
	Output: $Z_{\text{OUT}} = R_{\text{OUT}} \parallel C_{\text{OUT}}$	—	1,7 $\parallel$ 3,7	—	k $\Omega$ $\parallel$ pF
<b>Temperature coefficient of frequency</b>					
	$TC_f$	—	-72	—	ppm/K

Frequency response

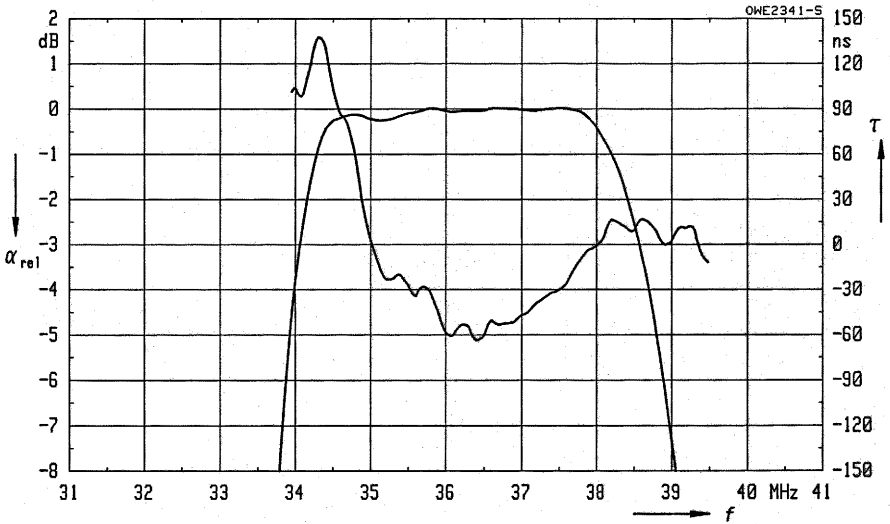
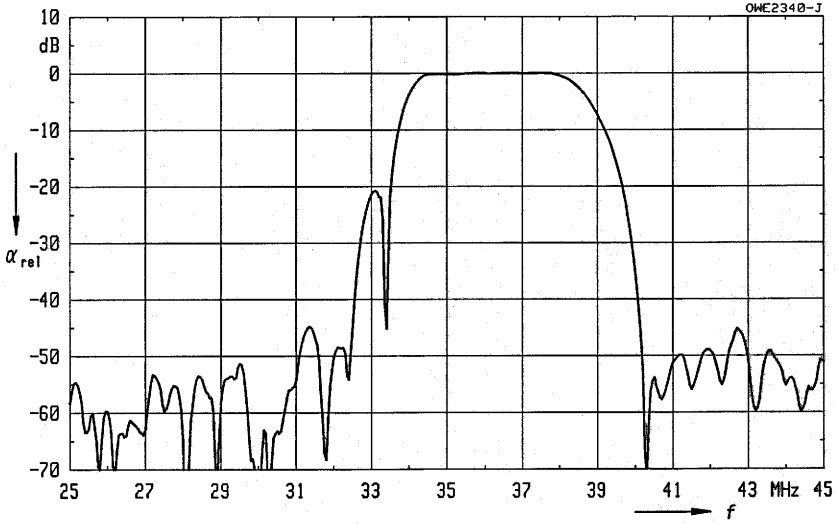

**Characteristics of sound channel**

Ambient temperature  $T_A = 25\text{ °C}$   
 Source impedance  $Z_S = 50\ \Omega$   
 Load impedance  $Z_L = 2\text{ k}\Omega \parallel 3\text{ pF}$

		min.	typ.	max.	
<b>Insertion attenuation</b>	$\alpha$				
Reference level for the following data	38,90 MHz	18,6	20,1	21,6	dB
<b>Relative attenuation</b>	$\alpha_{rel}$				
Sound carrier	33,40 MHz	-0,9	0,3	1,5	dB
NICAM sound carrier	33,05 MHz	-2,0	-1,0	0,0	dB
Color carrier	34,47 MHz	20,0	29,0	—	dB
In-band trap	36,15 MHz	25,0	37,0	—	dB
Adjacent picture carrier	31,90 MHz	36,0	45,0	—	dB
Adjacent sound carrier	40,40 MHz	30,0	39,0	—	dB
Lower sidelobe	25,00 ... 31,90 MHz	28,0	38,0	—	dB
Upper sidelobe	40,40 ... 45,00 MHz	26,0	35,0	—	dB
<b>Group delay ripple (p-p)</b>	$\Delta\tau$	—	40	—	ns
<b>Impedance at 38,90 MHz</b>					
Output: $Z_{OUT} = R_{OUT} \parallel C_{OUT}$		—	5,4    3,1	—	k $\Omega$    pF
<b>Temperature coefficient of frequency</b>	$TC_f$	—	-72	—	ppm/K

**Frequency response**

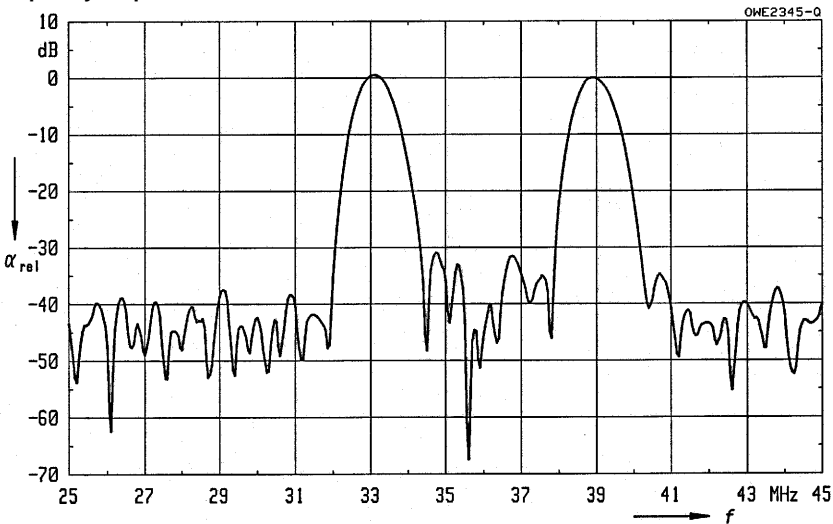

### Standard

Plastic package DIP 10 K

- B/G-CCIR  
Germany, Europe partly

### Features

- TV IF filter for quasi/split sound applications (separate picture and sound channel)
- Picture channel with Nyquist slope and sound suppression
- Customized group delay predistortion
- Sound channel with pass bands for sound carriers at 33,40 MHz and 33,05 MHz (NICAM)
- Suitable for CENELEC EN 55020

### Terminals

- Tinned CuFe alloy

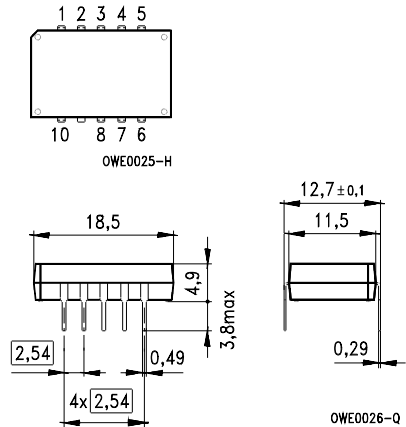

Dimensions in mm, approx. weight 1,8 g

### Pin configuration

- 1 Input
- 2 Input – ground
- 3, 8 Chip carrier – ground
- 4, 5 Output – sound
- 6, 7 Output – picture
- 9 Free
- 10 Not connected

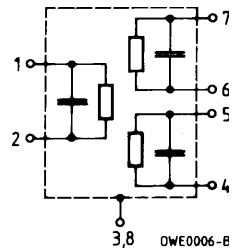

Type	Ordering code	Marking
G 3355 K	B39389-G3355-K100	Type, date code, pin 1

### Maximum ratings

Ambient temperature	$T_A$	- 25/+ 65	°C	—
Storage temperature	$T_{stg}$	- 25/+ 85	°C	—
DC voltage	$V_{DC}$	12	V	between any terminals
AC voltage	$V_{pp}$	10	V	between any terminals

**Characteristics of picture channel**

Ambient temperature  $T_A = 25\text{ }^\circ\text{C}$   
 Source impedance  $Z_S = 50\ \Omega$   
 Load impedance  $Z_L = 2\ \text{k}\Omega \parallel 3\ \text{pF}$

		min.	typ.	max.	
<b>Insertion attenuation</b>					
	$\alpha$				
Reference level for the following data	37,40 MHz	13,5	15,0	16,5	dB
<b>Relative attenuation</b>					
	$\alpha_{\text{rel}}$				
Picture carrier	38,90 MHz	5,5	6,5	7,5	dB
Color carrier	34,47 MHz	-0,6	0,4	1,4	dB
Sound carrier	33,40 MHz	30,0	48,0	—	dB
Adjacent picture carrier	UHF 30,90 MHz	46,0	60,0	—	dB
	VHF 31,90 MHz	48,0	56,0	—	dB
	32,40 MHz	46,0	55,0	—	dB
	40,15 MHz	40,0	48,0	—	dB
Adjacent sound carrier	VHF 40,40 MHz	46,0	60,0	—	dB
	UHF 41,40 MHz	45,0	59,0	—	dB
Lower sidelobe	25,00 ... 31,90 MHz	40,0	46,0	—	dB
Upper sidelobe	40,40 ... 45,00 MHz	40,0	46,0	—	dB
<b>Reflected wave signal suppression</b>					
1,2 $\mu\text{s}$ ... 6,0 $\mu\text{s}$ after main pulse (test pulse: 250 ns, carrier frequency: 37,40 MHz)		42,0	52,0	—	dB
<b>Feedthrough signal suppression</b>					
1,2 $\mu\text{s}$ ... 1,1 $\mu\text{s}$ before main pulse (test pulse: 250 ns, carrier frequency: 37,40 MHz)		50,0	56,0	—	dB
<b>Group delay predistortion</b>					
	$\Delta\tau$				
(reference frequency 38,90 MHz)					
	36,40 MHz	—	-55	—	ns
	34,47 MHz	—	40	—	ns
<b>Impedance at 37,40 MHz</b>					
	Input: $Z_{\text{IN}} = R_{\text{IN}} \parallel C_{\text{IN}}$	—	1,0 $\parallel$ 24,4	—	k $\Omega$ $\parallel$ pF
	Output: $Z_{\text{OUT}} = R_{\text{OUT}} \parallel C_{\text{OUT}}$	—	1,6 $\parallel$ 3,9	—	k $\Omega$ $\parallel$ pF
<b>Temperature coefficient of frequency</b>					
	$TC_f$	—	-72	—	ppm/K

Frequency response

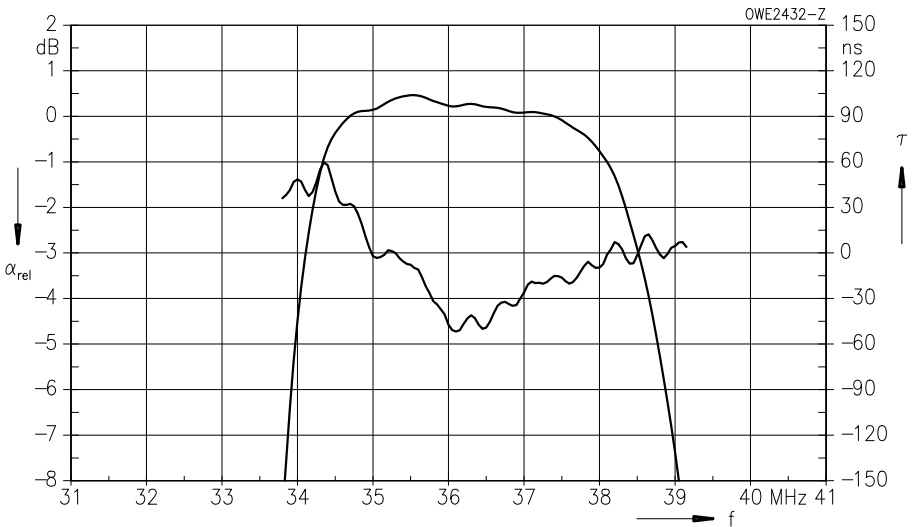
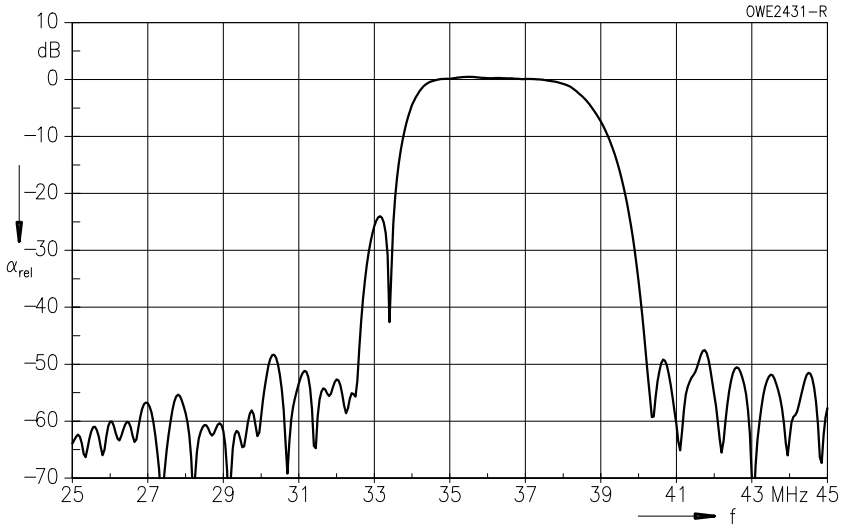

**Characteristics of sound channel**

Ambient temperature  $T_A = 25\text{ °C}$   
 Source impedance  $Z_S = 50\ \Omega$   
 Load impedance  $Z_L = 2\text{ k}\Omega \parallel 3\text{ pF}$

		min.	typ.	max.	
<b>Insertion attenuation</b>					
	$\alpha$				
Reference level for the following data	33,05 MHz	14,8	16,3	17,8	dB
<b>Relative attenuation</b>					
	$\alpha_{rel}$				
Sound carrier	33,40 MHz	1,0	2,0	3,0	dB
Picture carrier	38,90 MHz	42,0	56,0	—	dB
Color carrier	34,47 MHz	28,0	35,0	—	dB
Adjacent picture carrier	UHF 30,90 MHz	30,0	37,0	—	dB
	VHF 31,90 MHz	32,0	41,0	—	dB
Adjacent sound carrier	VHF 40,40 MHz	42,0	53,0	—	dB
	UHF 41,40 MHz	42,0	54,0	—	dB
Lower sidelobe	25,00 ... 31,90 MHz	28,0	34,0	—	dB
Upper sidelobe	38,90 ... 45,00 MHz	38,0	46,0	—	dB
<b>Impedance at 33,05 MHz</b>					
Output: $Z_{OUT} = R_{OUT} \parallel C_{OUT}$		—	4,1    2,6	—	k $\Omega$    pF
<b>Temperature coefficient of frequency</b>					
	$TC_f$	—	-72	—	ppm/K

**Frequency response**

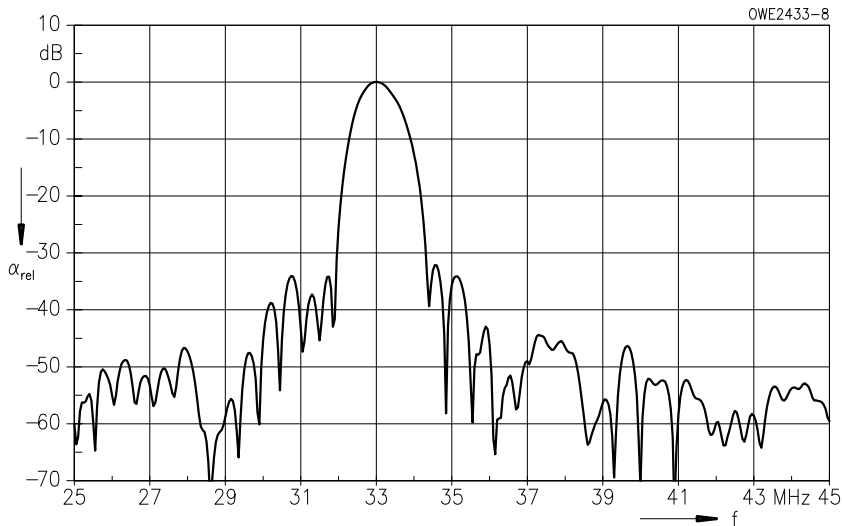

### Standard

Plastic package DIP 10 K

- I  
Great Britain

### Features

- TV IF filter for quasi/split sound applications (separate picture and sound channel)
- Picture channel with Nyquist slope and sound suppression
- Constant group delay
- Sound channel with pass bands for picture carrier and sound carriers at 32,90 MHz and 32,35 MHz (NICAM)

### Terminals

- Tinned CuFe alloy

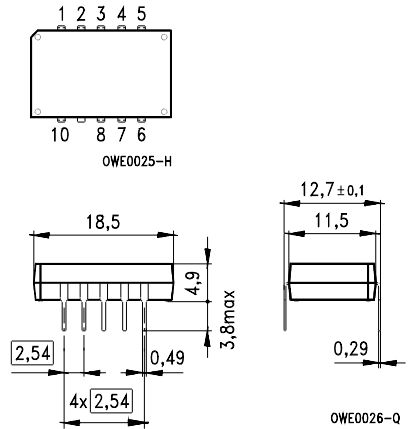

Dimensions in mm, approx. weight 1,8 g

### Pin configuration

- 1 Input
- 2 Input – ground
- 3, 8 Chip carrier – ground
- 4, 5 Output – sound
- 6, 7 Output – picture
- 9 Free
- 10 Not connected

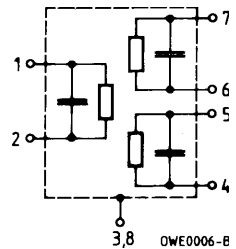

Type	Ordering code	Marking
J 3251 K	B39389-J3251-K100	Type, date code, pin 1

### Maximum ratings

Ambient temperature	$T_A$	- 25/+ 65	°C	—
Storage temperature	$T_{stg}$	- 25/+ 85	°C	—
DC voltage	$V_{DC}$	12	V	between any terminals
AC voltage	$V_{pp}$	10	V	between any terminals



**Characteristics of picture channel**

Ambient temperature  $T_A = 25\text{ °C}$   
 Source impedance  $Z_S = 50\ \Omega$   
 Load impedance  $Z_L = 2\text{ k}\Omega \parallel 3\text{ pF}$

		min.	typ.	max.	
<b>Insertion attenuation</b>					
	$\alpha$				
Reference level for the following data	37,00 MHz	15,0	16,5	18,0	dB
<b>Relative attenuation</b>					
	$\alpha_{rel}$				
Picture carrier	38,90 MHz	4,4	5,4	6,4	dB
Color carrier	34,47 MHz	2,1	3,1	4,1	dB
Sound carrier	32,90 MHz	36,0	44,0	—	dB
NICAM sound carrier	32,35 MHz	40,0	48,0	—	dB
Adjacent picture carrier	30,90 MHz	44,0	53,0	—	dB
Adjacent sound carrier	40,90 MHz	40,0	46,0	—	dB
	40,35 MHz	36,0	43,0	—	dB
Lower sidelobe	25,00 ... 32,35 MHz	38,0	45,0	—	dB
Upper sidelobe	40,90 ... 45,00 MHz	35,0	41,0	—	dB
<b>Reflected wave signal suppression</b>					
0,8 $\mu$ s ... 6,0 $\mu$ s after main pulse (test pulse: 250 ns, carrier frequency: 37,00 MHz)		42,0	50,0	—	dB
<b>Feedthrough signal suppression</b>					
1,0 $\mu$ s ... 0,9 $\mu$ s before main pulse (test pulse: 250 ns, carrier frequency: 37,00 MHz)		—	56,0	—	dB
<b>Group delay ripple (p-p)</b>	$\Delta\tau$	—	50	—	ns
<b>Impedance at 37,00 MHz</b>					
Input: $Z_{IN} = R_{IN} \parallel C_{IN}$		—	1,5 $\parallel$ 20,6	—	k $\Omega$ $\parallel$ pF
Output: $Z_{OUT} = R_{OUT} \parallel C_{OUT}$		—	2,8 $\parallel$ 4,5	—	k $\Omega$ $\parallel$ pF
<b>Temperature coefficient of frequency</b>	$TC_f$	—	-72	—	ppm/K

Frequency response

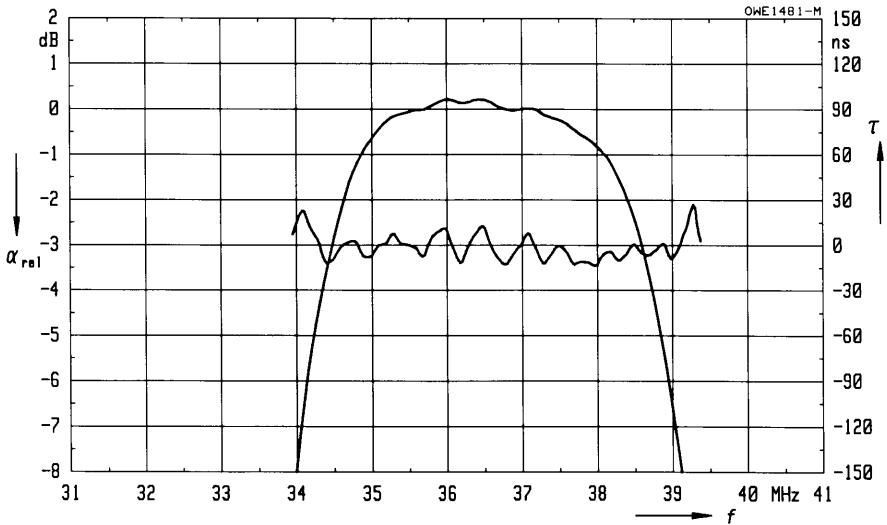
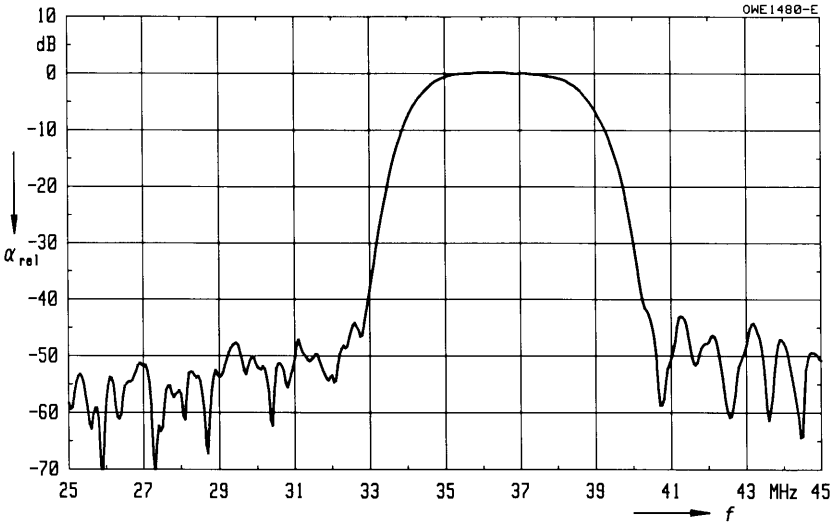

**Characteristics of sound channel**

Ambient temperature  $T_A = 25\text{ }^\circ\text{C}$   
 Source impedance  $Z_S = 50\ \Omega$   
 Load impedance  $Z_L = 2\ \text{k}\Omega \parallel 3\ \text{pF}$

		min.	typ.	max.	
<b>Insertion attenuation</b>	$\alpha$				
Reference level for the following data	38,90 MHz	22,5	24,2	25,5	dB
<b>Relative attenuation</b>	$\alpha_{rel}$				
Sound carrier	32,90 MHz	0,8	1,8	2,8	dB
NICAM sound carrier	32,35 MHz	-0,8	0,2	1,2	dB
Color carrier	34,47 MHz	18,0	28,0	—	dB
Adjacent picture carrier	30,90 MHz	33,0	44,0	—	dB
Adjacent sound carrier	40,90 MHz	30,0	38,0	—	dB
Lower sidelobe	25,00 ... 30,90 MHz	30,0	37,0	—	dB
Upper sidelobe	40,90 ... 45,00 MHz	29,0	36,0	—	dB
<b>Group delay ripple (p-p)</b>	$\Delta\tau$	—	70	—	ns
<b>Impedance at 38,90 MHz</b>					
Output: $Z_{OUT} = R_{OUT} \parallel C_{OUT}$		—	8,9    2,7	—	k $\Omega$    pF
<b>Temperature coefficient of frequency</b>	$TC_f$	—	-72	—	ppm/K

**Frequency response**

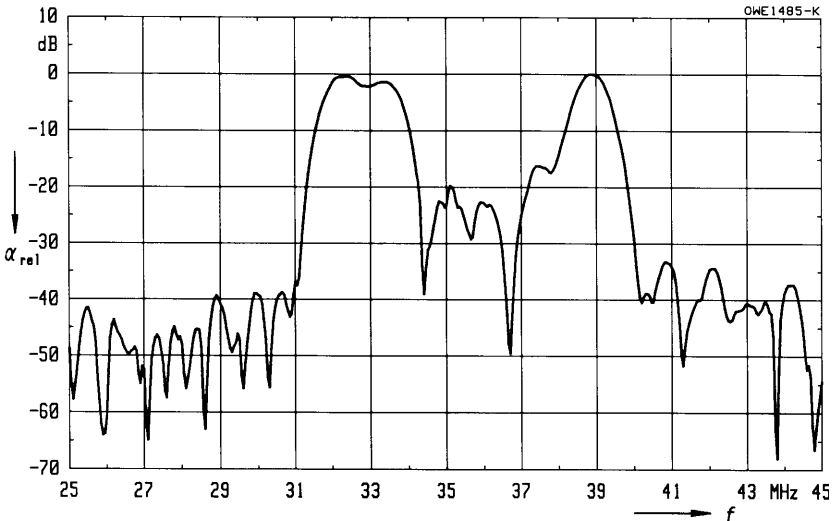

### Standard

Plastic package DIP 10 K

- I  
Great Britain

### Features

- TV IF filter for quasi/split sound applications (separate picture and sound channel)
- Picture channel with Nyquist slope and sound suppression
- Constant group delay
- Sound channel with pass bands for sound carriers at 32,90 MHz and 32,35 MHz (NICAM)

### Terminals

- Tinned CuFe alloy

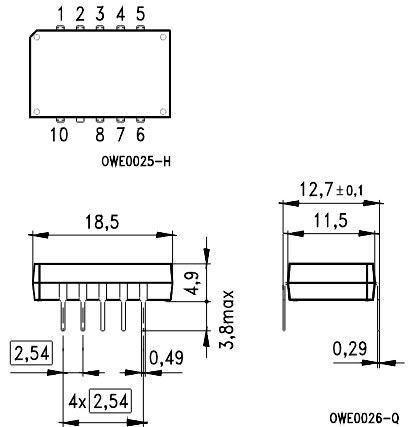

Dimensions in mm, approx. weight 1,8 g

### Pin configuration

- 1 Input
- 2 Input – ground
- 3, 8 Chip carrier – ground
- 4, 5 Output – picture
- 6, 7 Output – sound
- 9 Free
- 10 Not connected

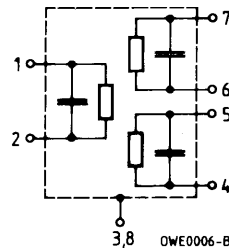

Type	Ordering code	Marking
J 3351 K	B39389-J3351-K100	Type, date code, pin 1

### Maximum ratings

Ambient temperature	$T_A$	- 25/+ 65	°C	—
Storage temperature	$T_{stg}$	- 25/+ 85	°C	—
DC voltage	$V_{DC}$	12	V	between any terminals
AC voltage	$V_{pp}$	10	V	between any terminals

**Characteristics of picture channel**

Ambient temperature  $T_A = 25\text{ }^\circ\text{C}$   
 Source impedance  $Z_S = 50\ \Omega$   
 Load impedance  $Z_L = 2\ \text{k}\Omega \parallel 3\ \text{pF}$

		min.	typ.	max.	
<b>Insertion attenuation</b>					
	$\alpha$				
Reference level for the following data	37,40 MHz	17,0	18,6	20,0	dB
<b>Relative attenuation</b>					
	$\alpha_{\text{rel}}$				
Picture carrier	38,90 MHz	4,4	5,4	6,4	dB
Color carrier	34,47 MHz	1,6	2,6	3,6	dB
Sound carrier	32,90 MHz	36,0	43,0	—	dB
NICAM sound carrier	32,35 MHz	40,0	47,0	—	dB
Adjacent picture carrier	30,90 MHz	46,0	57,0	—	dB
Adjacent sound carrier	40,90 MHz	41,0	50,0	—	dB
	40,35 MHz	37,0	43,0	—	dB
Lower sidelobe	25,00 ... 30,90 MHz	42,0	47,0	—	dB
Upper sidelobe	40,90 ... 45,00 MHz	38,0	44,0	—	dB
<b>Reflected wave signal suppression</b>					
0,8 $\mu\text{s}$ ... 6,0 $\mu\text{s}$ after main pulse (test pulse: 250 ns, carrier frequency: 37,40 MHz)		42,0	50,0	—	dB
<b>Feedthrough signal suppression</b>					
1,0 $\mu\text{s}$ ... 0,9 $\mu\text{s}$ before main pulse (test pulse: 250 ns, carrier frequency: 37,40 MHz)		—	56,0	—	dB
<b>Group delay ripple (p-p)</b>	$\Delta\tau$	—	40	—	ns
<b>Impedance at 37,40 MHz</b>					
Input: $Z_{\text{IN}} = R_{\text{IN}} \parallel C_{\text{IN}}$		—	1,9 $\parallel$ 15,3	—	k $\Omega$ $\parallel$ pF
Output: $Z_{\text{OUT}} = R_{\text{OUT}} \parallel C_{\text{OUT}}$		—	2,4 $\parallel$ 3,4	—	k $\Omega$ $\parallel$ pF
<b>Temperature coefficient of frequency</b>	$TC_f$	—	-72	—	ppm/K

**Frequency response**

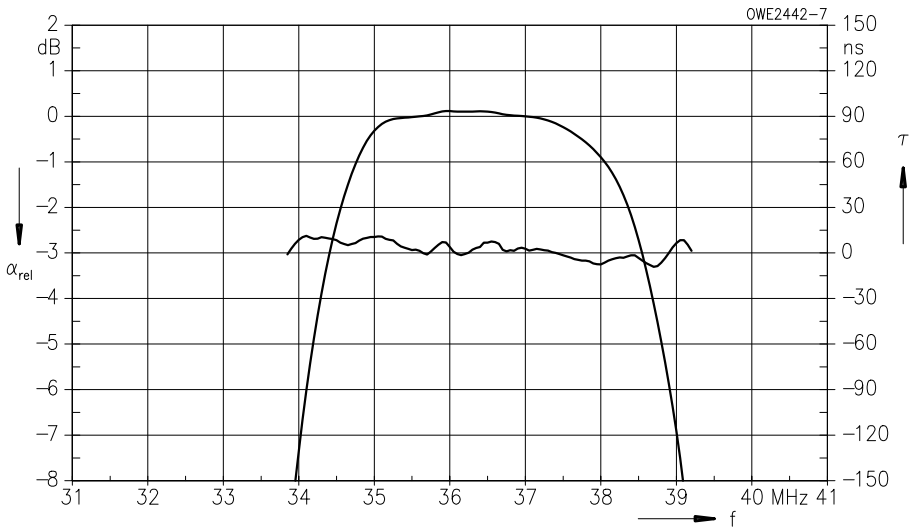
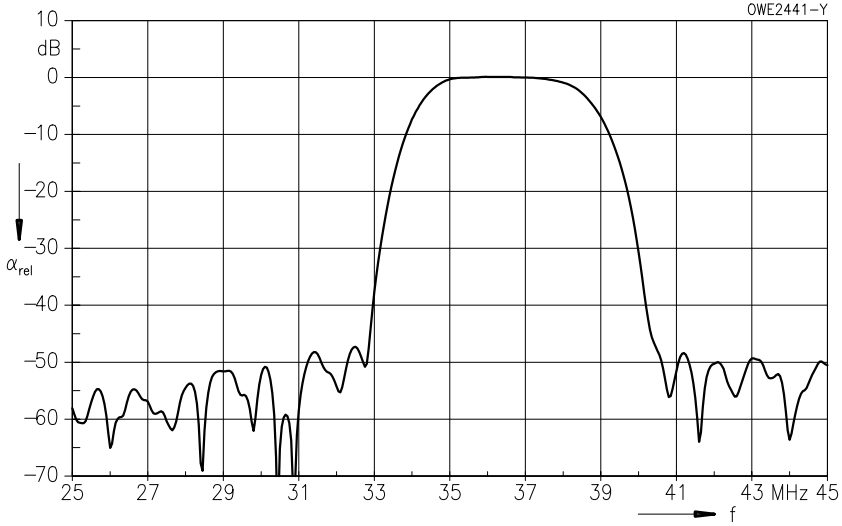

**Characteristics of sound channel**

Ambient temperature  $T_A = 25\text{ °C}$   
 Source impedance  $Z_S = 50\ \Omega$   
 Load impedance  $Z_L = 2\text{ k}\Omega \parallel 3\text{ pF}$

		min.	typ.	max.	
<b>Insertion attenuation</b>	$\alpha$				
Reference level for the following data	32,35 MHz	21,5	23,2	24,5	dB
<b>Relative attenuation</b>	$\alpha_{rel}$				
Sound carrier	32,90 MHz	- 0,8	0,2	1,2	dB
	31,95 MHz	0,1	1,1	2,1	dB
Picture carrier	38,90 MHz	40,0	53,0	—	dB
Color carrier	34,47 MHz	25,0	30,0	—	dB
Adjacent picture carrier	30,90 MHz	28,0	40,0	—	dB
Adjacent sound carrier	40,90 MHz	38,0	50,0	—	dB
Lower sidelobe	25,00 ... 30,90 MHz	28,0	33,0	—	dB
Upper sidelobe	40,90 ... 45,00 MHz	35,0	42,0	—	dB
<b>Group delay ripple (p-p)</b>	$\Delta\tau$	—	70	—	ns
<b>Impedance at 32,35 MHz</b>					
Output: $Z_{OUT} = R_{OUT} \parallel C_{OUT}$		—	4,4 $\parallel$ 3,2	—	k $\Omega$ $\parallel$ pF
<b>Temperature coefficient of frequency</b>	$TC_f$	—	-72	—	ppm/K

**Frequency response**

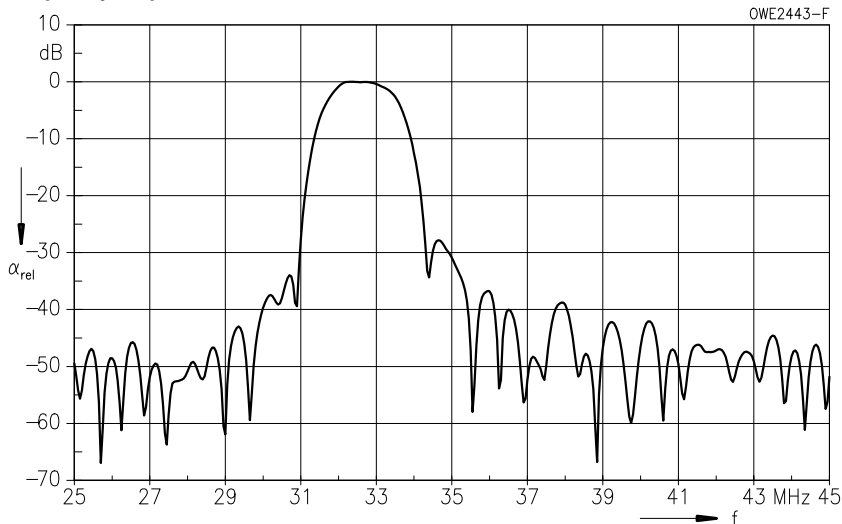

### Standard

- B/G-CCIR  
Germany, Europe partly
- D/K-OIRT  
Eastern standard
- I  
Great Britain

Plastic package DIP 10 K

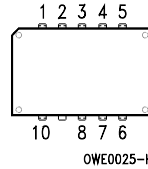

### Features

- TV IF filter for quasi/split sound applications (separate picture and sound channel)
- Picture channel with Nyquist slope and sound suppression
- High color carrier level
- Highly reduced group delay pre-distortion
- Sound channel with pass bands for picture carrier and sound carriers between 32,40 MHz and 34,40 MHz

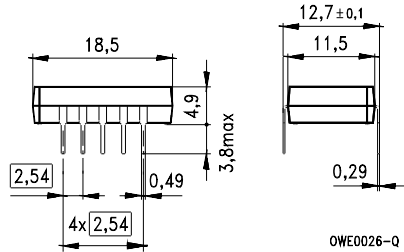

### Terminals

- Tinned CuFe alloy

Dimensions in mm, approx. weight 1,8 g

### Pin configuration

- 1 Input
- 2 Input – ground
- 3, 8 Chip carrier – ground
- 4, 5 Output – sound
- 6, 7 Output – picture
- 9 Free
- 10 Not connected

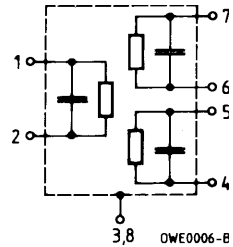

Type	Ordering code	Marking
K 3258 K	B39389-K3258-K100	Type, date code, pin 1

### Maximum ratings

Ambient temperature	$T_A$	- 25/+ 65	°C	—
Storage temperature	$T_{stg}$	- 25/+ 85	°C	—
DC voltage	$V_{DC}$	12	V	between any terminals
AC voltage	$V_{pp}$	10	V	between any terminals



**Characteristics of picture channel**

Ambient temperature  $T_A = 25\text{ °C}$   
 Source impedance  $Z_S = 50\ \Omega$   
 Load impedance  $Z_L = 2\text{ k}\Omega \parallel 3\text{ pF}$

		min.	typ.	max.	
<b>Insertion attenuation</b>					
	$\alpha$				
Reference level for the following data	37,40 MHz	14,3	15,8	17,3	dB
<b>Relative attenuation</b>					
	$\alpha_{rel}$				
Picture carrier	38,90 MHz	4,8	5,8	6,8	dB
Color carrier	34,47 MHz	- 0,7	0,3	1,3	dB
Sound carrier	33,40 MHz	30,0	44,0	—	dB
Adjacent picture carrier	UHF 30,90 MHz	42,0	49,0	—	dB
	VHF 31,90 MHz	40,0	50,0	—	dB
	32,40 MHz	44,0	56,0	—	dB
	40,15 MHz	36,0	42,0	—	dB
Adjacent sound carrier	VHF 40,40 MHz	42,0	52,0	—	dB
	UHF 41,40 MHz	40,0	48,0	—	dB
Lower sidelobe	25,00 ... 31,90 MHz	38,0	44,0	—	dB
Upper sidelobe	40,40 ... 45,00 MHz	38,0	46,0	—	dB
<b>Reflected wave signal suppression</b>					
1,3 $\mu$ s ... 6,0 $\mu$ s after main pulse (test pulse: 250 ns, carrier frequency: 37,40 MHz)		42,0	52,0	—	dB
<b>Feedthrough signal suppression</b>					
1,3 $\mu$ s ... 1,1 $\mu$ s before main pulse (test pulse: 250 ns, carrier frequency: 37,40 MHz)		—	56,0	—	dB
<b>Group delay predistortion</b>					
	$\Delta\tau$				
(reference frequency 38,90 MHz)					
	36,10 MHz	—	- 30	—	ns
	34,47 MHz	—	40	—	ns
<b>Impedance at 37,40 MHz</b>					
Input: $Z_{IN} = R_{IN} \parallel C_{IN}$		—	1,6 $\parallel$ 23,6	—	k $\Omega$ $\parallel$ pF
Output: $Z_{OUT} = R_{OUT} \parallel C_{OUT}$		—	1,9 $\parallel$ 3,5	—	k $\Omega$ $\parallel$ pF
<b>Temperature coefficient of frequency</b>					
	$TC_f$	—	- 72	—	ppm/K

Frequency response

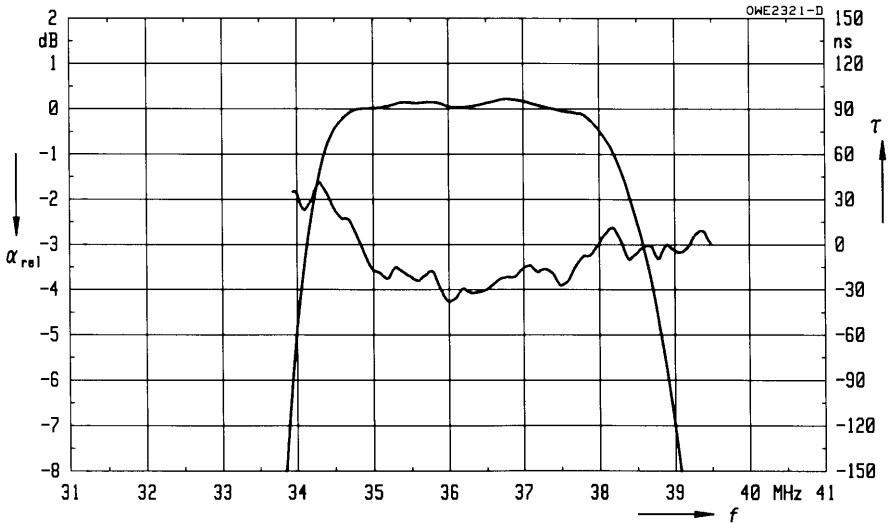
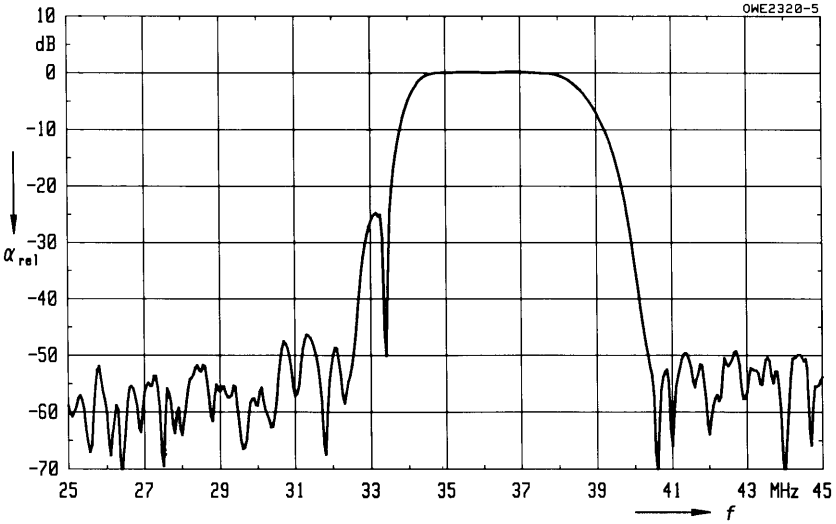

**Characteristics of sound channel**

Ambient temperature  $T_A = 25\text{ °C}$   
 Source impedance  $Z_S = 50\ \Omega$   
 Load impedance  $Z_L = 2\text{ k}\Omega \parallel 3\text{ pF}$

		min.	typ.	max.	
<b>Insertion attenuation</b>	$\alpha$				
Reference level for the following data	38,90 MHz	24,4	25,9	27,4	dB
<b>Relative attenuation</b>	$\alpha_{rel}$				
Sound carrier	32,40 MHz	-2,0	-1,0	0,0	dB
	33,40 MHz	0,0	1,0	2,0	dB
	34,40 MHz	0,0	1,0	2,0	dB
NICAM sound carrier	33,05 MHz	-2,0	-1,0	0,0	dB
Adjacent picture carrier	30,90 MHz	30,0	37,0	—	dB
Adjacent sound carrier	40,40 MHz	30,0	36,0	—	dB
Lower sidelobe	25,00 ... 30,90 MHz	28,0	34,0	—	dB
Upper sidelobe	40,40 ... 45,00 MHz	28,0	34,0	—	dB
<b>Impedance at 38,90 MHz</b>					
Output: $Z_{OUT} = R_{OUT} \parallel C_{OUT}$		—	9,8 $\parallel$ 2,0	—	k $\Omega$ $\parallel$ pF
<b>Temperature coefficient of frequency</b>	$TC_f$	—	-72	—	ppm/K

**Frequency response**

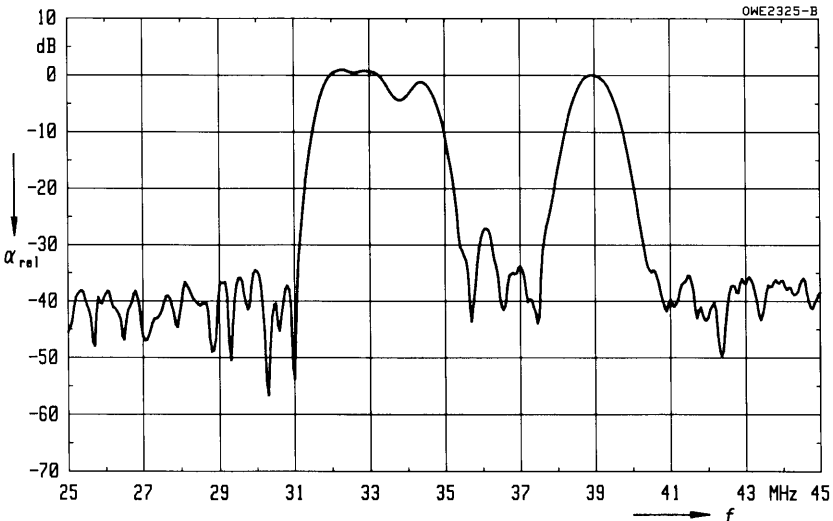

### Standard

- B/G-CCIR  
Germany, Europe partly
- D/K-OIRT  
Eastern standard

Plastic package DIP 10 K

### Features

- TV IF filter for quasi/split sound applications (separate picture and sound channel)
- Picture channel with Nyquist slope and sound suppression
- Reduced group delay predistortion as compared with standard B/G half
- Sound channel with pass band for sound carriers between 32,40 MHz and 33,40 MHz
- Suitable for CENELEC EN 55020

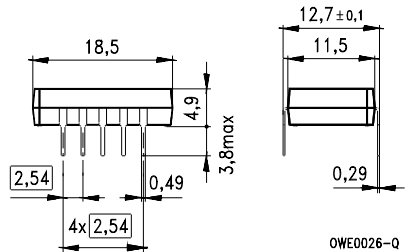
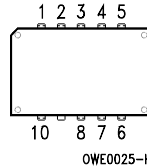

### Terminals

- Tinned CuFe alloy

Dimensions in mm, approx. weight 1,8 g

### Pin configuration

- 1 Input
- 2 Input – ground
- 3, 8 Chip carrier – ground
- 4, 5 Output – sound
- 6, 7 Output – picture
- 9 Free
- 10 Not connected

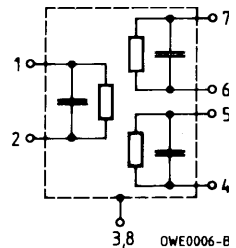

Type	Ordering code	Marking
K 3350 K	B39389-K3350-K100	Type, date code, pin 1

### Maximum ratings

Ambient temperature	$T_A$	- 25/+ 65	°C	—
Storage temperature	$T_{stg}$	- 25/+ 85	°C	—
DC voltage	$V_{DC}$	12	V	between any terminals
AC voltage	$V_{pp}$	10	V	between any terminals

**Characteristics of picture channel**

Ambient temperature  $T_A = 25\text{ °C}$   
 Source impedance  $Z_S = 50\ \Omega$   
 Load impedance  $Z_L = 2\text{ k}\Omega \parallel 3\text{ pF}$

		min.	typ.	max.	
<b>Insertion attenuation</b>					
	$\alpha$				
Reference level for the following data	37,40 MHz	13,6	15,1	16,6	dB
<b>Relative attenuation</b>					
	$\alpha_{rel}$				
Picture carrier	38,90 MHz	5,6	6,6	7,6	dB
Color carrier	34,47 MHz	0,0	1,0	2,0	dB
Sound carrier	33,40 MHz	34,0	43,0	—	dB
Adjacent picture carrier	UHF 30,90 MHz	45,0	53,0	—	dB
	VHF 31,90 MHz	47,0	57,0	—	dB
	31,40 MHz	—	60,0	—	dB
	32,40 MHz	47,0	55,0	—	dB
	40,15 MHz	43,0	59,0	—	dB
Adjacent sound carrier	VHF 40,40 MHz	45,0	56,0	—	dB
	UHF 41,40 MHz	43,0	55,0	—	dB
Lower sidelobe	25,00 ... 31,90 MHz	39,0	44,0	—	dB
Upper sidelobe	40,40 ... 45,00 MHz	34,0	40,0	—	dB
<b>Reflected wave signal suppression</b>					
1,3 $\mu$ s ... 6,0 $\mu$ s after main pulse (test pulse: 250 ns, carrier frequency: 37,40 MHz)		42,0	52,0	—	dB
<b>Feedthrough signal suppression</b>					
1,2 $\mu$ s ... 1,1 $\mu$ s before main pulse (test pulse: 250 ns, carrier frequency: 37,40 MHz)		50,0	56,0	—	dB
<b>Group delay predistortion</b>					
(reference frequency 38,90 MHz)					
	$\Delta\tau$				
	36,90 MHz	—	-90	—	ns
	34,47 MHz	—	30	—	ns
<b>Impedance at 37,40 MHz</b>					
Input:	$Z_{IN} = R_{IN} \parallel C_{IN}$	—	1,1 $\parallel$ 24,8	—	k $\Omega$ $\parallel$ pF
Output:	$Z_{OUT} = R_{OUT} \parallel C_{OUT}$	—	1,6 $\parallel$ 4,1	—	k $\Omega$ $\parallel$ pF
<b>Temperature coefficient of frequency</b>					
	$TC_f$	—	-72	—	ppm/K

**Frequency response**

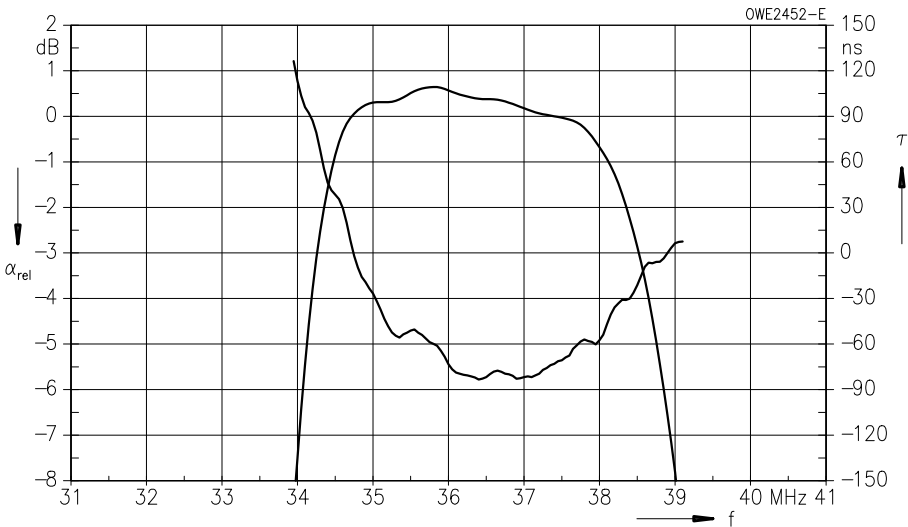
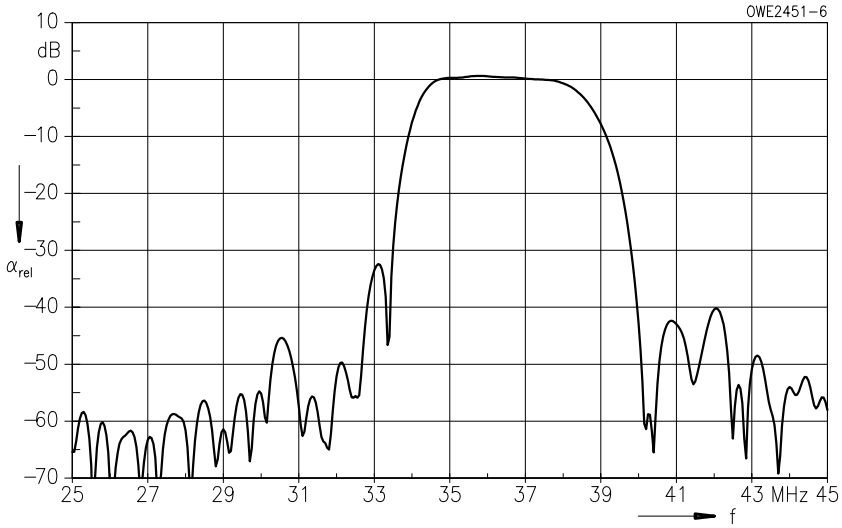

**Characteristics of sound channel**

Ambient temperature  $T_A = 25\text{ }^\circ\text{C}$   
 Source impedance  $Z_S = 50\ \Omega$   
 Load impedance  $Z_L = 2\text{ k}\Omega \parallel 3\text{ pF}$

		min.	typ.	max.	
<b>Insertion attenuation</b>					
	$\alpha$				
Reference level for the following data	33,40 MHz	14,0	15,5	17,0	dB
<b>Relative attenuation</b>					
	$\alpha_{rel}$				
Sound carrier B/G NICAM	33,05 MHz	- 1,5	- 0,5	0,5	dB
Sound carrier D/K	32,40 MHz	- 1,9	- 0,9	0,1	dB
Picture carrier	38,90 MHz	41,0	49,0	—	dB
Color carrier	34,47 MHz	28,0	34,0	—	dB
Adjacent picture carrier	30,90 MHz	36,0	43,0	—	dB
Adjacent sound carrier	40,40 MHz	44,0	52,0	—	dB
	41,40 MHz	46,0	56,0	—	dB
Lower sidelobe	25,00 ... 30,90 MHz	36,0	41,0	—	dB
Upper sidelobe	38,90 ... 45,00 MHz	41,0	48,0	—	dB
<b>Impedance at 33,40 MHz</b>					
	Output: $Z_{OUT} = R_{OUT} \parallel C_{OUT}$	—	3,6    2,3	—	k $\Omega$    pF
<b>Temperature coefficient of frequency</b>					
	$TC_f$	—	- 72	—	ppm/K

**Frequency response**

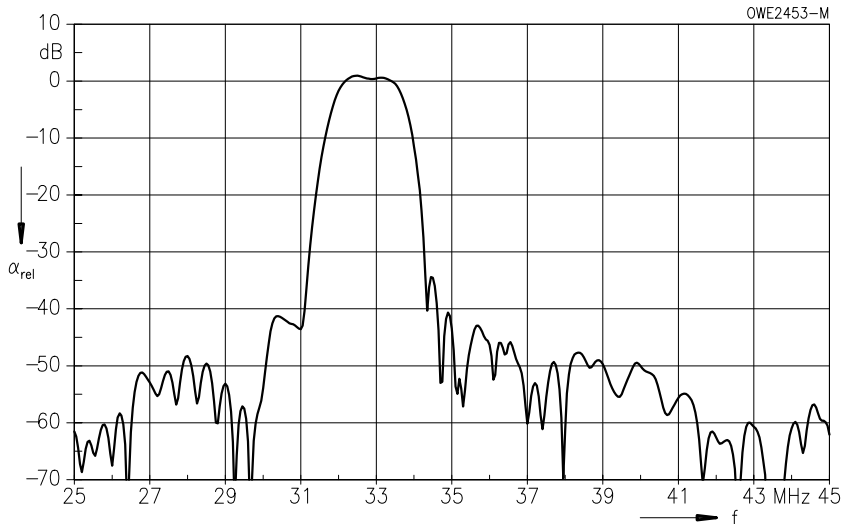

### Standard

Plastic package DIP 10 K

- I  
Great Britain

### Features

- TV IF filter for quasi/split sound applications (separate picture and sound channel)
- Picture channel with Nyquist slope and sound suppression
- Constant group delay
- Sound channel with pass bands for picture carrier and sound carriers at 33,50 MHz and 32,95 MHz (NICAM)

### Terminals

- Tinned CuFe alloy

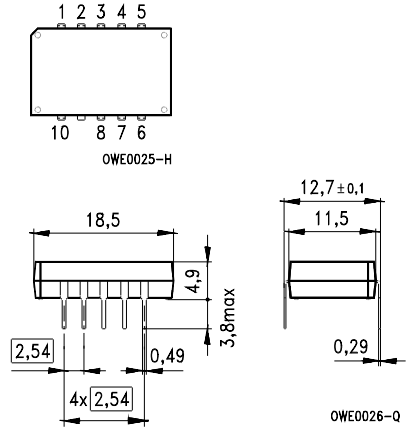

Dimensions in mm, approx. weight 1,8 g

### Pin configuration

- 1 Input
- 2 Input – ground
- 3, 8 Chip carrier – ground
- 4, 5 Output – sound
- 6, 7 Output – picture
- 9 Free
- 10 Not connected

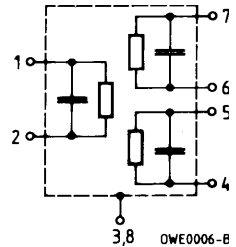

Type	Ordering code	Marking
J 3252 K	B39395-J3252-K100	Type, date code, pin 1

### Maximum ratings

Ambient temperature	$T_A$	- 25/+ 65	°C	—
Storage temperature	$T_{stg}$	- 25/+ 85	°C	—
DC voltage	$V_{DC}$	12	V	between any terminals
AC voltage	$V_{pp}$	10	V	between any terminals



**Characteristics of picture channel**

Ambient temperature  $T_A = 25\text{ }^\circ\text{C}$   
 Source impedance  $Z_S = 50\ \Omega$   
 Load impedance  $Z_L = 2\ \text{k}\Omega \parallel 3\ \text{pF}$

		min.	typ.	max.	
<b>Insertion attenuation</b>					
	$\alpha$				
Reference level for the following data	38,00 MHz	17,5	19,0	20,5	dB
<b>Relative attenuation</b>					
	$\alpha_{\text{rel}}$				
Picture carrier	39,50 MHz	4,4	5,4	6,4	dB
Color carrier	35,07 MHz	2,2	3,2	4,2	dB
Sound carrier	33,50 MHz	46,0	59,0	—	dB
	32,95 MHz	38,0	46,0	—	dB
Adjacent picture carrier	31,50 MHz	45,0	54,0	—	dB
Adjacent sound carrier	41,50 MHz	40,0	49,0	—	dB
	40,95 MHz	36,0	43,0	—	dB
Lower sidelobe	25,00 ... 33,50 MHz	38,0	45,0	—	dB
Upper sidelobe	41,50 ... 45,00 MHz	35,0	40,0	—	dB
<b>Reflected wave signal suppression</b>					
1,1 $\mu\text{s}$ ... 6,0 $\mu\text{s}$ after main pulse (test pulse: 250 ns, carrier frequency: 38,00 MHz)		44,0	55,0	—	dB
<b>Feedthrough signal suppression</b>					
1,0 $\mu\text{s}$ ... 0,9 $\mu\text{s}$ before main pulse (test pulse: 250 ns, carrier frequency: 38,00 MHz)		—	56,0	—	dB
<b>Group delay ripple (p-p)</b>	$\Delta\tau$	—	40	—	ns
<b>Impedance at 38,00 MHz</b>					
Input: $Z_{\text{IN}} = R_{\text{IN}} \parallel C_{\text{IN}}$		—	2,2 $\parallel$ 17,2	—	k $\Omega$ $\parallel$ pF
Output: $Z_{\text{OUT}} = R_{\text{OUT}} \parallel C_{\text{OUT}}$		—	1,4 $\parallel$ 4,2	—	k $\Omega$ $\parallel$ pF
<b>Temperature coefficient of frequency</b>	$TC_f$	—	-72	—	ppm/K

Frequency response

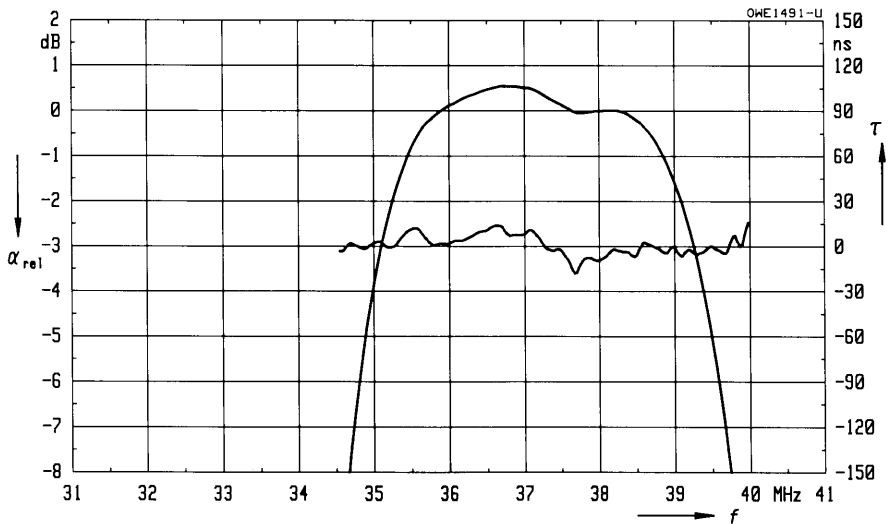
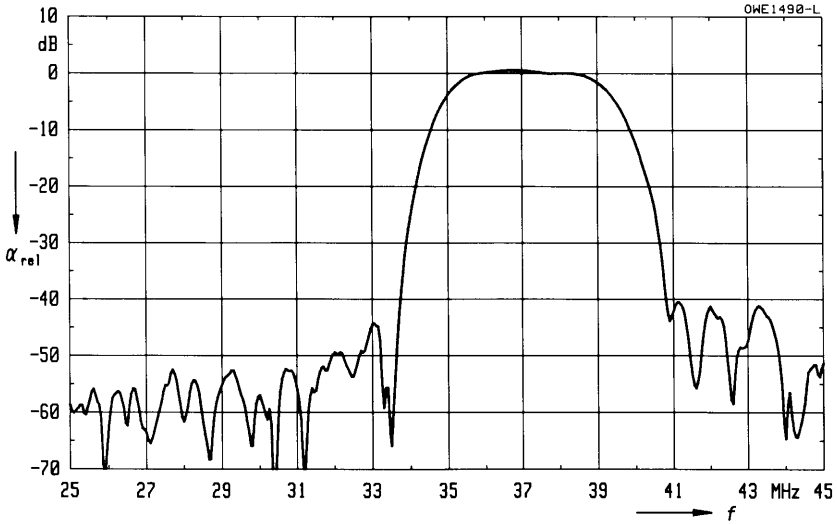

**Characteristics of sound channel**

Ambient temperature  $T_A = 25\text{ °C}$   
 Source impedance  $Z_S = 50\ \Omega$   
 Load impedance  $Z_L = 2\text{ k}\Omega \parallel 3\text{ pF}$

		min.	typ.	max.	
<b>Insertion attenuation</b>	$\alpha$				
Reference level for the following data	32,95 MHz	20,0	21,3	23,0	dB
<b>Relative attenuation</b>	$\alpha_{rel}$				
Sound carrier	33,50 MHz	- 0,1	0,9	1,9	dB
	32,55 MHz	—	0,8	—	dB
	33,35 MHz	—	0,8	—	dB
Picture carrier	39,50 MHz	- 0,6	0,4	1,4	dB
Color carrier	35,07 MHz	26,0	38,0	—	dB
Adjacent picture carrier	31,50 MHz	30,0	38,0	—	dB
Adjacent sound carrier	41,50 MHz	26,0	33,0	—	dB
Lower sidelobe	25,00 ... 31,50 MHz	30,0	36,0	—	dB
Upper sidelobe	41,50 ... 45,00 MHz	25,0	33,0	—	dB
<b>Impedance at 32,95 MHz</b>					
Output: $Z_{OUT} = R_{OUT} \parallel C_{OUT}$		—	4,4    3,8	—	k $\Omega$    pF
<b>Temperature coefficient of frequency</b>	$TC_f$	—	- 72	—	ppm/K

**Frequency response**

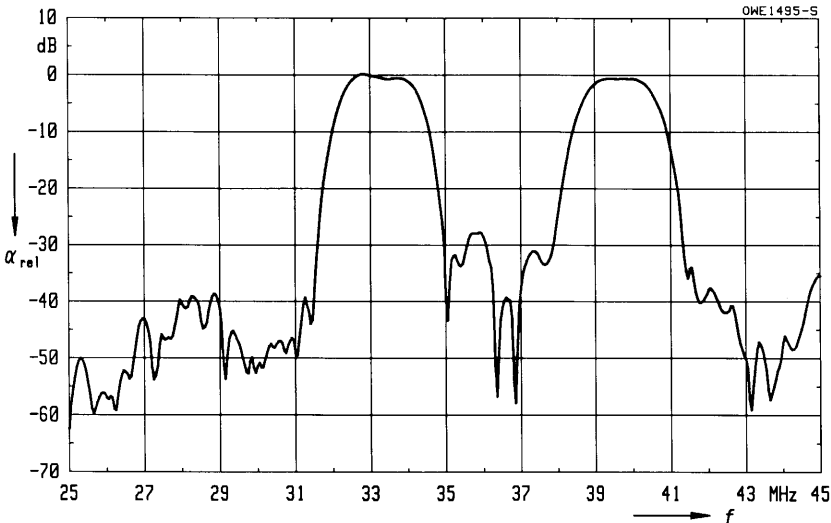

## Standard

Plastic package DIP 10 K

- I  
Great Britain

## Features

- TV IF filter for quasi/split sound applications (separate picture and sound channel)
- Picture channel with Nyquist slope and sound suppression
- Constant group delay
- Sound channel with pass band for sound carriers at 33,50 MHz and 32,95 MHz (NICAM)
- Suitable for CENELEC EN 55020

## Terminals

- Tinned CuFe alloy

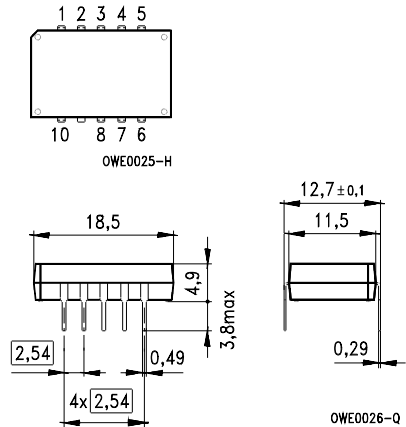

Dimensions in mm, approx. weight 1,8 g

## Pin configuration

- 1 Input
- 2 Input – ground
- 3, 8 Chip carrier – ground
- 4, 5 Output – sound
- 6, 7 Output – picture
- 9 Free
- 10 Not connected

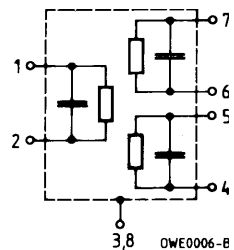

Type	Ordering code	Marking
J 3352 K	B39395-J3352-K100	Type, date code, pin 1

## Maximum ratings

Ambient temperature	$T_A$	- 25/+ 65	°C	—
Storage temperature	$T_{stg}$	- 25/+ 85	°C	—
DC voltage	$V_{DC}$	12	V	between any terminals
AC voltage	$V_{pp}$	10	V	between any terminals

**Characteristics of picture channel**

Ambient temperature  $T_A = 25\text{ °C}$   
 Source impedance  $Z_S = 50\ \Omega$   
 Load impedance  $Z_L = 2\text{ k}\Omega \parallel 3\text{ pF}$

		min.	typ.	max.	
<b>Insertion attenuation</b>					
	$\alpha$				
Reference level for the following data	38,00 MHz	14,3	15,8	17,3	dB
<b>Relative attenuation</b>					
	$\alpha_{rel}$				
Picture carrier	39,50 MHz	5,3	6,3	7,3	dB
Color carrier	35,07 MHz	- 0,7	0,3	1,3	dB
Sound carrier	33,50 MHz	40,0	55,0	—	dB
	32,95 MHz	40,0	51,0	—	dB
Adjacent picture carrier	31,50 MHz	48,0	60,0	—	dB
	31,00 MHz	48,0	62,0	—	dB
	32,00 MHz	50,0	60,0	—	dB
Adjacent sound carrier	41,50 MHz	46,0	59,0	—	dB
	40,95 MHz	42,0	52,0	—	dB
Lower sidelobe	25,00 ... 31,50 MHz	44,0	52,0	—	dB
Upper sidelobe	41,50 ... 45,00 MHz	40,0	46,0	—	dB
<b>Reflected wave signal suppression</b>					
1,2 $\mu$ s ... 6,0 $\mu$ s after main pulse (test pulse: 250 ns, carrier frequency: 38,00 MHz)		42,0	54,0	—	dB
<b>Feedthrough signal suppression</b>					
1,3 $\mu$ s ... 1,2 $\mu$ s before main pulse (test pulse: 250 ns, carrier frequency: 38,00 MHz)		—	56,0	—	dB
<b>Group delay ripple (p-p)</b>					
	$\Delta\tau$	—	30	—	ns
<b>Impedance at 38,00 MHz</b>					
	Input: $Z_{IN} = R_{IN} \parallel C_{IN}$	—	1,0 $\parallel$ 28,3	—	k $\Omega$ $\parallel$ pF
	Output: $Z_{OUT} = R_{OUT} \parallel C_{OUT}$	—	2,7 $\parallel$ 3,3	—	k $\Omega$ $\parallel$ pF
<b>Temperature coefficient of frequency</b>					
	$TC_f$	—	- 72	—	ppm/K

**Frequency response**

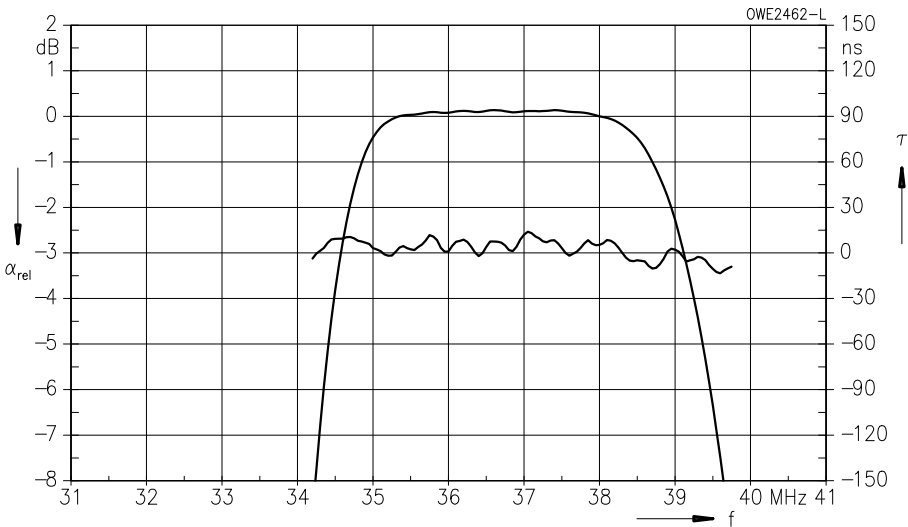
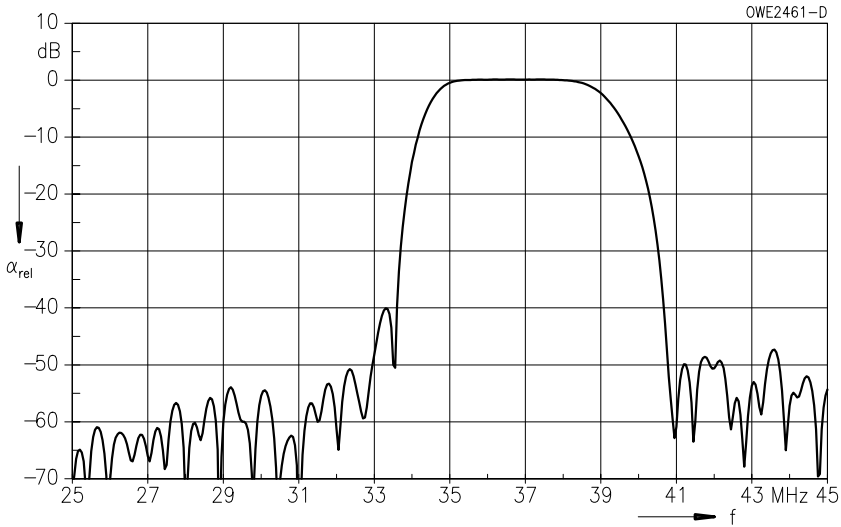

**Characteristics of sound channel**

Ambient temperature  $T_A = 25\text{ °C}$   
 Source impedance  $Z_S = 50\ \Omega$   
 Load impedance  $Z_L = 2\text{ k}\Omega \parallel 3\text{ pF}$

		min.	typ.	max.	
<b>Insertion attenuation</b>	$\alpha$				
Reference level for the following data	32,95 MHz	10,1	11,6	13,1	dB
<b>Relative attenuation</b>	$\alpha_{rel}$				
Sound carrier	33,50 MHz	- 0,7	0,3	1,3	dB
Picture carrier	39,50 MHz	46,0	60,0	—	dB
Color carrier	35,07 MHz	30,0	45,0	—	dB
Adjacent picture carrier	31,50 MHz	40,0	52,0	—	dB
Adjacent sound carrier	41,50 MHz	50,0	62,0	—	dB
	40,95 MHz	45,0	56,0	—	dB
Lower sidelobe	25,00 ... 31,50 MHz	36,0	42,0	—	dB
Upper sidelobe	39,50 ... 45,00 MHz	44,0	52,0	—	dB
<b>Impedance at 32,95 MHz</b>					
Output: $Z_{OUT} = R_{OUT} \parallel C_{OUT}$		—	2,6 $\parallel$ 3,3	—	k $\Omega$ $\parallel$ pF
<b>Temperature coefficient of frequency</b>	$TC_f$	—	- 72	—	ppm/K

**Frequency response**

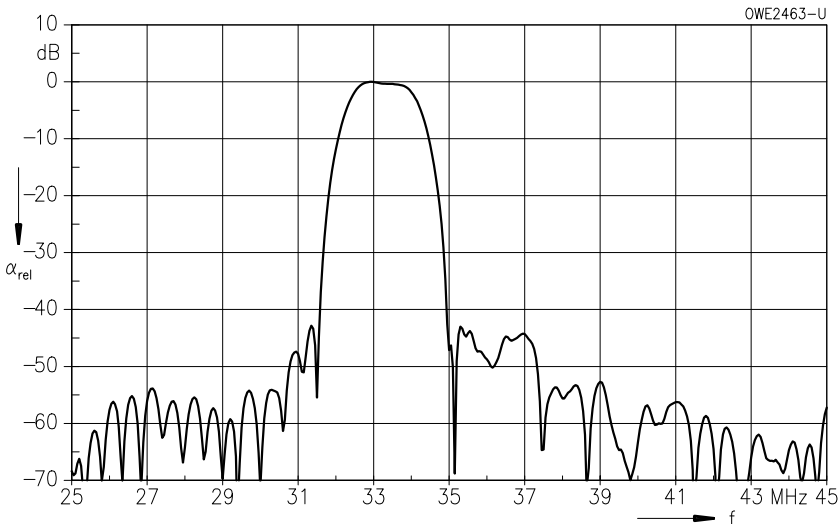

### Standard

- M/N-FCC  
USA

Plastic package **DIP 10 K**

### Features

- TV IF filter for quasi/split sound applications (separate picture and sound channel)
- Picture channel with Nyquist slope and sound suppression
- Constant group delay
- Sound channel with pass bands for picture carrier and sound carrier
- Phase shift between picture and sound channel optimized for twin PLL ICs
- Suitable for FCC EIA/IS-31 regulations

### Terminals

- Tinned CuFe alloy

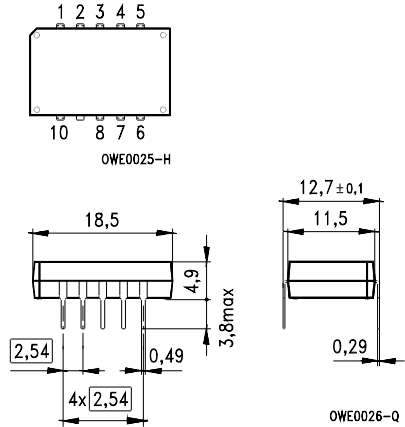

Dimensions in mm, approx. weight 1,8 g

### Pin configuration

- 1 Input
- 2 Input – ground
- 3, 8 Chip carrier – ground
- 4, 5 Output – sound
- 6, 7 Output – picture
- 9 Free
- 10 Not connected

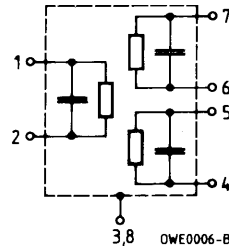

Type	Ordering code	Marking
M 3271 K	B39458-M3271-K100	Type, date code, pin 1

### Maximum ratings

Ambient temperature	$T_A$	- 25/+ 65	°C	—
Storage temperature	$T_{stg}$	- 25/+ 85	°C	—
DC voltage	$V_{DC}$	12	V	between any terminals
AC voltage	$V_{pp}$	10	V	between any terminals



**Characteristics of picture channel**

Ambient temperature  $T_A = 25 (45)^\circ\text{C}$   
 Source impedance  $Z_S = 50 \Omega$   
 Load impedance  $Z_L = 2 \text{ k}\Omega \parallel 3 \text{ pF}$

		min.	typ.	max.	
<b>Insertion attenuation</b>					$\alpha$
Reference level for the following data	44,06 (44,00) MHz	12,4	13,9	15,4	dB
<b>Relative attenuation</b>					$\alpha_{\text{rel}}$
Picture carrier	45,81 (45,75) MHz	5,6	6,6	7,6	dB
Color carrier	42,23 (42,17) MHz	- 0,9	0,1	1,1	dB
	41,73 (41,67) MHz	3,9	5,4	6,9	dB
Sound carrier	41,31 (41,25) MHz	20,0	29,0	—	dB
Adjacent picture carrier	39,81 (39,75) MHz	46,0	54,0	—	dB
Adjacent sound carrier	47,31 (47,25) MHz	44,0	58,0	—	dB
Lower sidelobe					
	35,06 ... 39,81 (35,00 ... 39,75) MHz	40,0	46,0	—	dB
Upper sidelobe					
	47,31 ... 55,06 (47,25 ... 55,00) MHz	37,0	43,0	—	dB
<b>Reflected wave signal suppression</b>					
1,2 $\mu\text{s}$ ... 6,0 $\mu\text{s}$ after main pulse (test pulse: 250 ns, carrier frequency: 44,06 MHz)		42,0	50,0	—	dB
<b>Feedthrough signal suppression</b>					
1,3 $\mu\text{s}$ ... 1,2 $\mu\text{s}$ before main pulse (test pulse: 250 ns, carrier frequency: 44,06 MHz)		—	56,0	—	dB
<b>Phase difference</b> referred to sound channel at 45,81 (45,75) MHz		$\Delta\varphi$			
		55,0	60,0	65,0	$^\circ$
<b>Group delay ripple</b> (p-p)		$\Delta\tau$			
		—	60	—	ns
<b>Impedance</b> at 44,06 MHz					
	Input: $Z_{\text{IN}} = R_{\text{IN}} \parallel C_{\text{IN}}$	—	0,9 $\parallel$ 25,0	—	k $\Omega$ $\parallel$ pF
	Output: $Z_{\text{OUT}} = R_{\text{OUT}} \parallel C_{\text{OUT}}$	—	1,0 $\parallel$ 3,7	—	k $\Omega$ $\parallel$ pF
<b>Temperature coefficient of frequency</b>		$TC_f$			
		—	- 72	—	ppm/K

**M 3271 K**  
**45,75 MHz**

**Frequency response**

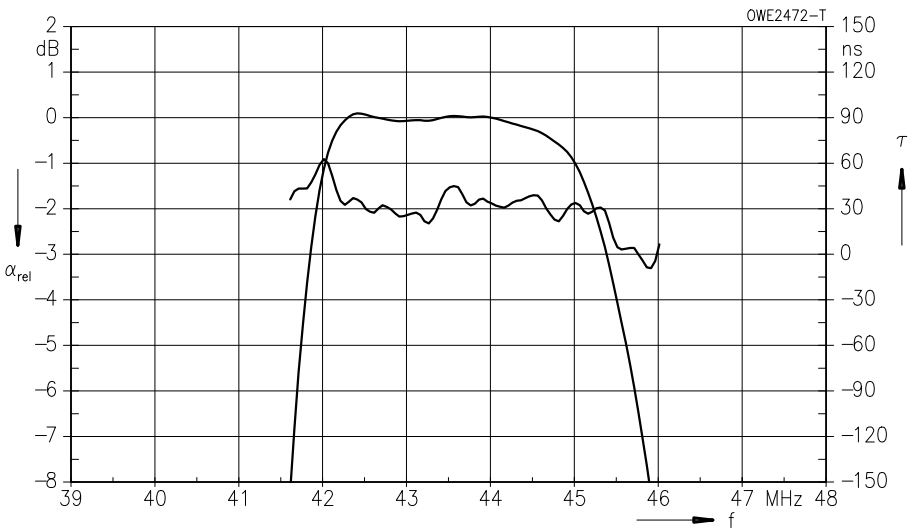
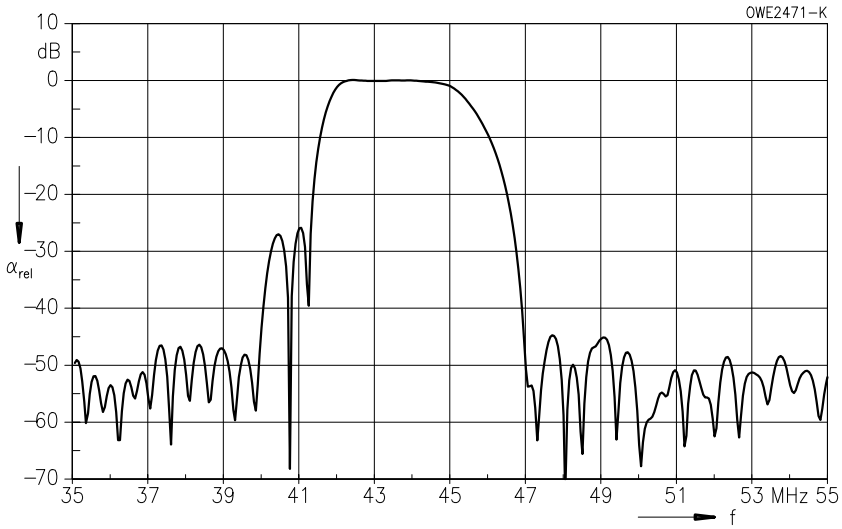

**Characteristics of sound channel**

Ambient temperature  $T_A = 25 (45) \text{ }^\circ\text{C}$   
 Source impedance  $Z_S = 50 \text{ } \Omega$   
 Load impedance  $Z_L = 2 \text{ k}\Omega \parallel 3 \text{ pF}$

		min.	typ.	max.	
<b>Insertion attenuation</b> $\alpha$					
Reference level for the following data	45,81 (45,75) MHz	17,6	19,1	20,6	dB
<b>Relative attenuation</b> $\alpha_{rel}$					
Sound carrier	41,31 (41,25) MHz	- 2,6	- 1,1	0,4	dB
Color carrier	42,23 (42,17) MHz	22,0	31,0	—	dB
Adjacent picture carrier	39,81 (39,75) MHz	40,0	54,0	—	dB
Adjacent sound carrier	47,31 (47,25) MHz	36,0	46,0	—	dB
Lower sidelobe					
	35,06 ... 39,81 (35,00 ... 39,75) MHz	36,0	43,0	—	dB
Upper sidelobe					
	47,31 ... 55,06 (47,25 ... 55,00) MHz	32,0	38,0	—	dB
<b>Impedance at 45,81 MHz</b>					
	Output: $Z_{OUT} = R_{OUT} \parallel C_{OUT}$	—	5,3 $\parallel$ 1,7	—	k $\Omega$ $\parallel$ pF
<b>Temperature coefficient of frequency</b> $TC_f$		—	- 72	—	ppm/K

**Frequency response**

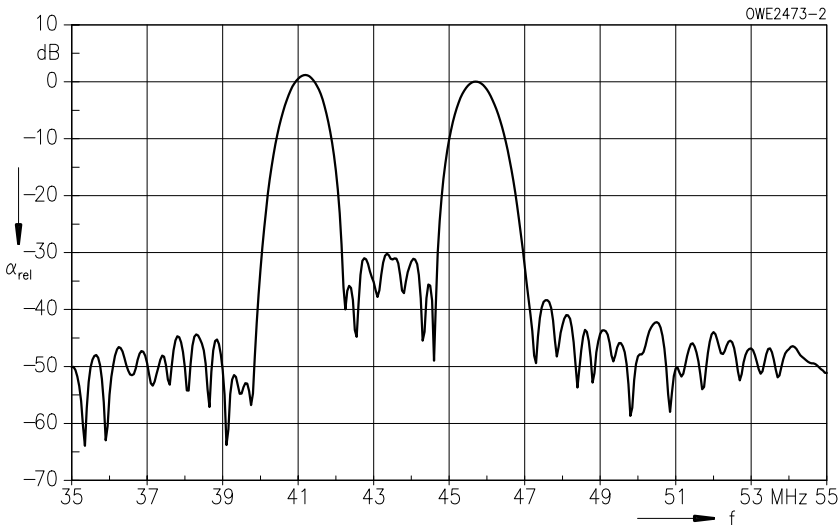

### Standard

Plastic package DIP 10 K

- M/N-FCC  
USA

### Features

- TV IF filter for quasi/split sound applications (separate picture and sound channel)
- Picture channel with Nyquist slope and sound suppression
- Constant group delay
- Sound channel with pass band for sound carrier
- Suitable for FCC EIA/IS-31 regulations

### Terminals

- Tinned CuFe alloy

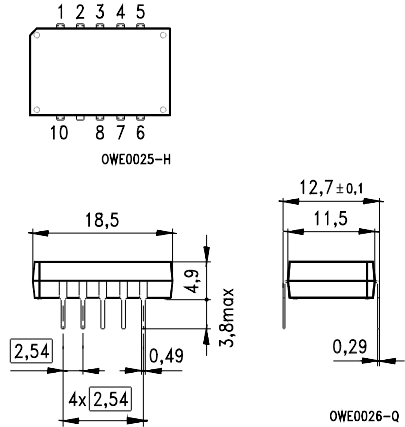

Dimensions in mm, approx. weight 1,8 g

### Pin configuration

- 1 Input
- 2 Input – ground
- 3, 8 Chip carrier – ground
- 4, 5 Output – sound
- 6, 7 Output – picture
- 9 Free
- 10 Not connected

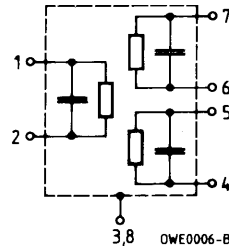

Type	Ordering code	Marking
M 3354 K	B39458-M3354-K100	Type, date code, pin 1

### Maximum ratings

Ambient temperature	$T_A$	- 25/+ 65	°C	—
Storage temperature	$T_{stg}$	- 25/+ 85	°C	—
DC voltage	$V_{DC}$	12	V	between any terminals
AC voltage	$V_{pp}$	10	V	between any terminals

**Characteristics of picture channel**

Ambient temperature  $T_A = 25 (45) \text{ }^\circ\text{C}$   
 Source impedance  $Z_S = 50 \text{ } \Omega$   
 Load impedance  $Z_L = 2 \text{ k}\Omega \parallel 3 \text{ pF}$

		min.	typ.	max.	
<b>Insertion attenuation</b> $\alpha$					
Reference level for the following data	44,06 (44,00) MHz	13,5	15,0	16,5	dB
<b>Relative attenuation</b> $\alpha_{rel}$					
Picture carrier	45,81 (45,75) MHz	4,6	5,6	6,6	dB
Color carrier	42,23 (42,17) MHz	- 1,4	- 0,4	0,6	dB
	41,73 (41,67) MHz	4,5	5,5	6,5	dB
Sound carrier	41,31 (41,25) MHz	25,0	32,0	—	dB
Adjacent picture carrier	39,81 (39,75) MHz	46,0	56,0	—	dB
Adjacent sound carrier	47,31 (47,25) MHz	44,0	51,0	—	dB
Lower sidelobe					
	35,06 ... 39,81 (35,00 ... 39,75) MHz	35,0	40,0	—	dB
Upper sidelobe					
	47,31 ... 55,06 (47,25 ... 55,00) MHz	38,0	44,0	—	dB
<b>Reflected wave signal suppression</b>					
1,2 $\mu\text{s}$ ... 6,0 $\mu\text{s}$ after main pulse (test pulse: 250 ns, carrier frequency: 44,06 MHz)		42,0	52,0	—	dB
<b>Feedthrough signal suppression</b>					
1,3 $\mu\text{s}$ ... 1,2 $\mu\text{s}$ before main pulse (test pulse: 250 ns, carrier frequency: 44,06 MHz)		—	56,0	—	dB
<b>Group delay ripple (p-p)</b> $\Delta\tau$		—	50	—	ns
<b>Impedance at 44,06 MHz</b>					
Input: $Z_{IN} = R_{IN} \parallel C_{IN}$		—	1,3 $\parallel$ 19,7	—	k $\Omega$ $\parallel$ pF
Output: $Z_{OUT} = R_{OUT} \parallel C_{OUT}$		—	1,0 $\parallel$ 3,9	—	k $\Omega$ $\parallel$ pF
<b>Temperature coefficient of frequency</b> $TC_f$		—	- 72	—	ppm/K

**M 3354 K**  
**45,75 MHz**

**Frequency response**

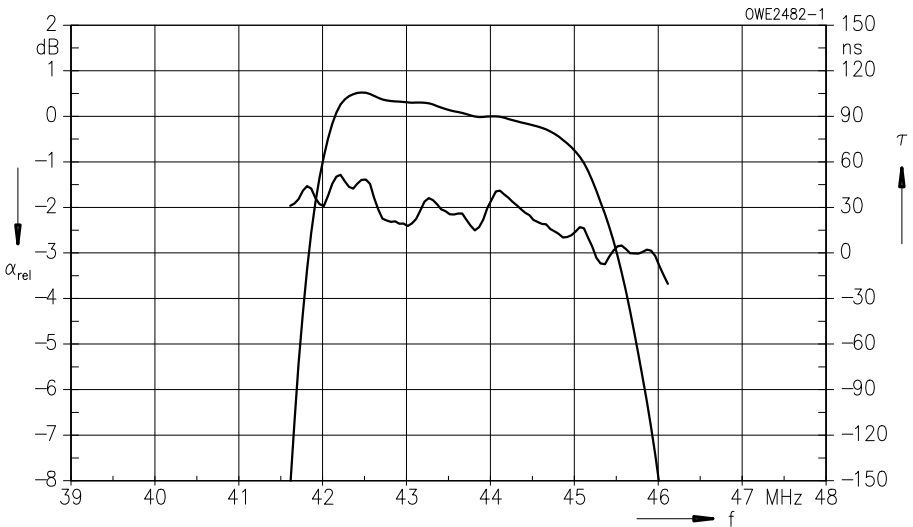
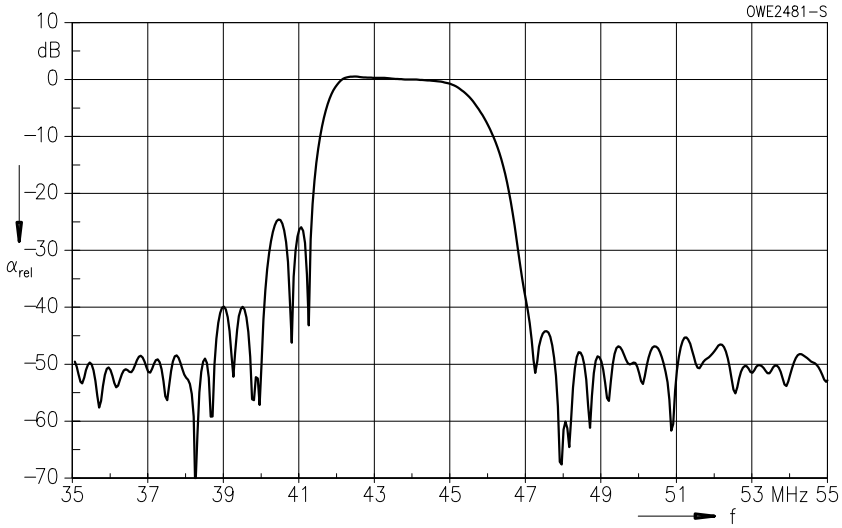

**Characteristics of sound channel**

Ambient temperature  $T_A = 25 (45) \text{ }^\circ\text{C}$   
 Source impedance  $Z_S = 50 \text{ } \Omega$   
 Load impedance  $Z_L = 2 \text{ k}\Omega \parallel 3 \text{ pF}$

		min.	typ.	max.	
<b>Insertion attenuation</b> $\alpha$					
Reference level for the following data	41,31 (41,25) MHz	12,3	13,8	15,3	dB
<b>Relative attenuation</b> $\alpha_{rel}$					
Picture carrier	45,81 (45,75) MHz	42,0	53,0	—	dB
Color carrier	42,23 (42,17) MHz	25,0	33,0	—	dB
Adjacent picture carrier	39,81 (39,75) MHz	40,0	47,0	—	dB
Adjacent sound carrier	47,31 (47,25) MHz	40,0	47,0	—	dB
Lower sidelobe					
	35,06 ... 39,81 (35,00 ... 39,75) MHz	30,0	34,0	—	dB
Upper sidelobe					
	47,31 ... 55,06 (47,25 ... 55,00) MHz	38,0	45,0	—	dB
<b>Impedance at 41,31 MHz</b>					
	Output: $Z_{OUT} = R_{OUT} \parallel C_{OUT}$	—	2,0 $\parallel$ 2,8	—	k $\Omega$ $\parallel$ pF
<b>Temperature coefficient of frequency</b> $TC_f$		—	-72	—	ppm/K

**Frequency response**

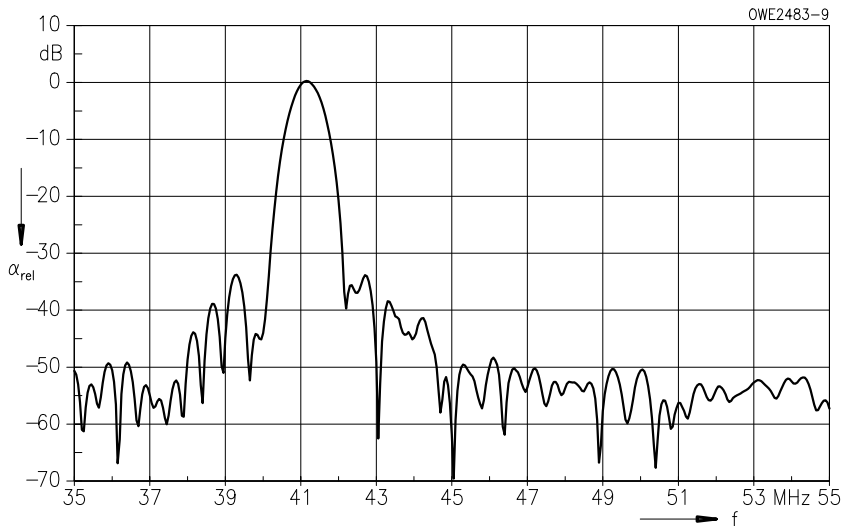

### Standard

- M/N-FCC  
USA

### Features

- TV IF filter for quasi/split sound applications (separate picture and sound channel)
- Picture channel with Nyquist slope and sound suppression, symmetrical output
- Constant group delay
- Sound channel with pass bands for sound carrier

### Terminals

- Tinned CuFe alloy

Plastic package **SIP 5 K**

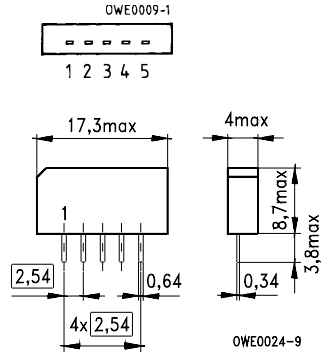

Dimensions in mm, approx. weight 1,0 g

### Pin configuration

- 1 Input
- 2 Chip carrier – ground
- 3 Output – sound
- 4 Output – picture
- 5 Output – picture

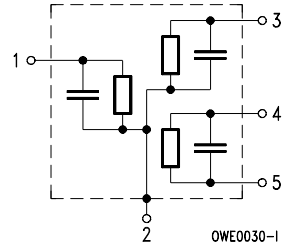

Type	Ordering code	Marking
M 3561 M	B39458-M3561-M201	Type, date code, pin 1

### Maximum ratings

Ambient temperature	$T_A$	- 25/+ 65	°C	—
Storage temperature	$T_{stg}$	- 25/+ 85	°C	—
DC voltage	$V_{DC}$	12	V	between any terminals
AC voltage	$V_{pp}$	10	V	between any terminals



**Characteristics of picture channel**

Ambient temperature  $T_A = 25 (45) \text{ }^\circ\text{C}$   
 Source impedance  $Z_S = 50 \text{ } \Omega$   
 Load impedance  $Z_L = 2 \text{ k}\Omega \parallel 3 \text{ pF}$

		min.	typ.	max.	
<b>Insertion attenuation</b> $\alpha$					
Reference level for the following data	44,06 (44,00) MHz	12,2	13,7	15,2	dB
<b>Relative attenuation</b> $\alpha_{rel}$					
Picture carrier	45,81 (45,75) MHz	4,9	5,9	6,9	dB
Color carrier	42,23 (42,17) MHz	1,2	2,2	3,2	dB
Sound carrier	41,31 (41,25) MHz	28,0	34,0	—	dB
Adjacent picture carrier	39,81 (39,75) MHz	46,0	59,0	—	dB
Adjacent sound carrier	47,31 (47,25) MHz	42,0	54,0	—	dB
Lower sidelobe					
	35,06 ... 39,81 (35,00 ... 39,75) MHz	43,0	51,0	—	dB
Upper sidelobe					
	47,31 ... 55,06 (47,25 ... 55,00) MHz	38,0	44,0	—	dB
<b>Reflected wave signal suppression</b>					
1,2 $\mu\text{s}$ ... 6,0 $\mu\text{s}$ after main pulse (test pulse: 250 ns, carrier frequency: 44,06 MHz)		42,0	54,0	—	dB
<b>Feedthrough signal suppression</b>					
1,3 $\mu\text{s}$ ... 1,2 $\mu\text{s}$ before main pulse (test pulse: 250 ns, carrier frequency: 44,06 MHz)		—	56,0	—	dB
<b>Group delay ripple</b> (p-p)	$\Delta\tau$	—	50	—	ns
<b>Impedance at 44,06 MHz</b>					
Input: $Z_{IN} = R_{IN} \parallel C_{IN}$		—	1,0 $\parallel$ 20,2	—	k $\Omega$ $\parallel$ pF
Output: $Z_{OUT} = R_{OUT} \parallel C_{OUT}$		—	1,0 $\parallel$ 4,1	—	k $\Omega$ $\parallel$ pF
<b>Temperature coefficient of frequency</b>	$TC_f$	—	-72	—	ppm/K

**M 3561 M**  
**45,75 MHz**

**Frequency response**

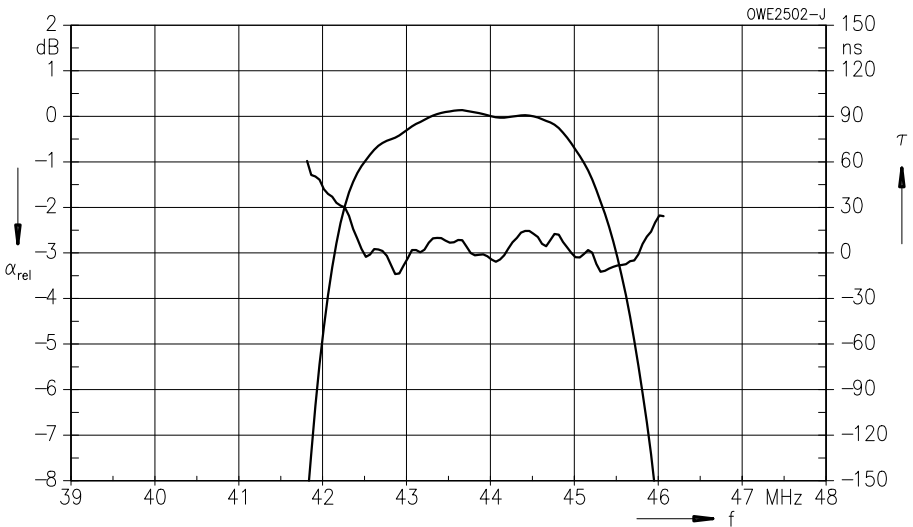
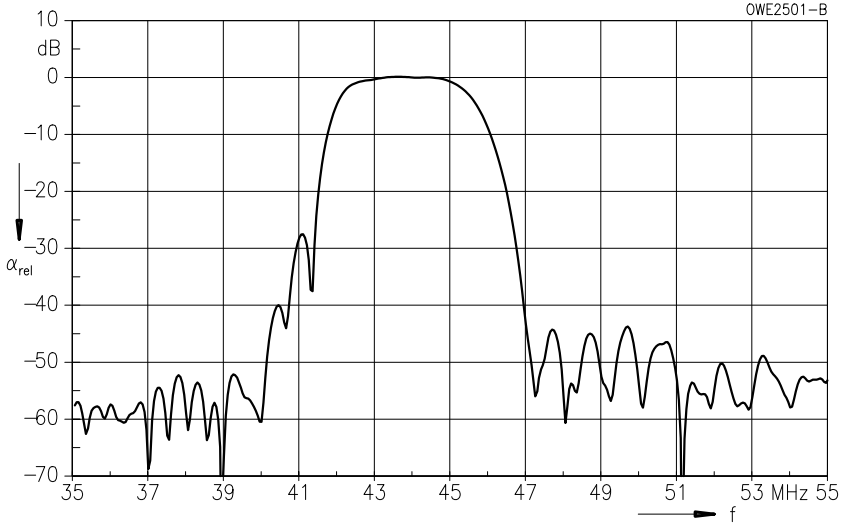

**Characteristics of sound channel**

Ambient temperature  $T_A = 25 (45) \text{ }^\circ\text{C}$   
 Source impedance  $Z_S = 50 \text{ } \Omega$   
 Load impedance  $Z_L = 2 \text{ k}\Omega \parallel 3 \text{ pF}$

		min.	typ.	max.	
<b>Insertion attenuation</b> $\alpha$					
Reference level for the following data	41,31 (41,25) MHz	14,6	16,1	17,6	dB
<b>Relative attenuation</b> $\alpha_{rel}$					
Picture carrier	45,81 (45,75) MHz	33,0	43,0	—	dB
Color carrier	42,23 (42,17) MHz	16,0	21,0	—	dB
Adjacent picture carrier	39,81 (39,75) MHz	27,0	33,0	—	dB
Adjacent sound carrier	47,31 (47,25) MHz	33,0	43,0	—	dB
Lower sidelobe					
	35,06 ... 39,81 (35,00 ... 39,75) MHz	23,0	28,0	—	dB
Upper sidelobe					
	47,31 ... 55,06 (47,25 ... 55,00) MHz	30,0	35,0	—	dB
<b>Impedance at 41,31 MHz</b>					
	Output: $Z_{OUT} = R_{OUT} \parallel C_{OUT}$	—	2,1 $\parallel$ 5,3	—	k $\Omega$ $\parallel$ pF
<b>Temperature coefficient of frequency</b> $TC_f$		—	-72	—	ppm/K

**Frequency response**

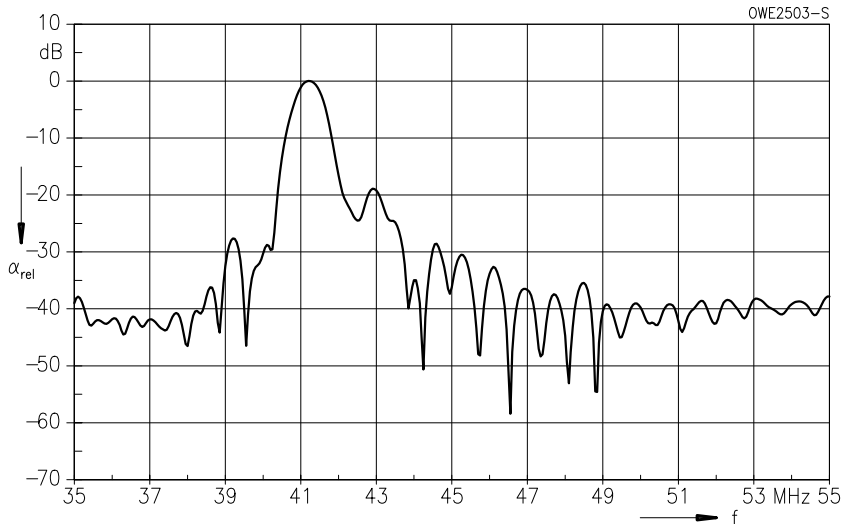

### Standard

- M/N-FCC  
USA

Plastic package **DIP 10 K**

### Features

- TV IF filter for quasi/split sound applications (separate picture and sound channel)
- Picture channel with Nyquist slope and sound suppression
- High color carrier level
- Customized group delay predistortion
- Sound channel with pass band for sound carrier
- Suitable for FCC EIA/IS-31 regulations

### Terminals

- Tinned CuFe alloy

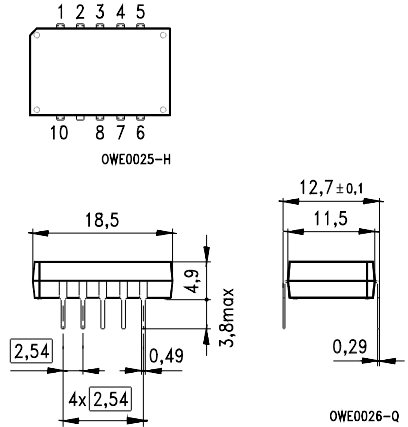

Dimensions in mm, approx. weight 1,8 g

### Pin configuration

- 1 Input
- 2 Input – ground
- 3, 8 Chip carrier – ground
- 4, 5 Output – sound
- 6, 7 Output – picture
- 9 Free
- 10 Input – picture

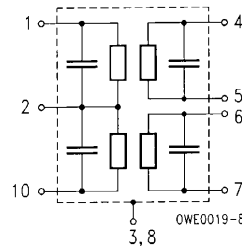

Type	Ordering code	Marking
M 3654 K	B39458-M3654-K100	Type, date code, pin 1

### Maximum ratings

Ambient temperature	$T_A$	- 25/+ 65	°C	—
Storage temperature	$T_{stg}$	- 25/+ 85	°C	—
DC voltage	$V_{DC}$	12	V	between any terminals
AC voltage	$V_{pp}$	10	V	between any terminals

**Characteristics of picture channel**

Ambient temperature  $T_A = 25 (45) \text{ }^\circ\text{C}$   
 Source impedance  $Z_S = 50 \text{ } \Omega$   
 Load impedance  $Z_L = 2 \text{ k}\Omega \parallel 3 \text{ pF}$

		min.	typ.	max.	
<b>Insertion attenuation</b> $\alpha$					
Reference level for the following data	44,06 (44,00) MHz	12,3	13,8	15,3	dB
<b>Relative attenuation</b> $\alpha_{rel}$					
Picture carrier	45,81 (45,75) MHz	5,3	6,0	6,7	dB
Color carrier	42,23 (42,17) MHz	- 0,5	0,5	1,5	dB
Sound carrier	41,31 (41,25) MHz	25,0	39,0	—	dB
Adjacent picture carrier	39,81 (39,75) MHz	45,0	56,0	—	dB
Adjacent sound carrier	47,31 (47,25) MHz	44,0	51,0	—	dB
Lower sidelobe					
	35,06 ... 39,81 (35,00 ... 39,75) MHz	37,0	41,0	—	dB
Upper sidelobe					
	47,31 ... 55,06 (47,25 ... 55,00) MHz	37,0	52,0	—	dB
<b>Reflected wave signal suppression</b>					
1,2 $\mu$ s ... 6,0 $\mu$ s after main pulse (test pulse: 250 ns, carrier frequency: 44,06 MHz)		42,0	42,0	—	dB
<b>Feedthrough signal suppression</b>					
1,2 $\mu$ s ... 1,1 $\mu$ s before main pulse (test pulse: 250 ns, carrier frequency: 44,06 MHz)		50,0	56,0	—	dB
<b>Group delay predistortion</b> $\Delta\tau$					
(reference frequency 45,81 MHz)					
	42,23 (42,17) MHz	—	- 40	—	ns
<b>Impedance at 44,06 MHz</b>					
Input: $Z_{IN} = R_{IN} \parallel C_{IN}$		—	1,2 $\parallel$ 12,4	—	k $\Omega$ $\parallel$ pF
Output: $Z_{OUT} = R_{OUT} \parallel C_{OUT}$		—	1,2 $\parallel$ 3,5	—	k $\Omega$ $\parallel$ pF
<b>Temperature coefficient of frequency</b> $TC_f$					
		—	- 72	—	ppm/K

**M 3654 K**  
**45,75 MHz**

**Frequency response**

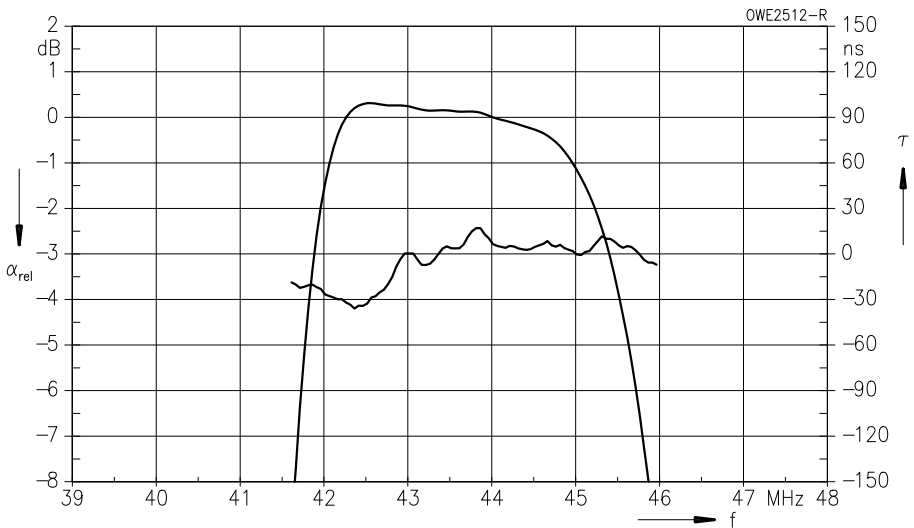
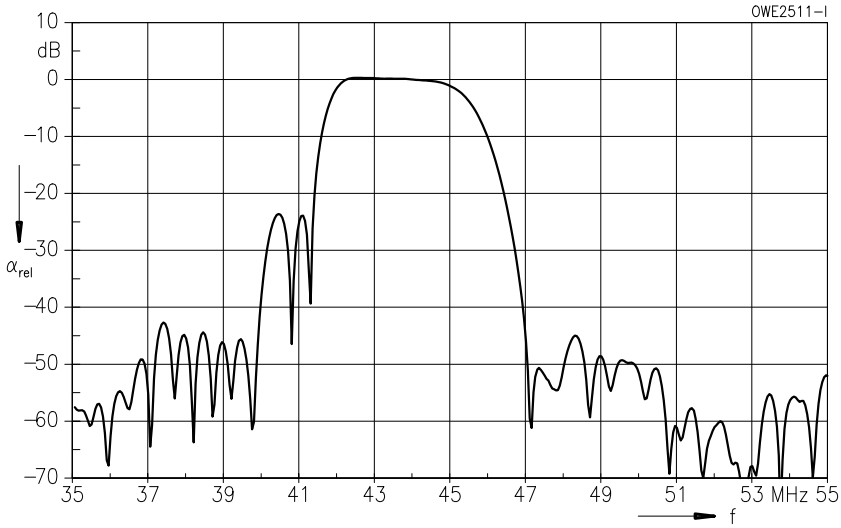

**Characteristics of sound channel**

Ambient temperature  $T_A = 25 (45) \text{ }^\circ\text{C}$   
 Source impedance  $Z_S = 50 \text{ } \Omega$   
 Load impedance  $Z_L = 2 \text{ k}\Omega \parallel 3 \text{ pF}$

		min.	typ.	max.	
<b>Insertion attenuation</b>					
Reference level for the following data	41,31 (41,25) MHz	10,5	12,0	13,5	dB
<b>Pass bandwidth</b>					
$\alpha_{\text{rel}} \leq 3 \text{ dB}$	$B_{3\text{dB}}$	—	0,6	—	MHz
$\alpha_{\text{rel}} \leq 20 \text{ dB}$	$B_{20\text{dB}}$	—	1,35	—	MHz
<b>Relative attenuation</b>					
Picture carrier	45,81 (45,75) MHz	45,0	55,0	—	dB
Color carrier	42,23 (42,17) MHz	22,0	26,0	—	dB
Adjacent picture carrier	39,81 (39,75) MHz	40,0	47,0	—	dB
Adjacent sound carrier	47,31 (47,25) MHz	43,0	52,0	—	dB
Lower sidelobe					
	35,06 ... 39,06 (35,00 ... 39,00) MHz	34,0	38,0	—	dB
	39,06 ... 39,41 (39,00 ... 39,35) MHz	36,0	42,0	—	dB
Upper sidelobe					
	47,31 ... 55,06 (47,25 ... 55,00) MHz	42,0	48,0	—	dB
<b>Group delay ripple (p-p)</b>					
	41,01 ... 41,61 (40,95 ... 41,55) MHz	—	80	—	ns
<b>Impedance at 41,31 MHz</b>					
Input:	$Z_{\text{IN}} = R_{\text{IN}} \parallel C_{\text{IN}}$	—	0,6 $\parallel$ 14,2	—	k $\Omega$ $\parallel$ pF
Output:	$Z_{\text{OUT}} = R_{\text{OUT}} \parallel C_{\text{OUT}}$	—	2,8 $\parallel$ 2,4	—	k $\Omega$ $\parallel$ pF
<b>Temperature coefficient of frequency</b>					
	$TC_f$	—	- 72	—	ppm/K

**M 3654 K**  
**45,75 MHz**

**Frequency response**

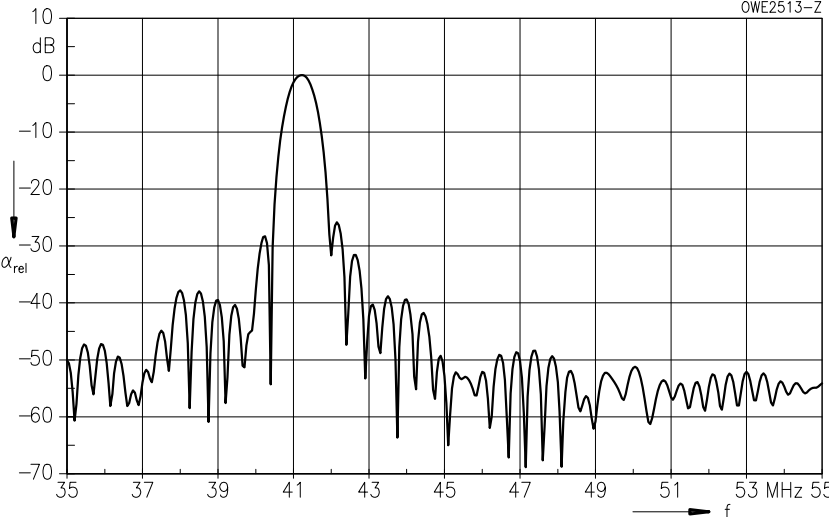



### Standard

- M  
Japan

### Features

- TV IF filter for quasi/split sound applications (separate picture and sound channel)
- Picture channel with Nyquist slope and sound suppression, symmetrical output
- Constant group delay
- Sound channel with pass band for sound carrier

### Terminals

- Tinned CuFe alloy

Plastic package **SIP 5 K**

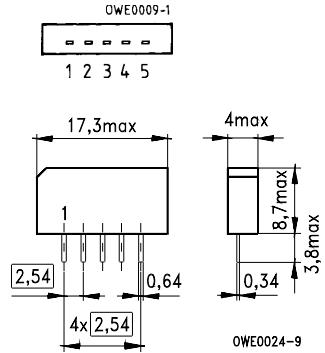

Dimensions in mm, approx. weight 1,0 g

### Pin configuration

- 1 Input
- 2 Chip carrier – ground
- 3 Output – sound
- 4 Output – picture
- 5 Output – picture

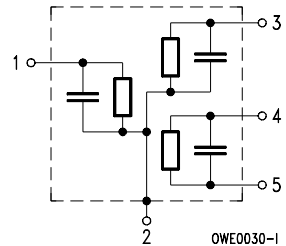

Type	Ordering code	Marking
N 3561 M	B39588-N3561-M201	Type, date code, pin 1

### Maximum ratings

Ambient temperature	$T_A$	- 25/+ 65	°C	—
Storage temperature	$T_{stg}$	- 25/+ 85	°C	—
DC voltage	$V_{DC}$	12	V	between any terminals
AC voltage	$V_{pp}$	10	V	between any terminals

# N 3561 M

## 58,75 MHz

### Characteristics of picture channel

Ambient temperature	$T_A = 25 (45) \text{ }^\circ\text{C}$
Source impedance	$Z_S = 50 \text{ } \Omega$
Load impedance	$Z_L = 2 \text{ k}\Omega \parallel 3 \text{ pF}$

		min.	typ.	max.	
<b>Insertion attenuation</b>					
	$\alpha$				
Reference level for the following data	57,08 (57,00) MHz	13,0	14,5	16,0	dB
<b>Relative attenuation</b>					
	$\alpha_{rel}$				
Picture carrier	58,83 (58,75) MHz	5,1	6,1	7,1	dB
Color carrier	55,25 (55,17) MHz	- 0,7	0,3	1,3	dB
Sound carrier	54,33 (54,25) MHz	22,0	29,0	—	dB
Adjacent picture carrier	52,83 (52,75) MHz	44,0	52,0	—	dB
Adjacent sound carrier	60,33 (60,25) MHz	40,0	50,0	—	dB
Lower sidelobe					
	45,08 ... 52,83 (45,00 ... 52,75) MHz	37,0	43,0	—	dB
Upper sidelobe					
	60,33 ... 65,08 (60,25 ... 65,00) MHz	37,0	43,0	—	dB
<b>Reflected wave signal suppression</b>					
1,2 $\mu\text{s}$ ... 6,0 $\mu\text{s}$ after main pulse (test pulse: 250 ns, carrier frequency: 57,08 MHz)		42,0	51,0	—	dB
<b>Feedthrough signal suppression</b>					
1,3 $\mu\text{s}$ ... 1,2 $\mu\text{s}$ before main pulse (test pulse: 250 ns, carrier frequency: 57,08 MHz)		—	56,0	—	dB
<b>Group delay ripple (p-p)</b>	$\Delta\tau$	—	50	—	ns
<b>Impedance at 57,08 MHz</b>					
Input: $Z_{IN} = R_{IN} \parallel C_{IN}$		—	0,8 $\parallel$ 17,6	—	k $\Omega$ $\parallel$ pF
Output: $Z_{OUT} = R_{OUT} \parallel C_{OUT}$		—	0,7 $\parallel$ 2,9	—	k $\Omega$ $\parallel$ pF
<b>Temperature coefficient of frequency</b>	$TC_f$	—	- 72	—	ppm/K

Frequency response

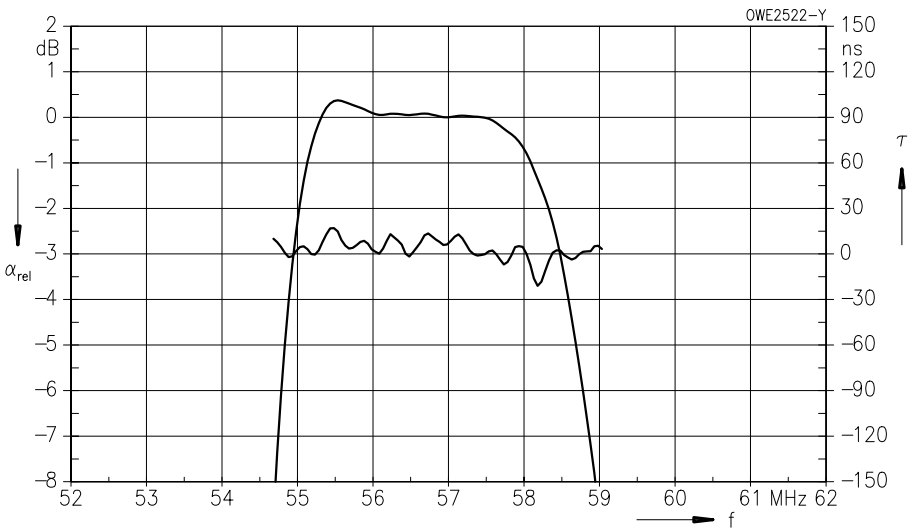
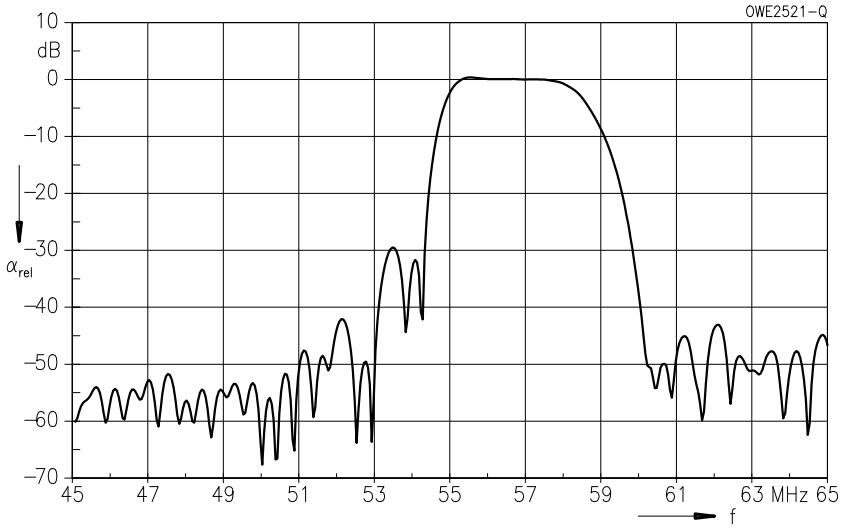

# N 3561 M

## 58,75 MHz

### Characteristics of sound channel

Ambient temperature  $T_A = 25 (45) \text{ }^\circ\text{C}$   
 Source impedance  $Z_S = 50 \text{ } \Omega$   
 Load impedance  $Z_L = 2 \text{ k}\Omega \parallel 3 \text{ pF}$

		min.	typ.	max.	
<b>Insertion attenuation</b> $\alpha$					
Reference level for the following data	54,33 (54,25) MHz	15,8	17,3	18,8	dB
<b>Relative attenuation</b> $\alpha_{rel}$					
Picture carrier	58,83 (58,75) MHz	27,0	34,0	—	dB
Color carrier	55,25 (55,17) MHz	17,0	22,0	—	dB
Adjacent picture carrier	52,83 (52,83) MHz	30,0	37,0	—	dB
Adjacent sound carrier	60,33 (60,25) MHz	33,0	41,0	—	dB
Lower sidelobe					
45,08 ... 52,83 (45,00 ... 52,75) MHz		27,0	33,0	—	dB
Upper sidelobe					
60,33 ... 65,08 (60,25 ... 65,00) MHz		31,0	38,0	—	dB
<b>Impedance at 54,33 MHz</b>					
Output: $Z_{OUT} = R_{OUT} \parallel C_{OUT}$		—	2,1 $\parallel$ 5,0	—	k $\Omega$ $\parallel$ pF
<b>Temperature coefficient of frequency</b> $TC_f$		—	-72	—	ppm/K

### Frequency response

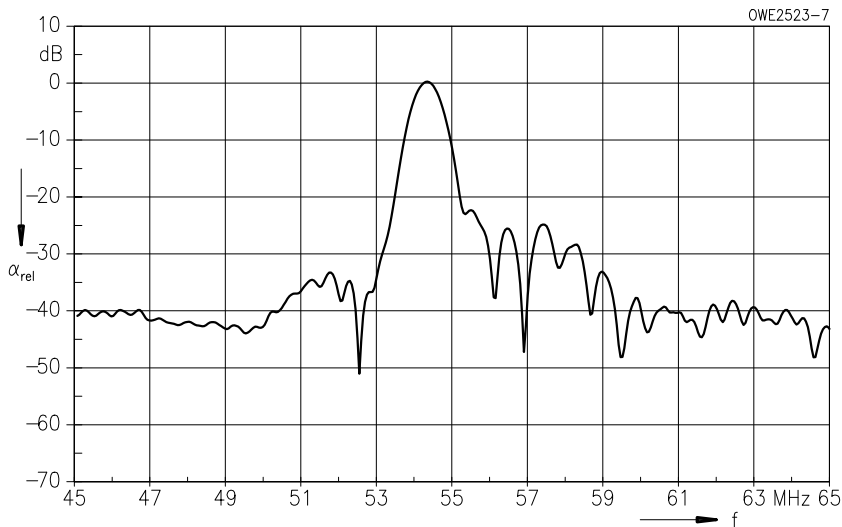

# IF Filters for Video Applications

## Survey

Picture carrier	Picture-to-sound carrier distance	Group delay <sup>1)</sup>	Sound carrier rejection <sup>2)</sup>	Standard <sup>3)</sup>	Package	Type	Page <sup>4)</sup>
MHz	MHz		dB				
33,40	- 6,5	F	30	L	SIP 5 K <sup>5)</sup>	G 3957 M	<a href="#">182</a>
	- 6,5	F	41	L	DIP 10 K	K 6260 K <sup>6)</sup>	#
33,90	- 6,5	F	59	L	SIP 5 K	K 3953 M	<a href="#">185</a>
	- 6,5	F	54	L	DIP 10 K <sup>5)</sup>	K 6256 K <sup>6)</sup>	#
	- 6,5	F	54	L	DIP 10 K <sup>5)</sup>	K 6257 K <sup>6)</sup>	<a href="#">188</a>
	- 6,5	C	58	L	DIP 10 K <sup>5)</sup>	K 6263 K <sup>6)</sup>	#
38,00	5,5 ... 6,5	F	40, 56	B/G, D/K	SIP 5 K	K 3955 M	<a href="#">193</a>
	5,5 ... 6,5	C	48, 60	B/G, D/K	DIP 10 K <sup>5)</sup>	K 6266 K <sup>6)</sup>	<a href="#">196</a>
	4,5	C	29	M/N	DIP 10 K <sup>5)</sup>	K 6266 K <sup>6)</sup>	<a href="#">196</a>
38,90	5,5	C	39	B/G	SIP 5 K	G 3956 M	<a href="#">201</a>
	5,5 ... 6,5	F	6, 45	B/G, L	SIP 5 K	G 3957 M	<a href="#">182</a>
	5,5	C	54	B/G	SIP 5 K	G 3962 M	#
	5,5	F	56	B/G	SIP 5 K	G 3963 M	#
	5,5	C	51	B/G	SIP 5 K	G 3964 M	#
	5,5	F	51	B/G	SIP 5 K	G 3965 M	<a href="#">204</a>
	5,5	C	61	B/G	SIP 5 K	G 3967 M	#
	5,5 ... 6,5	F	24, 54, 62	B/G, I, D/K, L	SIP 5 K	K 3953 M	<a href="#">185</a>
	6,0 ... 6,5	F	53, 50	D/K, I, L	DIP 10 K <sup>5)</sup>	K 6256 K <sup>6)</sup>	#
	5,5	C	44	B/G	DIP 10 K <sup>5)</sup>	K 6257 K <sup>6)</sup>	<a href="#">188</a>
	6,0 ... 6,5	F	52, 58	D/K, I, L	DIP 10 K <sup>5)</sup>	K 6257 K <sup>6)</sup>	<a href="#">188</a>
	6,5	F	51	L	DIP 10 K <sup>5)</sup>	K 6260 K <sup>6)</sup>	#
	5,5	F	44	B/G	DIP 10 K <sup>5)</sup>	K 6262 K <sup>6)</sup>	#
	5,5 ... 6,5	C	42, 61	B/G, L	DIP 10 K <sup>5)</sup>	K 6263 K <sup>6)</sup>	#
	4,5	F	29	M/N	DIP 10 K <sup>5)</sup>	K 6263 K <sup>6)</sup>	#
4,5	F	45	M/N	SIP 5 K	M 3960 M	#	
39,50	6,0	F	50	I	SIP 5 K	J 3950 M	<a href="#">207</a>
45,75	4,5	C	32	M/N	SIP 5 K	M 3951 M	<a href="#">210</a>
58,75	4,5	F	40	M	SIP 5 K	N 3954 M	<a href="#">213</a>
	4,5	F	40	M	SIP 5 K	N 3958 M	#

1) C: Customized  
F: Flat

2) Typ., referred to filter roof

3) For explanation of standards see individual data sheets or index on page [349](#)

4) Filters marked by the sign # are only listed in the survey. Detailed information on these types upon request.

5) Pin configuration different from standard package

6) Internally switchable multistandard filter

### Standard

- B/G-CCIR  
Germany, Europe partly
- L/L'  
France

### Features

- TV IF filter with Nyquist slopes at 33,40 MHz and 38,90 MHz
- Constant group delay
- Suitable for CENELEC EN 55020

### Terminals

- Tinned CuFe alloy

Plastic package **SIP 5 K**

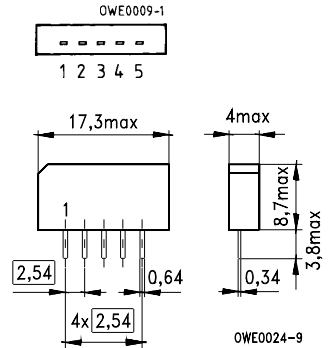

Dimensions in mm, approx. weight 1,0 g

### Pin configuration

- 1 Input
- 2 Input – ground
- 3 Chip carrier – ground
- 4 Output
- 5 Output

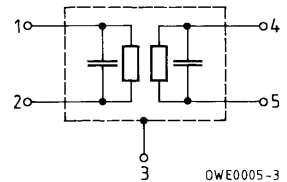

Type	Ordering code	Marking
G 3957 M	B39389-G3957-M100	Type, date code, pin 1

### Maximum ratings

Ambient temperature	$T_A$	- 25/+ 65	°C	—
Storage temperature	$T_{stg}$	- 25/+ 85	°C	—
DC voltage	$V_{DC}$	12	V	between any terminals
AC voltage	$V_{pp}$	10	V	between any terminals

**Characteristics**

Ambient temperature  $T_A = 25\text{ °C}$   
 Source impedance  $Z_S = 50\ \Omega$   
 Load impedance  $Z_L = 2\text{ k}\Omega \parallel 3\text{ pF}$

		min.	typ.	max.	
<b>Insertion attenuation</b>					
Reference level for the following data	37,40 MHz	$\alpha$ 14,4	15,9	17,4	dB
<b>Relative attenuation</b>					
Picture carrier B/G, L'	38,90 MHz	$\alpha_{rel}$ 4,8	5,8	6,8	dB
Picture carrier L'	33,40 MHz	5,0	6,0	7,0	dB
Adjacent picture carrier	30,90 MHz	48,0	60,0	—	dB
	31,90 MHz	48,0	62,0	—	dB
Adjacent sound carrier	40,40 MHz	46,0	56,0	—	dB
	41,40 MHz	41,0	46,0	—	dB
Lower sidelobe	25,00 ... 31,90 MHz	40,0	46,0	—	dB
Upper sidelobe	40,40 ... 45,00 MHz	38,0	43,0	—	dB
<b>Reflected wave signal suppression</b>					
1,1 $\mu$ s ... 6,0 $\mu$ s after main pulse (test pulse: 250 ns, carrier frequency: 37,40 MHz)		44,0	56,0	—	dB
<b>Feedthrough signal suppression</b>					
1,1 $\mu$ s ... 1,0 $\mu$ s before main pulse (test pulse: 250 ns, carrier frequency: 37,40 MHz)		50,0	56,0	—	dB
<b>Group delay ripple (p-p)</b>		$\Delta\tau$ —	40	—	ns
<b>Impedance at 37,40 MHz</b>					
Input: $Z_{IN} = R_{IN} \parallel C_{IN}$		—	1,6 $\parallel$ 15,0	—	k $\Omega$ $\parallel$ pF
Output: $Z_{OUT} = R_{OUT} \parallel C_{OUT}$		—	1,6 $\parallel$ 4,3	—	k $\Omega$ $\parallel$ pF
<b>Temperature coefficient of frequency</b>	$TC_f$	—	-72	—	ppm/K

**G 3957 M**  
**33,40/38,90 MHz**

**Frequency response**

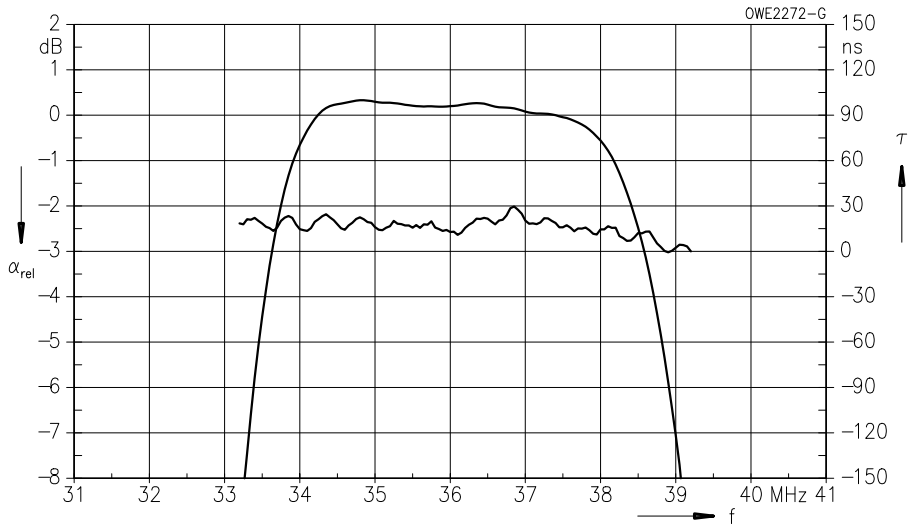
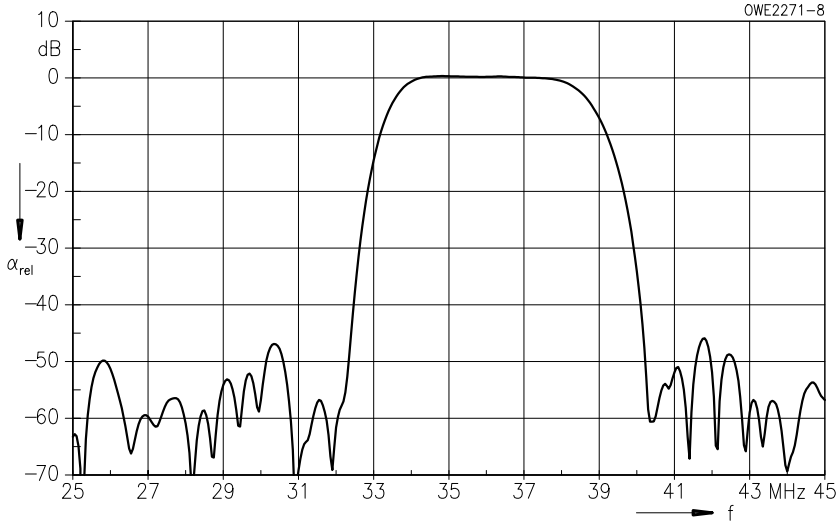



### Standard

- B/G-CCIR  
Germany, Europe partly
- D/K  
Eastern standard
- I  
Great Britain
- L/L'  
France

### Features

- TV IF filter with Nyquist slopes at 33,90 MHz and 38,90 MHz
- Constant group delay
- Suitable for CENELEC EN 55020

### Terminals

- Tinned CuFe alloy

### Pin configuration

- 1 Input
- 2 Input – ground
- 3 Chip carrier – ground
- 4 Output
- 5 Output

Plastic package **SIP 5 K**

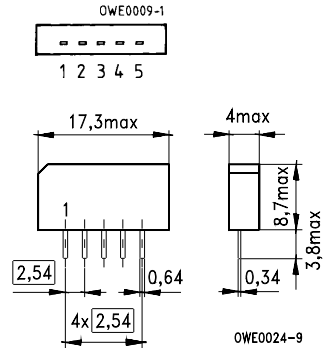

Dimensions in mm, approx. weight 1,0 g

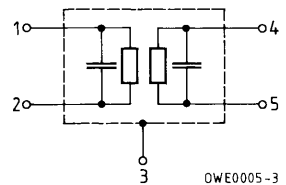

Type	Ordering code	Marking
K 3953 M	B39389-K3953-M100	Type, date code, pin 1

### Maximum ratings

Ambient temperature	$T_A$	- 25/+ 65	°C	—
Storage temperature	$T_{stg}$	- 25/+ 85	°C	—
DC voltage	$V_{DC}$	12	V	between any terminals
AC voltage	$V_{pp}$	10	V	between any terminals

**K 3953 M**  
**33,90/38,90 MHz**

**Characteristics**

Ambient temperature  $T_A = 25\text{ °C}$   
 Source impedance  $Z_S = 50\ \Omega$   
 Load impedance  $Z_L = 2\text{ k}\Omega \parallel 3\text{ pF}$

		min.	typ.	max.		
<b>Insertion attenuation</b>						
Reference level for the following data	37,40 MHz	$\alpha$	12,0	13,5	15,0	dB
<b>Relative attenuation</b>						
Picture carrier	38,90 MHz	$\alpha_{rel}$	4,7	5,7	6,7	dB
	33,90 MHz		6,3	7,5	8,7	dB
Sound carrier	33,40 MHz		20,0	24,0	—	dB
Adjacent picture carrier	UHF 30,90 MHz		48,0	62,0	—	dB
	VHF 31,90 MHz		48,0	59,0	—	dB
	40,15 MHz		36,0	40,0	—	dB
Adjacent sound carrier	VHF 40,40 MHz		47,0	59,0	—	dB
	UHF 41,40 MHz		46,0	60,0	—	dB
	40,90 MHz		46,0	59,0	—	dB
Lower sidelobe	25,00 ... 31,90 MHz		45,0	52,0	—	dB
Upper sidelobe	40,40 ... 45,00 MHz		38,0	44,0	—	dB
<b>Reflected wave signal suppression</b>						
1,2 $\mu$ s ... 6,0 $\mu$ s after main pulse (test pulse: 250 ns, carrier frequency: 37,40 MHz)			42,0	50,0	—	dB
<b>Feedthrough signal suppression</b>						
1,2 $\mu$ s ... 1,1 $\mu$ s before main pulse (test pulse: 250 ns, carrier frequency: 37,40 MHz)			50,0	56,0	—	dB
<b>Group delay ripple (p-p)</b>		$\Delta\tau$	—	50	—	ns
<b>Impedance at 37,40 MHz</b>						
Input: $Z_{IN} = R_{IN} \parallel C_{IN}$			—	1,5 $\parallel$ 14,2	—	k $\Omega$ $\parallel$ pF
Output: $Z_{OUT} = R_{OUT} \parallel C_{OUT}$			—	1,5 $\parallel$ 5,4	—	k $\Omega$ $\parallel$ pF
<b>Temperature coefficient of frequency</b>		$TC_f$	—	-72	—	ppm/K

Frequency response

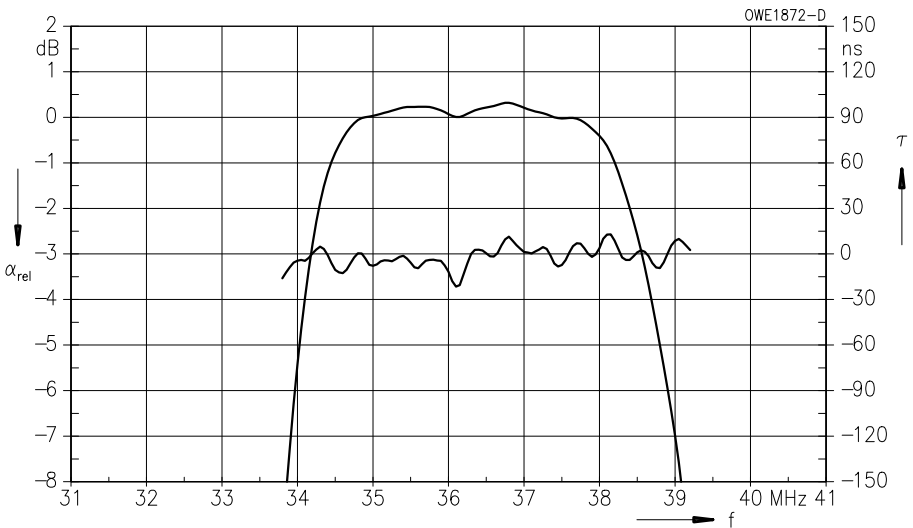
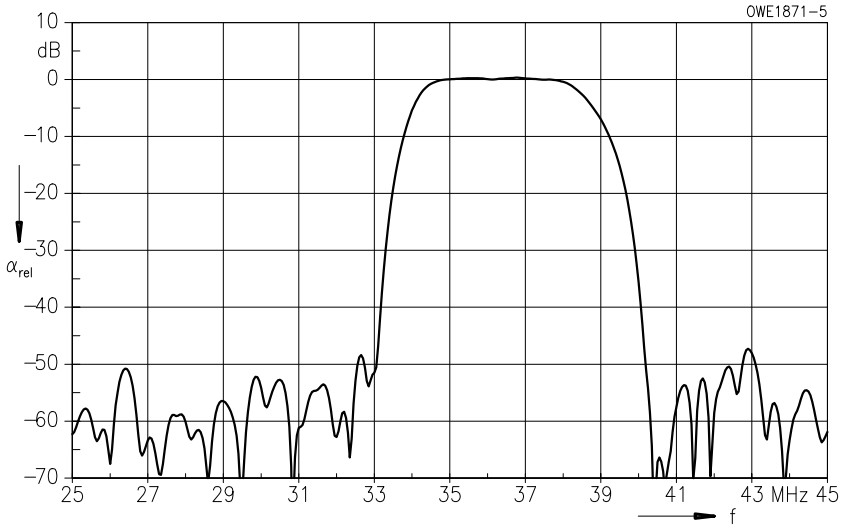

### Standard

- B/G-CCIR  
Germany, Europe partly
- D/K-OIRT  
Eastern standard
- I  
Great Britain
- L/L'  
France

Plastic package DIP 10 K

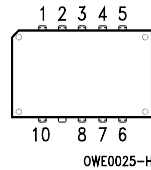

### Features

- TV IF filter switchable from B/G mode to L/L' mode
- B/G mode with Nyquist slope and sound suppression
- Reduced group delay distortion as compared with standard B/G half
- L/L' mode with Nyquist slopes at 38,90 MHz and 33,90 MHz
- Constant group delay
- Suitable for CENELEC EN 55020

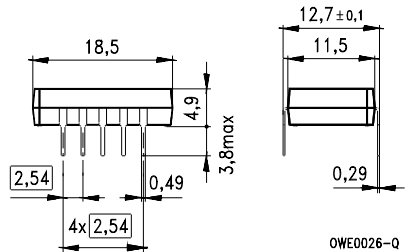

Dimensions in mm, approx. weight 1,8 g

### Terminals

- Tinned CuFe alloy

### Pin configuration

- 1 Input
- 2 Input – ground
- 3, 8 Chip carrier – ground
- 4, 5 Output
- 6, 7 Not connected
- 9 Free
- 10 Switching input

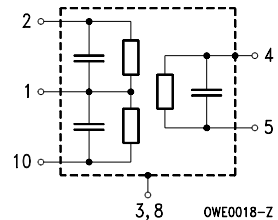

Type	Ordering code	Marking
K 6257 K	B39389-K6257-K100	Type, date code, pin 1

### Maximum ratings

Ambient temperature	$T_A$	- 25/+ 65	°C	—
Storage temperature	$T_{stg}$	- 25/+ 85	°C	—
DC voltage	$V_{DC}$	12	V	between any terminals
AC voltage	$V_{pp}$	10	V	between any terminals

**Characteristics in B/G mode (switching input pin 10 connected to ground input pin 2)**

Ambient temperature  $T_A = 25\text{ °C}$   
 Source impedance  $Z_S = 50\ \Omega$   
 Load impedance  $Z_L = 2\text{ k}\Omega \parallel 3\text{ pF}$

		min.	typ.	max.		
<b>Insertion attenuation</b>						
Reference level for the following data	37,40 MHz	$\alpha$	14,5	16,0	17,5	dB
<b>Relative attenuation</b>						
Picture carrier	38,90 MHz	$\alpha_{rel}$	4,7	5,7	6,7	dB
Color carrier	34,47 MHz		0,3	1,3	2,3	dB
Sound carrier	33,40 MHz		35,0	44,0	—	dB
Adjacent picture carrier	UHF 30,90 MHz		44,0	60,0	—	dB
	VHF 31,90 MHz		46,0	60,0	—	dB
	32,40 MHz		46,0	60,0	—	dB
	40,15 MHz		38,0	45,0	—	dB
Adjacent sound carrier	VHF 40,40 MHz		43,0	54,0	—	dB
Adjacent picture carrier	UHF 41,40 MHz		40,0	48,0	—	dB
Lower sidelobe	25,00 ... 31,90 MHz		42,0	48,0	—	dB
Upper sidelobe	40,40 ... 45,00 MHz		38,0	45,0	—	dB
<b>Reflected wave signal suppression</b>						
1,2 $\mu$ s ... 6,0 $\mu$ s after main pulse (test pulse: 250 ns, carrier frequency: 37,40 MHz)			42,0	50,0	—	dB
<b>Feedthrough signal suppression</b>						
1,2 $\mu$ s ... 1,1 $\mu$ s before main pulse (test pulse: 250 ns, carrier frequency: 37,40 MHz)			—	56,0	—	dB
<b>Group delay predistortion</b>						
(reference frequency 38,90 MHz)		$\Delta\tau$				
	36,10 MHz		—	- 55	—	ns
	34,47 MHz		—	70	—	ns
<b>Impedance at 37,40 MHz</b>						
Input: $Z_{IN} = R_{IN} \parallel C_{IN}$			—	0,9 $\parallel$ 23,6	—	k $\Omega$ $\parallel$ pF
Output: $Z_{OUT} = R_{OUT} \parallel C_{OUT}$			—	0,9 $\parallel$ 6,5	—	k $\Omega$ $\parallel$ pF
<b>Temperature coefficient of frequency</b>		$TC_f$	—	- 72	—	ppm/K

Frequency response (B/G mode)

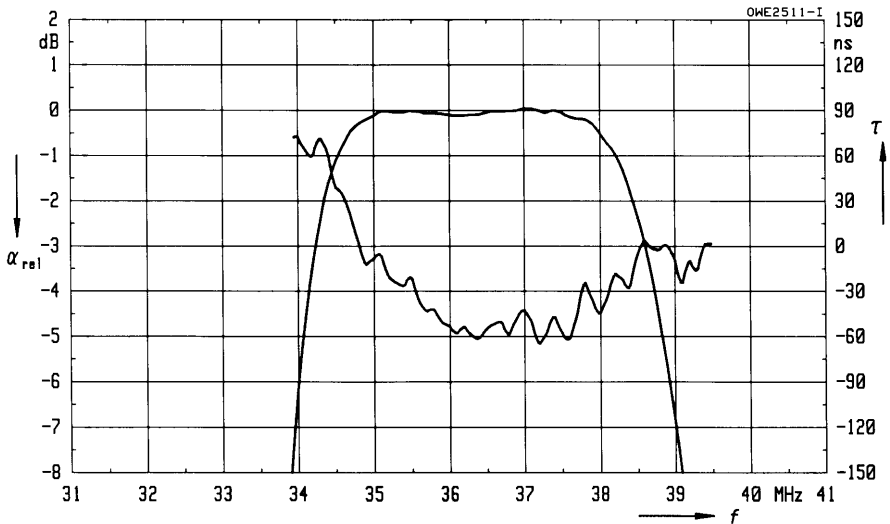
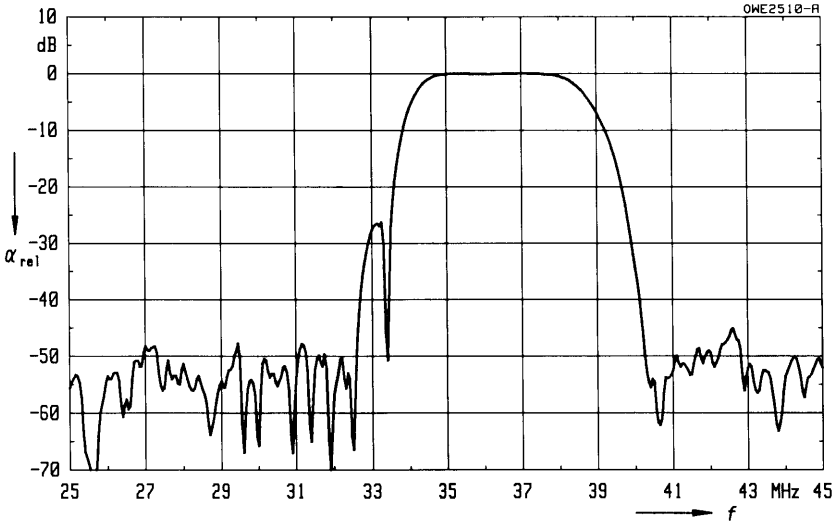

**Characteristics in L/L' mode (switching input pin 10 connected to input pin 1)**

Ambient temperature  $T_A = 25\text{ °C}$   
 Source impedance  $Z_S = 50\ \Omega$   
 Load impedance  $Z_L = 2\text{ k}\Omega \parallel 3\text{ pF}$

		min.	typ.	max.		
<b>Insertion attenuation</b>						
Reference level for the following data	37,40 MHz	$\alpha$	14,6	16,1	17,6	dB
<b>Relative attenuation</b>						
Picture carrier	38,90 MHz	$\alpha_{rel}$	4,4	5,4	6,4	dB
	33,90 MHz		5,6	6,6	7,6	dB
	34,47 MHz		-0,2	0,8	1,8	dB
	30,90 MHz		46,0	58,0	—	dB
	32,40 MHz		46,0	58,0	—	dB
	32,90 MHz		42,0	52,0	—	dB
	40,40 MHz		43,0	54,0	—	dB
	40,90 MHz		42,0	52,0	—	dB
	41,90 MHz		41,0	48,0	—	dB
Lower sidelobe	25,00 ... 32,90 MHz		41,0	46,0	—	dB
Upper sidelobe	40,40 ... 45,00 MHz		39,0	45,0	—	dB
<b>Reflected wave signal suppression</b>						
1,2 $\mu$ s ... 6,0 $\mu$ s after main pulse (test pulse: 250 ns, carrier frequency: 37,40 MHz)			42,0	52,0	—	dB
<b>Feedthrough signal suppression</b>						
1,2 $\mu$ s ... 1,1 $\mu$ s before main pulse (test pulse: 250 ns, carrier frequency: 37,40 MHz)			—	56,0	—	dB
<b>Group delay ripple (p-p)</b>						
		$\Delta\tau$	—	50	—	ns
<b>Impedance at 37,40 MHz</b>						
Input: $Z_{IN} = R_{IN} \parallel C_{IN}$			—	1,5 $\parallel$ 16,9	—	k $\Omega$ $\parallel$ pF
Output: $Z_{OUT} = R_{OUT} \parallel C_{OUT}$			—	0,9 $\parallel$ 6,5	—	k $\Omega$ $\parallel$ pF
<b>Temperature coefficient of frequency</b>						
		$TC_f$	—	-72	—	ppm/K

Frequency response (L/L' mode)

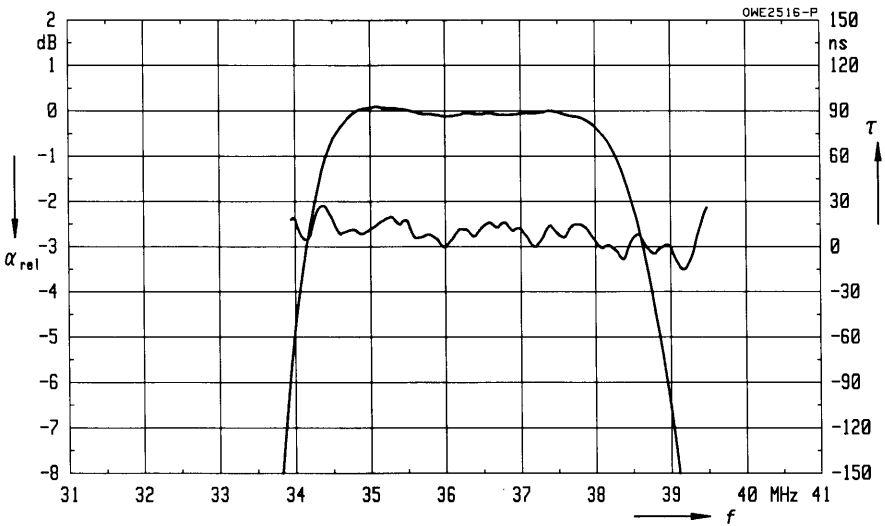
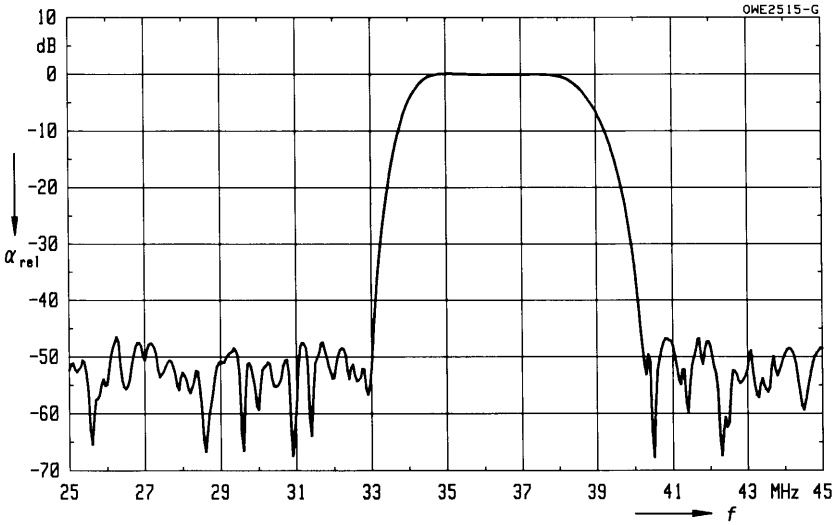



### Standard

- D/K-OIRT  
Eastern standard
- B/G-CCIR  
Europe partly

### Features

- TV IF filter with Nyquist slope and sound suppression
- High color carrier level
- Constant group delay
- Suitable for CENELEC EN 55020

### Terminals

- Tinned CuFe alloy

Plastic package **SIP 5 K**

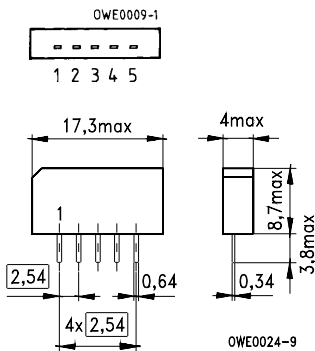

Dimensions in mm, approx. weight 1,0 g

### Pin configuration

- 1 Input
- 2 Input – ground
- 3 Chip carrier – ground
- 4 Output
- 5 Output

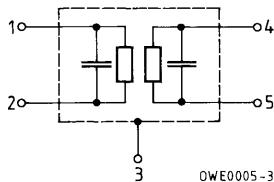

Type	Ordering code	Marking
K 3955 M	B39380-K3955-M100	Type, date code, pin 1

### Maximum ratings

Ambient temperature	$T_A$	- 25/+ 65	°C	—
Storage temperature	$T_{stg}$	- 25/+ 85	°C	—
DC voltage	$V_{DC}$	12	V	between any terminals
AC voltage	$V_{pp}$	10	V	between any terminals

# K 3955 M

## 38,00 MHz

### Characteristics

Ambient temperature	$T_A = 25\text{ °C}$
Source impedance	$Z_S = 50\ \Omega$
Load impedance	$Z_L = 2\text{ k}\Omega \parallel 3\text{ pF}$

		min.	typ.	max.	
<b>Insertion attenuation</b>					
Reference level for the following data	36,50 MHz	13,3	14,8	16,3	dB
<b>Relative attenuation</b>					
Picture carrier	38,00 MHz	4,7	5,7	6,7	dB
Color carrier	33,57 MHz	-0,2	0,8	1,8	dB
Sound carrier	31,50 MHz	46,0	56,0	—	dB
	32,50 MHz	30,0	40,0	—	dB
Adjacent picture carrier	30,00 MHz	48,0	60,0	—	dB
	31,00 MHz	50,0	62,0	—	dB
Adjacent sound carrier	39,50 MHz	46,0	56,0	—	dB
	40,50 MHz	44,0	58,0	—	dB
Lower sidelobe	25,00 ... 30,00 MHz	41,0	48,0	—	dB
Upper sidelobe	39,50 ... 45,00 MHz	38,0	43,0	—	dB
<b>Reflected wave signal suppression</b>					
1,2 $\mu$ s ... 6,0 $\mu$ s after main pulse (test pulse: 250 ns, carrier frequency: 36,50 MHz)		42,0	55,0	—	dB
<b>Feedthrough signal suppression</b>					
1,2 $\mu$ s ... 1,1 $\mu$ s before main pulse (test pulse: 250 ns, carrier frequency: 36,50 MHz)		50,0	56,0	—	dB
<b>Group delay ripple (p-p)</b>	$\Delta\tau$	—	40	—	ns
<b>Impedance at 36,50 MHz</b>					
Input:	$Z_{IN} = R_{IN} \parallel C_{IN}$	—	1,5 $\parallel$ 15,5	—	k $\Omega$ $\parallel$ pF
Output:	$Z_{OUT} = R_{OUT} \parallel C_{OUT}$	—	1,9 $\parallel$ 3,9	—	k $\Omega$ $\parallel$ pF
<b>Temperature coefficient of frequency</b>	$TC_f$	—	-72	—	ppm/K

Frequency response

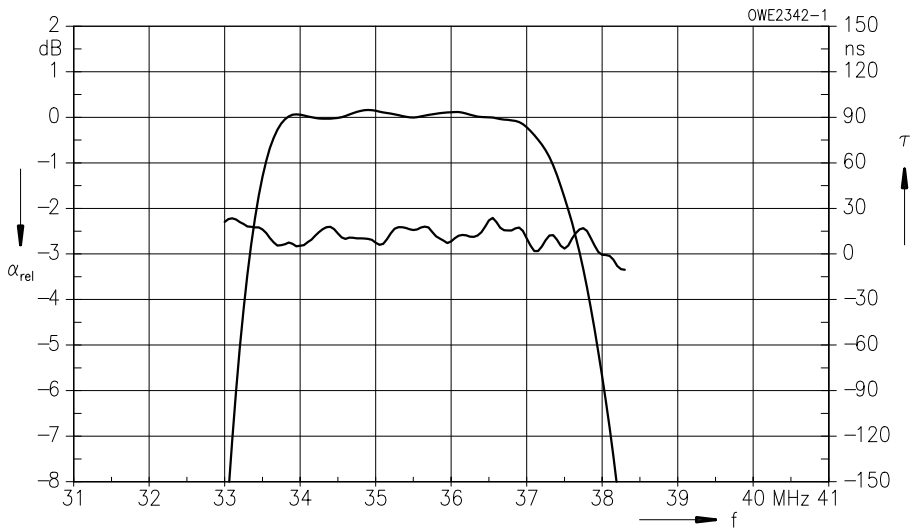
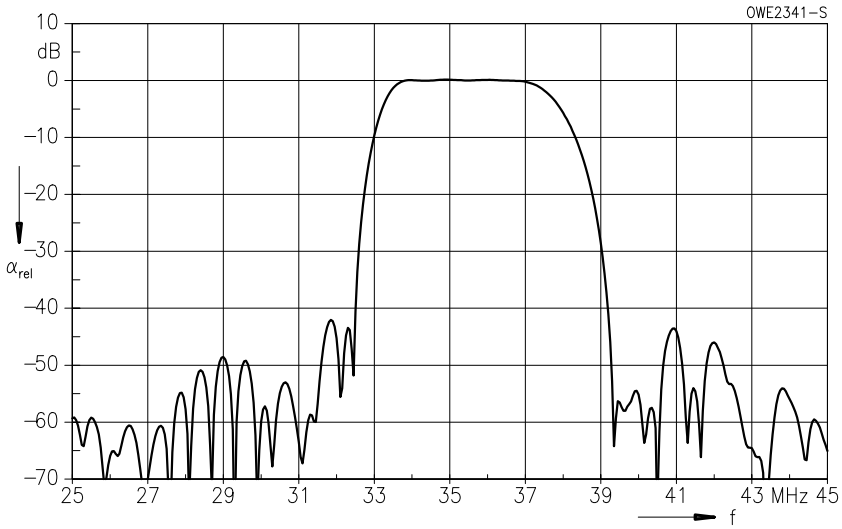

## Standard

- B/G-CCIR  
Germany, Europe partly
- D/K-OIRT  
Eastern standard
- M/N-FCC  
USA

Plastic package DIP 10 K

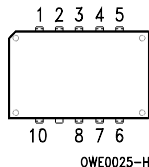

## Features

- TV IF filter switchable from M/N mode to B/G mode
- M/N mode with Nyquist slope and sound suppression
- Customized group delay predistortion
- B/G mode with Nyquist slope and sound suppression
- Reduced group delay predistortion as compared with standard B/G, half
- Suitable for CENELEC EN 55020

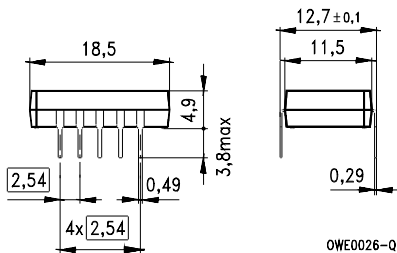

Dimensions in mm, approx. weight 1,8 g

## Terminals

- Tinned CuFe alloy

## Pin configuration

- 1 Input
- 2 Input – ground
- 3, 8 Chip carrier – ground
- 4, 5 Output
- 6, 7 Not connected
- 9 Free
- 10 Switching input

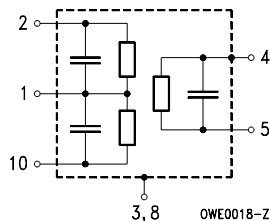

Type	Ordering code	Marking
K 6266 K	B39380-K6266-K100	Type, date code, pin 1

## Maximum ratings

Ambient temperature	$T_A$	- 25/+ 65	°C	—
Storage temperature	$T_{stg}$	- 25/+ 85	°C	—
DC voltage	$V_{DC}$	12	V	between any terminals
AC voltage	$V_{pp}$	10	V	between any terminals

**Characteristics in M/N mode (switching input pin 10 connected to input pin 1)**

Ambient temperature  $T_A = 25\text{ °C}$   
 Source impedance  $Z_S = 50\ \Omega$   
 Load impedance  $Z_L = 2\text{ k}\Omega \parallel 3\text{ pF}$

		min.	typ.	max.	
<b>Insertion attenuation</b>					
Reference level for the following data	36,50 MHz	14,4	15,9	17,4	dB
<b>Relative attenuation</b>					
Picture carrier	38,00 MHz	4,5	5,5	6,5	dB
Color carrier	34,42 MHz	1,3	2,3	3,3	dB
Sound carrier	33,50 MHz	24,0	29,0	—	dB
Adjacent picture carrier	32,00 MHz	46,0	58,0	—	dB
Adjacent sound carrier	39,50 MHz	46,0	58,0	—	dB
Lower sidelobe	25,00 ... 32,00 MHz	36,0	42,0	—	dB
Upper sidelobe	39,50 ... 45,00 MHz	38,0	43,0	—	dB
<b>Reflected wave signal suppression</b>					
1,2 $\mu$ s ... 6,0 $\mu$ s after main pulse (test pulse: 250 ns, carrier frequency: 36,50 MHz)		42,0	51,0	—	dB
<b>Feedthrough signal suppression</b>					
1,2 $\mu$ s ... 1,1 $\mu$ s before main pulse (test pulse: 250 ns, carrier frequency: 36,50 MHz)		—	56,0	—	dB
<b>Group delay predistortion</b>					
(reference frequency 38,00 MHz)					
	35,00 MHz	—	20	—	ns
	34,42 MHz	—	70	—	ns
<b>Impedance at 36,50 MHz</b>					
Input: $Z_{IN} = R_{IN} \parallel C_{IN}$		—	1,1 $\parallel$ 21,2	—	k $\Omega$ $\parallel$ pF
Output: $Z_{OUT} = R_{OUT} \parallel C_{OUT}$		—	1,4 $\parallel$ 6,5	—	k $\Omega$ $\parallel$ pF
<b>Temperature coefficient of frequency</b>	$TC_f$	—	- 72	—	ppm/K

**Frequency response (M/N mode)**

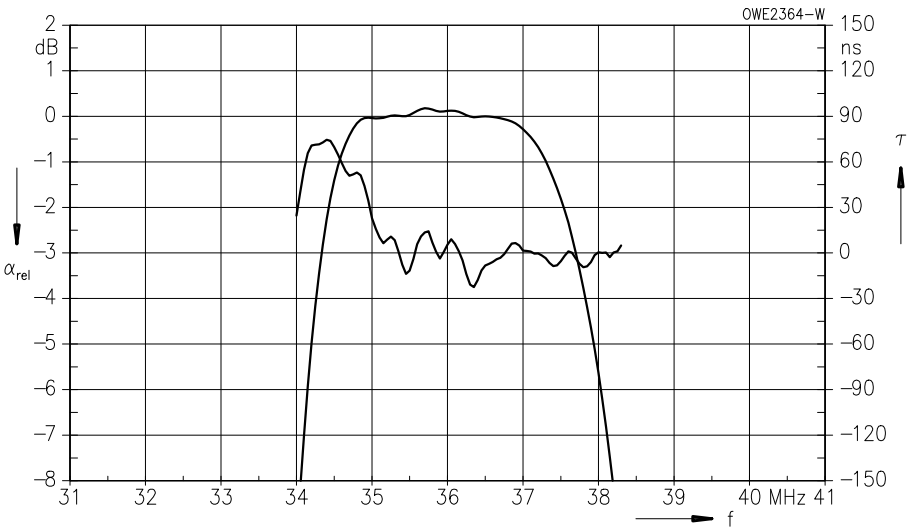
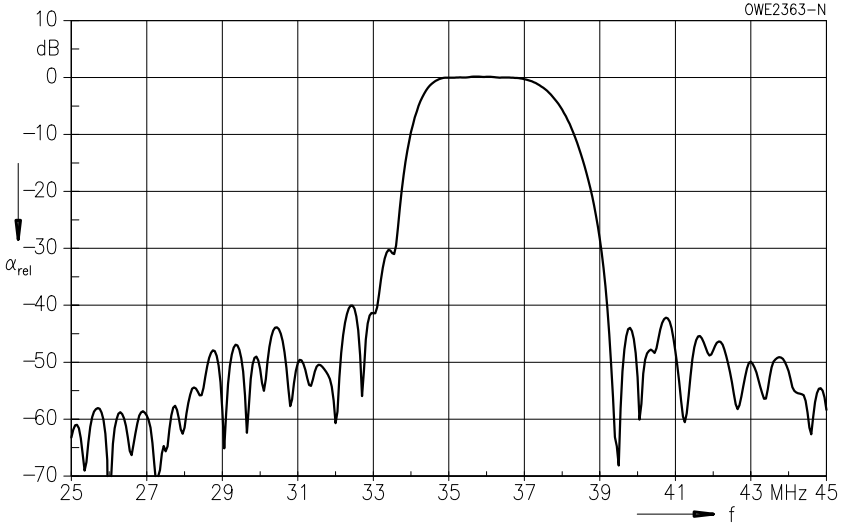

**Characteristics in B/G mode (switching input pin 10 connected to ground input pin 2)**

Ambient temperature  $T_A = 25\text{ }^\circ\text{C}$   
 Source impedance  $Z_S = 50\ \Omega$   
 Load impedance  $Z_L = 2\ \text{k}\Omega \parallel 3\ \text{pF}$

		min.	typ.	max.	
<b>Insertion attenuation</b>					
Reference level for the following data	36,50 MHz	$\alpha$ 14,4	15,9	17,4	dB
<b>Relative attenuation</b>					
Picture carrier	38,00 MHz	$\alpha_{\text{rel}}$ 4,6	5,6	6,6	dB
Color carrier	33,57 MHz	1,2	2,2	3,2	dB
Sound carrier	32,50 MHz	38,0	48,0	—	dB
	32,00 MHz	27,0	32,0	—	dB
	31,50 MHz	48,0	60,0	—	dB
Adjacent picture carrier	30,00 MHz	46,0	56,0	—	dB
	31,00 MHz	46,0	56,0	—	dB
Adjacent sound carrier	39,50 MHz	44,0	54,0	—	dB
	40,00 MHz	42,0	51,0	—	dB
	40,50 MHz	—	46,0	—	dB
Lower sidelobe	25,00 ... 30,00 MHz	42,0	49,0	—	dB
Upper sidelobe	39,50 ... 45,00 MHz	36,0	41,0	—	dB
<b>Reflected wave signal suppression</b>					
1,2 $\mu\text{s}$ ... 6,0 $\mu\text{s}$ after main pulse (test pulse: 250 ns, carrier frequency: 36,50 MHz)		42,0	50,0	—	dB
<b>Feedthrough signal suppression</b>					
1,2 $\mu\text{s}$ ... 1,1 $\mu\text{s}$ before main pulse (test pulse: 250 ns, carrier frequency: 36,50 MHz)		—	56,0	—	dB
<b>Group delay predistortion</b>					
(reference frequency 38,00 MHz)		$\Delta\tau$			
	36,00 MHz	—	- 50	—	ns
	33,57 MHz	—	70	—	ns
<b>Impedance at 36,50 MHz</b>					
Input: $Z_{\text{IN}} = R_{\text{IN}} \parallel C_{\text{IN}}$		—	0,9 $\parallel$ 25,6	—	$\text{k}\Omega \parallel \text{pF}$
Output: $Z_{\text{OUT}} = R_{\text{OUT}} \parallel C_{\text{OUT}}$		—	1,0 $\parallel$ 6,5	—	$\text{k}\Omega \parallel \text{pF}$
<b>Temperature coefficient of frequency</b>		$TC_f$	—	- 72	ppm/K

**Frequency response (B/G mode)**

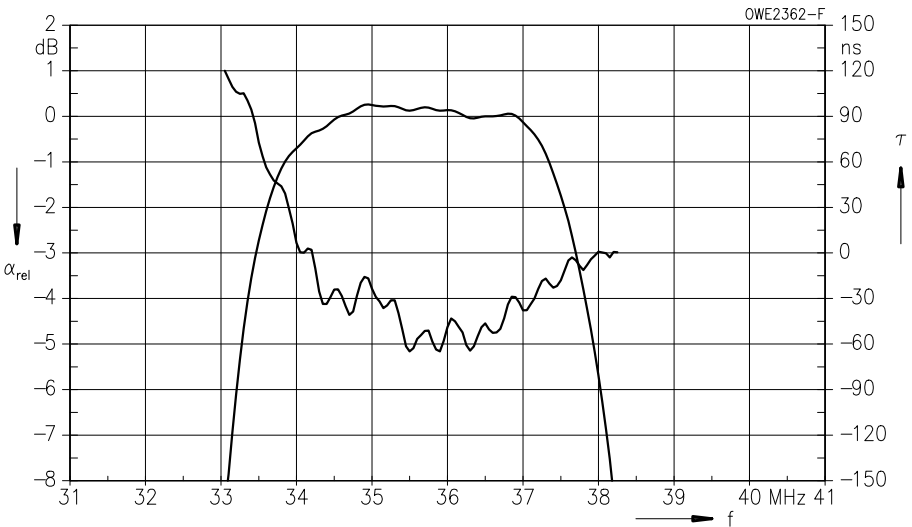
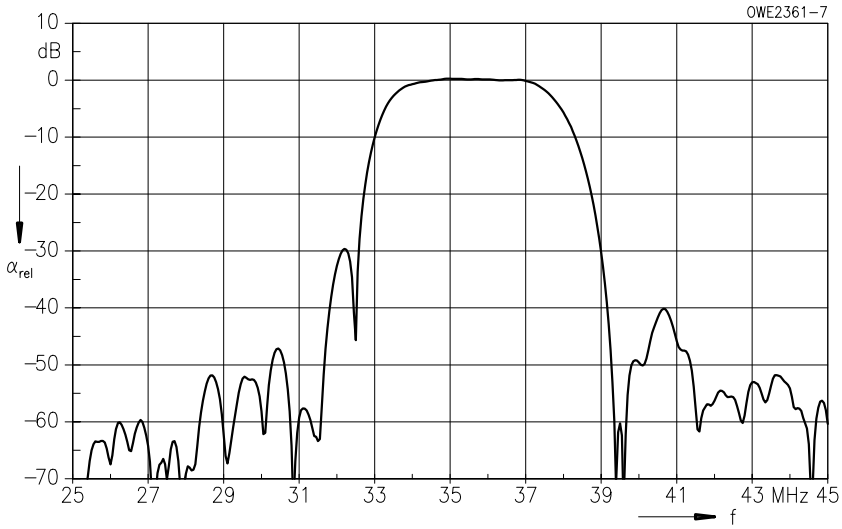



## Standard

- B/G-CCIR  
Germany, Europe partly

## Features

- TV IF filter with Nyquist slope and sound suppression
- High color carrier level
- Reduced group delay predistortion as compared with standard B/G, half
- Suitable for CENELEC EN 55020

## Terminals

- Tinned CuFe alloy

Plastic package **SIP 5 K**

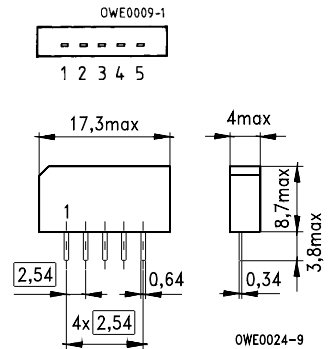

Dimensions in mm, approx. weight 1,0 g

## Pin configuration

- 1 Input
- 2 Input – ground
- 3 Chip carrier – ground
- 4 Output
- 5 Output

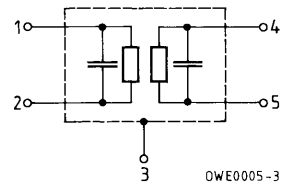

Type	Ordering code	Marking
G 3956 M	B39389-G3956-M100	Type, date code, pin 1

## Maximum ratings

Ambient temperature	$T_A$	- 25/+ 65	°C	–
Storage temperature	$T_{stg}$	- 25/+ 85	°C	–
DC voltage	$V_{DC}$	12	V	between any terminals
AC voltage	$V_{pp}$	10	V	between any terminals

# G 3956 M

## 38,90 MHz

### Characteristics

Ambient temperature	$T_A = 25\text{ °C}$
Source impedance	$Z_S = 50\ \Omega$
Load impedance	$Z_L = 2\text{ k}\Omega \parallel 3\text{ pF}$

		min.	typ.	max.		
<b>Insertion attenuation</b>						
Reference level for the following data	37,40 MHz	$\alpha$ 12,4	13,9	15,4	dB	
<b>Relative attenuation</b>						
Picture carrier	38,90 MHz	$\alpha_{rel}$ 5,1	6,1	7,1	dB	
Color carrier	34,47 MHz	0,0	1,0	2,0	dB	
Sound carrier	33,40 MHz	26,0	39,0	—	dB	
	33,15 MHz	—	25,0	—	dB	
	33,90 MHz	—	7,0	—	dB	
Adjacent picture carrier	UHF 30,90 MHz	48,0	58,0	—	dB	
	VHF 31,90 MHz	48,0	56,0	—	dB	
	31,40 MHz	44,0	52,0	—	dB	
	32,40 MHz	48,0	60,0	—	dB	
Adjacent stereo sound carrier	40,15 MHz	42,0	51,0	—	dB	
Adjacent sound carrier	VHF 40,40 MHz	44,0	51,0	—	dB	
	UHF 41,40 MHz	41,0	46,0	—	dB	
Lower sidelobe	25,00 ... 31,90 MHz	42,0	49,0	—	dB	
Upper sidelobe	40,40 ... 45,00 MHz	40,0	46,0	—	dB	
<b>Reflected wave signal suppression</b>						
1,3 $\mu$ s ... 6,0 $\mu$ s after main pulse (test pulse: 250 ns, carrier frequency: 37,40 MHz)		42,0	52,0	—	dB	
<b>Feedthrough signal suppression</b>						
1,2 $\mu$ s ... 1,1 $\mu$ s before main pulse (test pulse: 250 ns, carrier frequency: 37,40 MHz)		50,0	56,0	—	dB	
<b>Group delay predistortion</b>						
(reference frequency 38,90 MHz)		$\Delta\tau$				
	36,90 MHz	—	- 85	—	ns	
	34,47 MHz	—	70	—	ns	
<b>Impedance at 37,40 MHz</b>						
Input:	$Z_{IN} = R_{IN} \parallel C_{IN}$	—	1,3 $\parallel$ 16,6	—	k $\Omega$ $\parallel$ pF	
Output:	$Z_{OUT} = R_{OUT} \parallel C_{OUT}$	—	1,4 $\parallel$ 4,5	—	k $\Omega$ $\parallel$ pF	
<b>Temperature coefficient of frequency</b>		$TC_f$	—	- 72	—	ppm/K

Frequency response

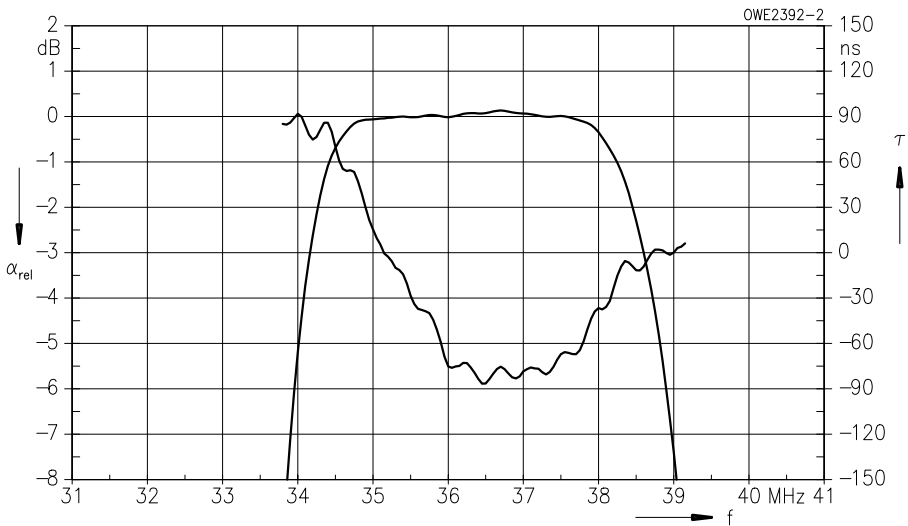
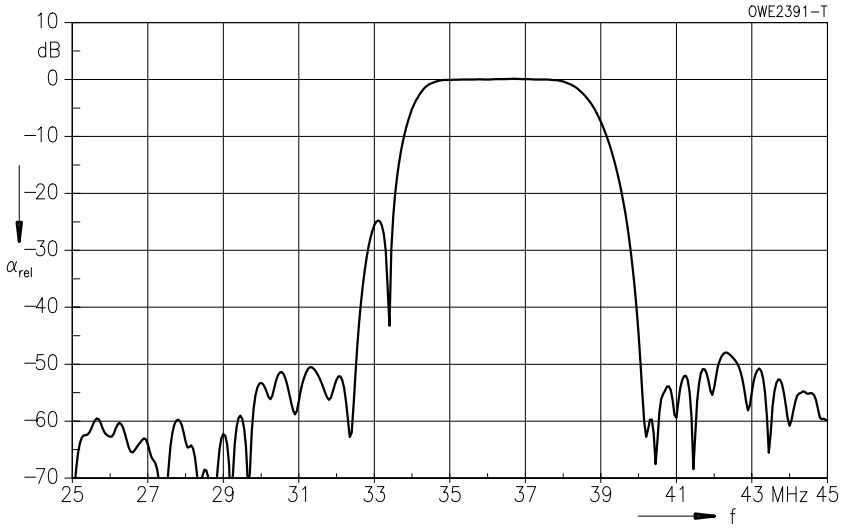

### Standard

- B/G-CCIR  
Germany, Europe partly

### Features

- TV IF filter with Nyquist slope and sound suppression
- Constant group delay
- Suitable for CENELEC EN 55020

### Terminals

- Tinned CuFe alloy

Plastic package **SIP 5 K**

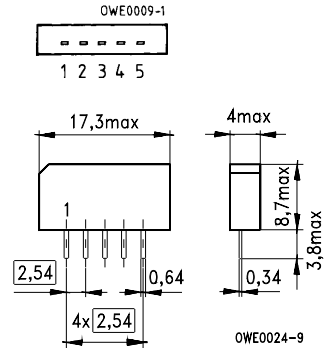

Dimensions in mm, approx. weight 1,0 g

### Pin configuration

- 1 Input
- 2 Input – ground
- 3 Chip carrier – ground
- 4 Output
- 5 Output

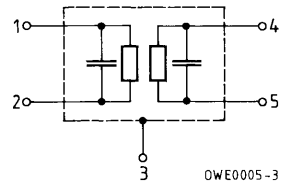

Type	Ordering code	Marking
G 3965 M	B39389-G3965-M100	Type, date code, pin 1

### Maximum ratings

Ambient temperature	$T_A$	- 25/+ 65	°C	—
Storage temperature	$T_{stg}$	- 25/+ 85	°C	—
DC voltage	$V_{DC}$	12	V	between any terminals
AC voltage	$V_{pp}$	10	V	between any terminals

**Characteristics**

Ambient temperature  $T_A = 25\text{ °C}$   
 Source impedance  $Z_S = 50\ \Omega$   
 Load impedance  $Z_L = 2\text{ k}\Omega \parallel 3\text{ pF}$

		min.	typ.	max.		
<b>Insertion attenuation</b>						
Reference level for the following data	37,40 MHz	$\alpha$	13,1	14,6	16,1	dB
<b>Relative attenuation</b>						
Picture carrier	38,90 MHz	$\alpha_{rel}$	4,6	5,3	6,0	dB
Color carrier	34,47 MHz		1,9	2,9	3,9	dB
Sound carrier	33,40 MHz		40,0	51,0	—	dB
Adjacent picture carrier	UHF 30,90 MHz		46,0	54,0	—	dB
	VHF 31,90 MHz		48,0	58,0	—	dB
Adjacent sound carrier	VHF 31,40 MHz		42,0	48,0	—	dB
	VHF 32,40 MHz		46,0	56,0	—	dB
	VHF 40,15 MHz		36,0	54,0	—	dB
Lower sidelobe	UHF 25,00 ... 32,40 MHz		41,0	47,0	—	dB
	UHF 41,40 MHz		44,0	56,0	—	dB
Upper sidelobe	40,40 ... 45,00 MHz		36,0	42,0	—	dB
<b>Reflected wave signal suppression</b>						
1,2 $\mu$ s ... 6,0 $\mu$ s after main pulse (test pulse: 250 ns, carrier frequency: 37,40 MHz)			42,0	52,0	—	dB
<b>Feedthrough signal suppression</b>						
1,3 $\mu$ s ... 1,2 $\mu$ s before main pulse (test pulse: 250 ns, carrier frequency: 37,40 MHz)			50,0	56,0	—	dB
<b>Group delay ripple (p-p)</b>		$\Delta\tau$	—	50	—	ns
<b>Impedance at 37,40 MHz</b>						
Input: $Z_{IN} = R_{IN} \parallel C_{IN}$			—	1,6 $\parallel$ 15,0	—	k $\Omega$ $\parallel$ pF
Output: $Z_{OUT} = R_{OUT} \parallel C_{OUT}$			—	1,3 $\parallel$ 4,8	—	k $\Omega$ $\parallel$ pF
<b>Temperature coefficient of frequency</b>		$TC_f$	—	-72	—	ppm/K

Frequency response

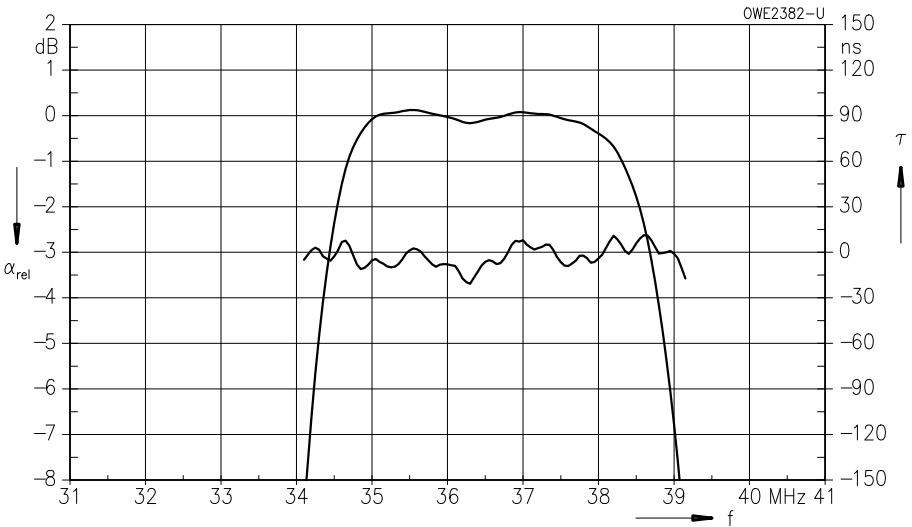
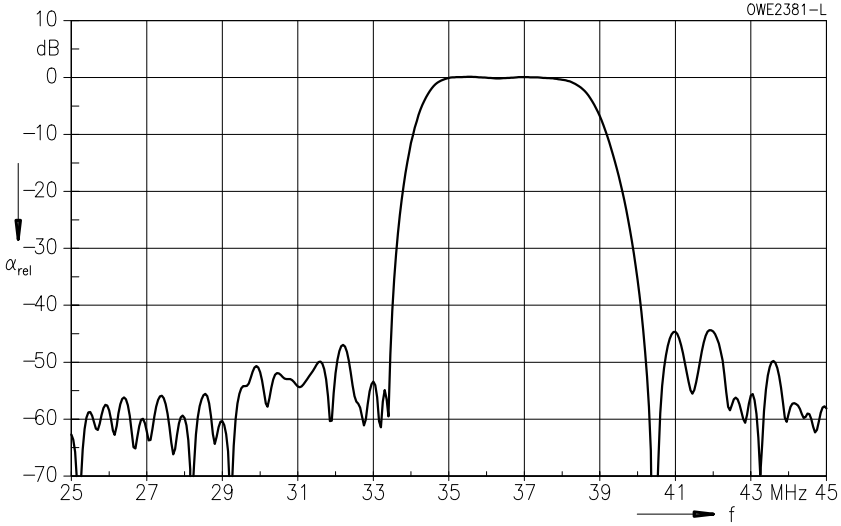

## Standard

- I  
Great Britain

## Features

- TV IF filter for video applications with Nyquist slope and sound suppression
- Constant group delay
- Suitable for CENELEC EN 55020

## Terminals

- Tinned CuFe alloy

Plastic package **SIP 5 K**

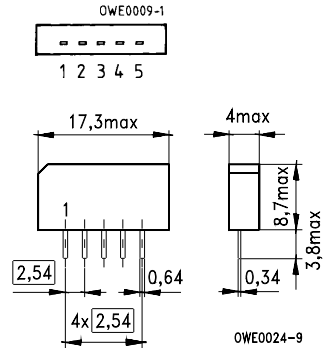

Dimensions in mm, approx. weight 1,0 g

## Pin configuration

- 1 Input
- 2 Input – ground
- 3 Chip carrier – ground
- 4 Output
- 5 Output

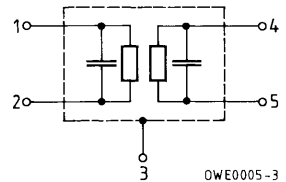

Type	Ordering code	Marking
J 3950 M	B39395-J3950-M100	Type, date code, pin 1

## Maximum ratings

Ambient temperature	$T_A$	- 25/+ 65	°C	—
Storage temperature	$T_{stg}$	- 25/+ 85	°C	—
DC voltage	$V_{DC}$	12	V	between any terminals
AC voltage	$V_{pp}$	10	V	between any terminals

# J 3950 M

## 39,50 MHz

### Characteristics

Ambient temperature	$T_A = 25\text{ °C}$
Source impedance	$Z_S = 50\ \Omega$
Load impedance	$Z_L = 2\text{ k}\Omega \parallel 3\text{ pF}$

		min.	typ.	max.		
<b>Insertion attenuation</b>						
Reference level for the following data	38,00 MHz	$\alpha$	14,2	15,7	17,2	dB
<b>Relative attenuation</b>						
Picture carrier	39,50 MHz	$\alpha_{rel}$	4,5	5,5	6,5	dB
Color carrier	35,07 MHz		1,2	2,2	3,2	dB
Sound carrier	33,50 MHz		43,0	50,0	—	dB
	32,95 MHz		44,0	58,0	—	dB
Adjacent picture carrier	31,50 MHz		48,0	62,0	—	dB
	31,00 MHz		46,0	60,0	—	dB
	32,00 MHz		46,0	60,0	—	dB
Adjacent sound carrier	41,50 MHz		44,0	57,0	—	dB
	40,95 MHz		42,0	54,0	—	dB
Lower sidelobe	25,00 ... 31,50 MHz		42,0	52,0	—	dB
Upper sidelobe	41,50 ... 45,00 MHz		37,0	44,0	—	dB
<b>Reflected wave signal suppression</b>						
1,0 $\mu$ s ... 6,0 $\mu$ s after main pulse (test pulse: 250 ns, carrier frequency: 38,00 MHz)			42,0	57,0	—	dB
<b>Feedthrough signal suppression</b>						
1,1 $\mu$ s ... 1,0 $\mu$ s before main pulse (test pulse: 250 ns, carrier frequency: 38,00 MHz)			50,0	56,0	—	dB
<b>Group delay ripple (p-p)</b>		$\Delta\tau$	—	30	—	ns
<b>Impedance at 38,00 MHz</b>						
Input: $Z_{IN} = R_{IN} \parallel C_{IN}$			—	1,8    12,8	—	k $\Omega$    pF
Output: $Z_{OUT} = R_{OUT} \parallel C_{OUT}$			—	2,7    3,3	—	k $\Omega$    pF
<b>Temperature coefficient of frequency</b>		$TC_f$	—	-72	—	ppm/K



Frequency response

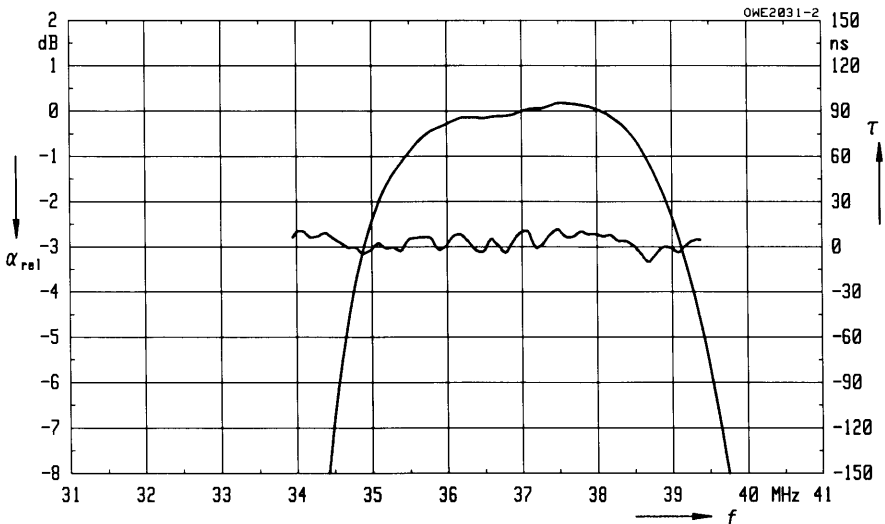
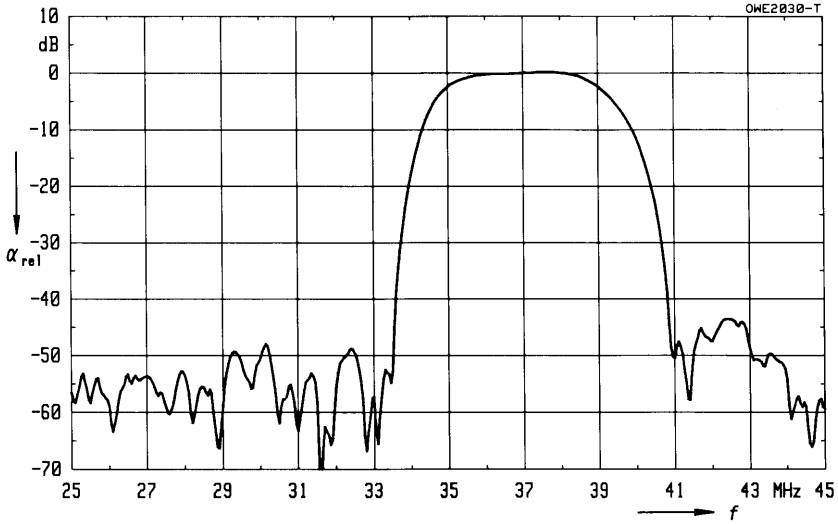

### Standard

- M/N-FCC  
USA

### Features

- TV IF filter with Nyquist slope and sound suppression
- Customized group delay predistortion
- Suitable for FCC EIA/IS-31 regulations

### Terminals

- Tinned CuFe alloy

Plastic package **SIP 5 K**

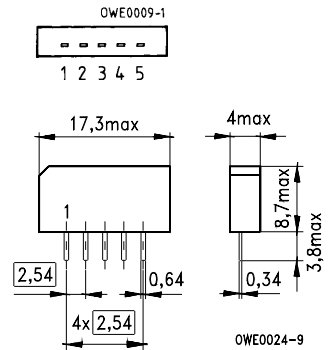

Dimensions in mm, approx. weight 1,0 g

### Pin configuration

- 1 Input
- 2 Input – ground
- 3 Chip carrier – ground
- 4 Output
- 5 Output

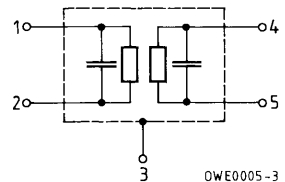

Type	Ordering code	Marking
M 3951 M	B39458-M3951-M100	Type, date code, pin 1

### Maximum ratings

Ambient temperature	$T_A$	- 25/+ 65	°C	—
Storage temperature	$T_{stg}$	- 25/+ 85	°C	—
DC voltage	$V_{DC}$	12	V	between any terminals
AC voltage	$V_{pp}$	10	V	between any terminals

**Characteristics**

Ambient temperature  $T_A = 25 (45) \text{ }^\circ\text{C}$   
 Source impedance  $Z_S = 50 \text{ } \Omega$   
 Load impedance  $Z_L = 2 \text{ k}\Omega \parallel 3 \text{ pF}$

		min.	typ.	max.		
<b>Insertion attenuation</b>						
Reference level for the following data	44,06 (44,00) MHz	$\alpha$	11,0	12,5	14,0	dB
<b>Relative attenuation</b>						
Picture carrier	45,81 (45,75) MHz	$\alpha_{rel}$	4,6	5,6	6,6	dB
Color carrier	42,23 (42,17) MHz		1,2	2,2	3,2	dB
Sound carrier	41,31 (41,25) MHz		25,0	32,0	—	dB
Adjacent picture carrier	39,81 (39,75) MHz		48,0	61,0	—	dB
Adjacent sound carrier	47,31 (47,25) MHz		46,0	56,0	—	dB
Lower sidelobe						
	35,06 ... 39,81 (35,00 ... 39,75) MHz		38,0	42,0	—	dB
Upper sidelobe						
	47,31 ... 55,06 (47,25 ... 55,00) MHz		36,0	41,0	—	dB
<b>Reflected wave signal suppression</b>						
1,1 $\mu\text{s}$ ... 6,0 $\mu\text{s}$ after main pulse (test pulse: 250 ns, carrier frequency: 44,06 MHz)			42,0	52,0	—	dB
<b>Feedthrough signal suppression</b>						
1,2 $\mu\text{s}$ ... 1,1 $\mu\text{s}$ before main pulse (test pulse: 250 ns, carrier frequency: 44,06 MHz)			50,0	56,0	—	dB
<b>Group delay predistortion</b>						
(reference frequency: 45,81 MHz)		$\Delta\tau$				
	42,81 (42,75) MHz		—	- 10	—	ns
	42,23 (42,17) MHz		—	- 40	—	ns
<b>Group delay ripple (p-p)</b>						
		$\Delta\tau$	—	40	—	ns
<b>Impedance at 44,06 MHz</b>						
Input: $Z_{IN} = R_{IN} \parallel C_{IN}$			—	1,4 $\parallel$ 10,8	—	$\text{k}\Omega \parallel \text{pF}$
Output: $Z_{OUT} = R_{OUT} \parallel C_{OUT}$			—	0,9 $\parallel$ 4,4	—	$\text{k}\Omega \parallel \text{pF}$
<b>Temperature coefficient of frequency</b>						
		$TC_f$	—	- 72	—	ppm/K

Frequency response

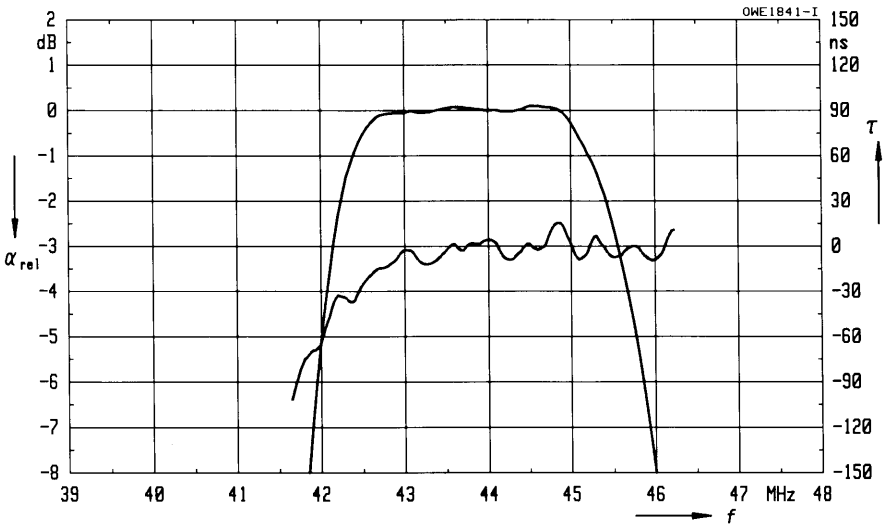
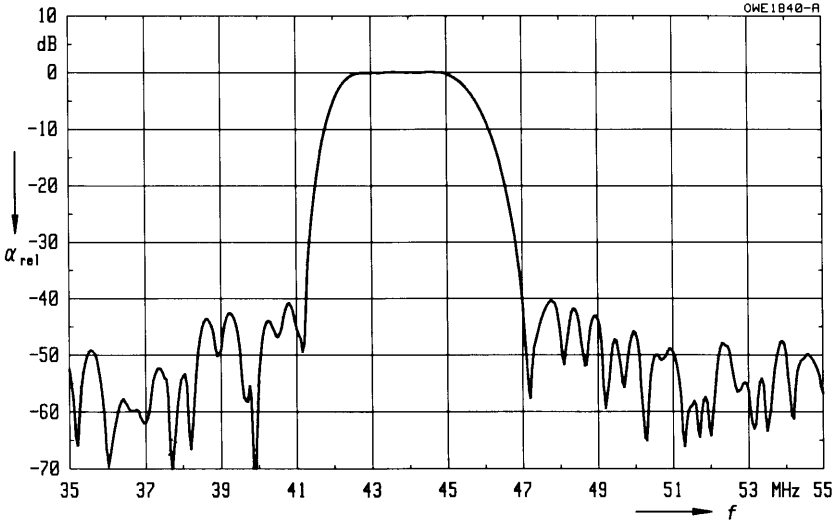

## Standard

- M  
Japan

## Features

- TV IF filter with Nyquist slope and sound suppression
- High color carrier level
- Constant group delay

## Terminals

- Tinned CuFe alloy

Plastic package **SIP 5 K**

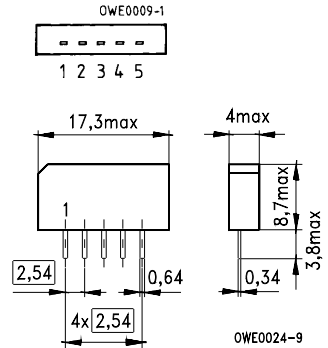

Dimensions in mm, approx. weight 1,0 g

## Pin configuration

- 1 Input
- 2 Input – ground
- 3 Chip carrier – ground
- 4 Output
- 5 Output

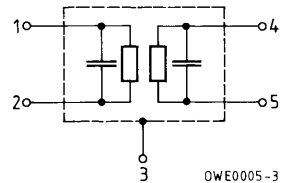

Type	Ordering code	Marking
N 3954 M	B39588-N3954-M100	Type, date code, pin 1

## Maximum ratings

Ambient temperature	$T_A$	- 25/+ 65	°C	—
Storage temperature	$T_{stg}$	- 25/+ 85	°C	—
DC voltage	$V_{DC}$	12	V	between any terminals
AC voltage	$V_{pp}$	10	V	between any terminals

# N 3954 M

## 58,75 MHz

### Characteristics

Ambient temperature	$T_A = 25 (45) \text{ }^\circ\text{C}$
Source impedance	$Z_S = 50 \text{ } \Omega$
Load impedance	$Z_L = 2 \text{ k}\Omega \parallel 3 \text{ pF}$

		min.	typ.	max.		
<b>Insertion attenuation</b>						
Reference level for the following data	57,08 (57,00) MHz	$\alpha$	10,6	12,1	13,6	dB
<b>Relative attenuation</b>						
Picture carrier	58,83 (58,75) MHz	$\alpha_{rel}$	4,9	5,9	6,9	dB
Color carrier	55,25 (55,17) MHz		-0,7	0,3	1,3	dB
Sound carrier	54,33 (54,25) MHz		25,0	40,0	—	dB
Adjacent picture carrier	52,83 (52,75) MHz		44,0	50,0	—	dB
Adjacent sound carrier	60,33 (60,25) MHz		42,0	50,0	—	dB
Lower sidelobe	45,08 ... 52,83 (45,00 ... 52,75) MHz		38,0	44,0	—	dB
Upper sidelobe	60,33 ... 65,08 (60,25 ... 65,00) MHz		38,0	44,0	—	dB
<b>Reflected wave signal suppression</b>						
1,2 $\mu\text{s}$ ... 6,0 $\mu\text{s}$ after main pulse (test pulse: 250 ns, carrier frequency: 57,08 MHz)			42,0	48,0	—	dB
<b>Feedthrough signal suppression</b>						
1,3 $\mu\text{s}$ ... 1,2 $\mu\text{s}$ before main pulse (test pulse: 250 ns, carrier frequency: 57,08 MHz)			50,0	56,0	—	dB
<b>Group delay ripple (p-p)</b>		$\Delta\tau$	—	60	—	ns
<b>Impedance at 57,08 MHz</b>						
Input: $Z_{IN} = R_{IN} \parallel C_{IN}$			—	0,8 $\parallel$ 11,8	—	$\text{k}\Omega \parallel \text{pF}$
Output: $Z_{OUT} = R_{OUT} \parallel C_{OUT}$			—	0,6 $\parallel$ 3,0	—	$\text{k}\Omega \parallel \text{pF}$
<b>Temperature coefficient of frequency</b>		$TC_f$	—	-72	—	ppm/K

Frequency response

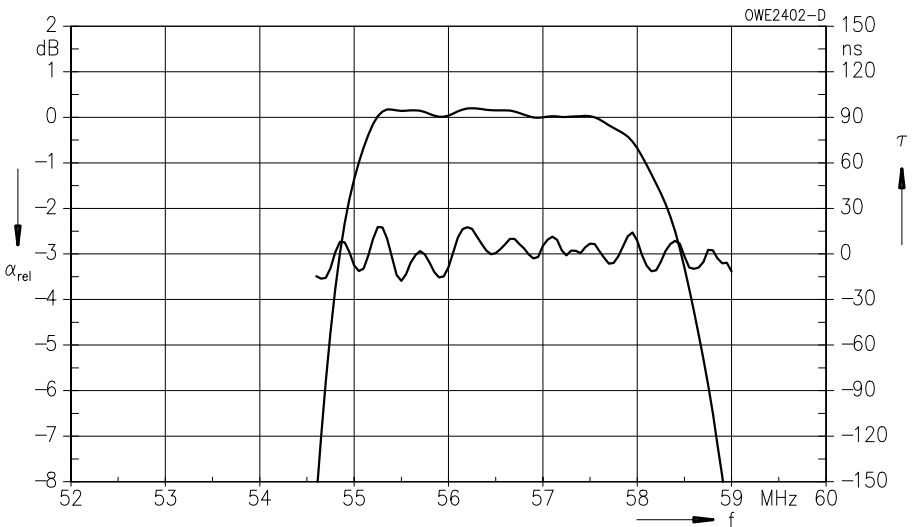
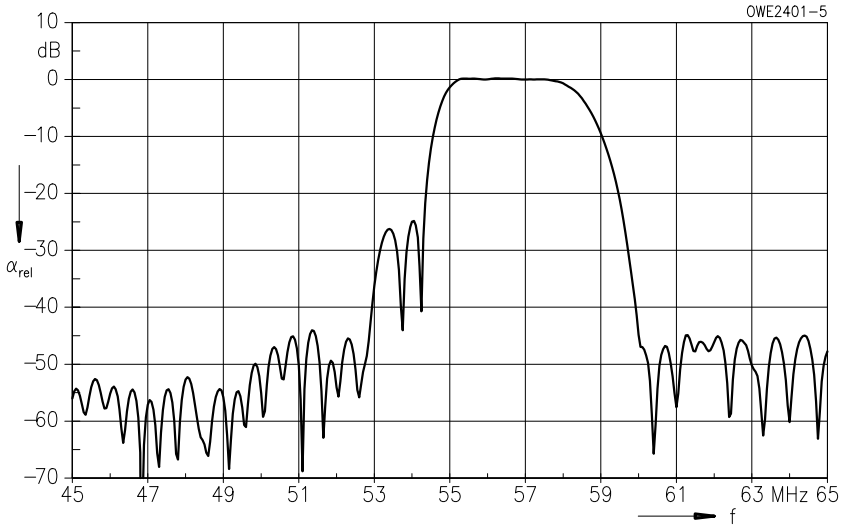



Siemens Matsushita Components

European technology center for  
ceramic components

# There when you need us

This is an organization that's proven its worth. Because it stands for more customer proximity and thus better service. Here you get information straight from the source, implementation of the latest technologies and products that match the market. Concentration of resources means that design engineers and production engineers are working side by side. And SCS warehousing directly at the plant ensures fastest possible delivery.



**SCS – dependable, fast and competent**

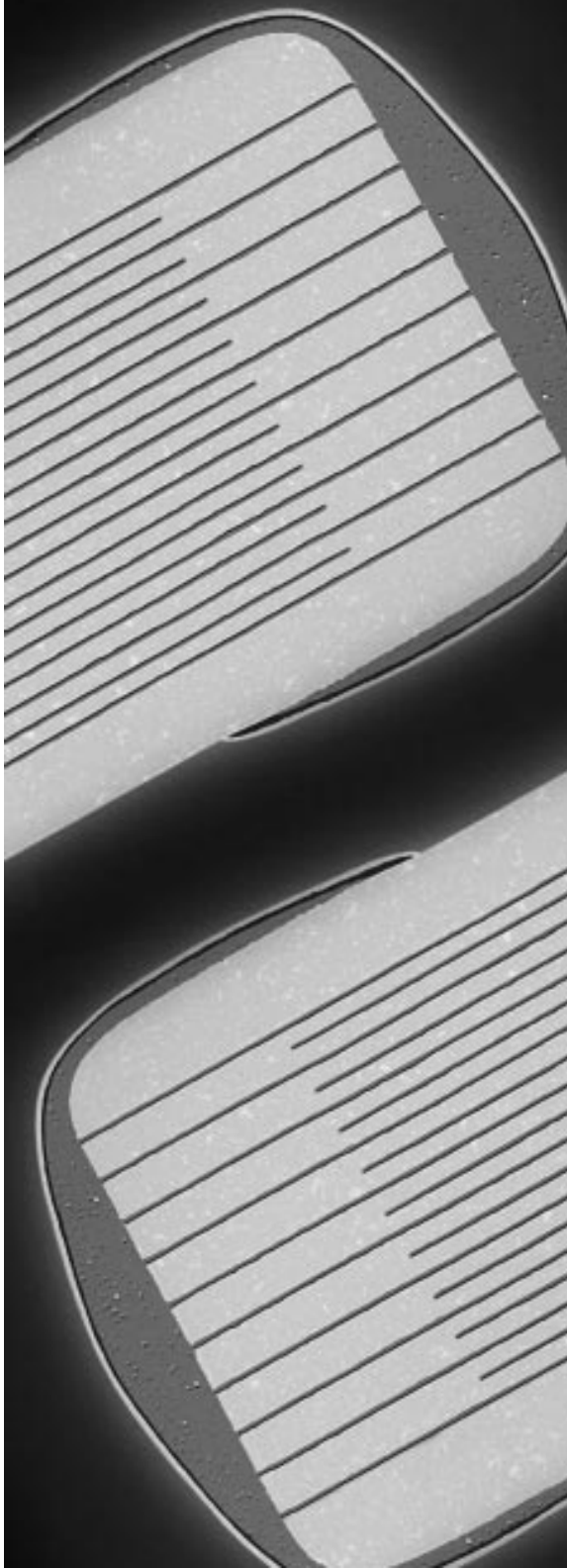



# IF Filters for Audio Applications

## Survey

Sound carrier MHz	Picture-to- sound carrier distance MHz	Picture carrier level <sup>1)</sup> dB	Standard <sup>2)</sup>	Package	Type	Page <sup>3)</sup>
31,50 ... 32,50	5,5 ... 6,5	- 56 <sup>4)</sup>	D/K, I, B/G	SIP 5 K <sup>5)</sup>	K 9455 M	<a href="#">219</a>
31,50 ... 33,50	4,5 ... 6,5	0	D/K, I, B/G, M/N	SIP 5 K	K 9252 M	#
	4,5 ... 6,5	- 52 <sup>4)</sup>	D/K, I, B/G, M/N	SIP 5 K	K 9352 M	#
32,40	6,5	- 48 <sup>4)</sup>	L	SIP 5 K	L 9360 M	#
	6,5	- 49 <sup>4)</sup>	L	SIP 5 K	L 9362 M	<a href="#">223</a>
	6,5	- 45 <sup>4)</sup>	L	SIP 5 K <sup>5)</sup>	L 9453 M	#
	6,5	- 57 <sup>4)</sup>	L NICAM	SIP 5 K <sup>5)</sup>	L 9454 M	<a href="#">225</a>
	6,5	- 45 <sup>4)</sup>	L NICAM	SIP 5 K <sup>5)</sup>	L 9455 M	#
	6,5	- 48 <sup>4)</sup>	L	SIP 5 K <sup>5)</sup>	L 9456 M	<a href="#">228</a>
	6,5	- 54 <sup>4)</sup>	L	SIP 5 K <sup>5)</sup>	L 9460 M	#
	6,5	- 50 <sup>4)</sup>	L	SIP 5 K <sup>5)</sup>	L 9461 M	#
32,40 ... 32,90	6,0 ... 6,5	- 50 <sup>4)</sup>	D/K, L, I	SIP 5 K <sup>5)</sup>	K 9460 M	#
	6,0 ... 6,5	- 49 <sup>4)</sup>	D/K, L, I NICAM	SIP 5 K <sup>5)</sup>	K 9463 M	#
32,40 ... 33,40	5,5 ... 6,5	0	D/K, I, B/G	SIP 5 K	K 9260 M	<a href="#">231</a>
	5,5 ... 6,5	- 51 <sup>4)</sup>	D/K, L, I, B/G	SIP 5 K	K 9350 M	#
	5,5 ... 6,5	- 49 <sup>4)</sup>	D/K, L, I, B/G	SIP 5 K <sup>5)</sup>	K 9453 M	<a href="#">233</a>
	5,5 ... 6,5	- 42 <sup>4)</sup>	D/K, L, I, B/G	SIP 5 K <sup>5)</sup>	K 9462 M	#
32,40 ... 34,40	4,5 ... 6,5	0	D/K, I, B/G, M/N	SIP 5 K	K 9253 M	#
32,90	6,0	- 47 <sup>4)</sup>	I NICAM	DIP 10 K	K 4350 K	#
	6,0	- 57 <sup>4)</sup>	I NICAM	SIP 5 K	K 9353 M	#
33,40	5,5	0	B/G NICAM	SIP 5 K	G 9251 M	#
	5,5	- 55 <sup>4)</sup>	B/G, L NICAM	SIP 5 K	G 9353 M	<a href="#">237</a>
	5,5	- 54 <sup>4)</sup>	B/G, L NICAM	DIP 10 K	K 4350 K	#
	5,5	- 56 <sup>4)</sup>	B/G, L NICAM	SIP 5 K <sup>5)</sup>	K 9460 M	#
	5,5	- 44 <sup>4)</sup>	B/G, L NICAM	SIP 5 K <sup>5)</sup>	K 9463 M	#
33,50	6,0	0	I NICAM	SIP 5 K	J 9250 M	#
	4,5	- 56 <sup>4)</sup>	M/N	SIP 5 K <sup>5)</sup>	K 9455 M	<a href="#">219</a>
34,40	4,5	- 41 <sup>4)</sup>	M/N	SIP 5 K <sup>5)</sup>	K 9461 M	#
	4,5	- 48 <sup>4)</sup>	M/N	SIP 5 K <sup>5)</sup>	K 9462 M	#
39,20	- 6,5	- 60 <sup>4)</sup>	L	SIP 5 K	L 9361 M	#

continued on next page

1) Typ., referred to filter roof

2) For explanation of standards see individual data sheets or index on page [349](#)

3) Filters marked by the sign # are only listed in the survey. Detailed information on these types on request.

4) Only sound transmission

5) Pin configuration different from standard package

## IF Filters for Audio Applications

### Survey

Sound carrier MHz	Picture-to- sound carrier distance MHz	Picture carrier level <sup>1)</sup> dB	Standard <sup>2)</sup>	Package	Type	Page <sup>3)</sup>
39,90	- 6,5	- 51 <sup>4)</sup>	L NICAM	SIP 5 K <sup>5)</sup>	L 9455 M	#
	- 6,5	- 42 <sup>4)</sup>	L	SIP 5 K <sup>5)</sup>	L 9460 M	#
40,40	- 6,5	- 55 <sup>4)</sup>	L	SIP 5 K	L 9353 M	#
	- 6,5	- 62 <sup>4)</sup>	L NICAM	SIP 5 K	L 9354 M	#
	- 6,5	- 52 <sup>4)</sup>	L	SIP 5 K <sup>5)</sup>	L 9453 M	#
	- 6,5	- 50 <sup>4)</sup>	L NICAM	SIP 5 K <sup>5)</sup>	L 9454 M	<a href="#">225</a>
	- 6,5	- 50 <sup>4)</sup>	L	SIP 5 K <sup>5)</sup>	L 9456 M	<a href="#">228</a>
	- 6,5	- 52 <sup>4)</sup>	L	SIP 5 K <sup>5)</sup>	K 9453 M	<a href="#">233</a>
	- 6,5	- 52 <sup>4)</sup>	L	SIP 5 K <sup>5)</sup>	K 9461 M	#
41,00	- 6,5	- 52 <sup>4)</sup>	L	SIP 5 K <sup>5)</sup>	L 9461 M	#
41,25	4,5	0	M/N	SIP 5 K	M 9260 M	<a href="#">240</a>
	4,5	- 59 <sup>4)</sup>	M/N	SIP 5 K	M 9352 M	<a href="#">242</a>
54,25	4,5	0	M	SIP 5 K	N 9260 M	#
	4,5	- 50 <sup>4)</sup>	M	SIP 5 K	N 9350 M	<a href="#">245</a>

1) Typ., referred to filter roof

2) For explanation of standards see individual data sheets or index on page [349](#)

3) Filters marked by the sign # are only listed in the survey. Detailed information on these types on request.

4) Only sound transmission

5) Pin configuration different from standard package

## Standard

- D/K-OIRT  
Eastern Standard
- I  
Great Britain
- B/G-CCIR  
Europe partly
- M/N-FCC  
USA

## Features

- TV IF audio filter with two channels
- Channel 1 (B/G, D/K, I) with pass band for sound carriers between 31,95 MHz and 32,50 MHz
- Channel 2 (M/N) with pass band for sound carrier at 33,50 MHz

## Terminals

- Tinned CuFe alloy

## Pin configuration

- 1 Input – channel 1 / Input – ground
- 2 Input – ground / Input – channel 2
- 3 Chip carrier – ground
- 4 Output
- 5 Output

Plastic package **SIP 5 K**

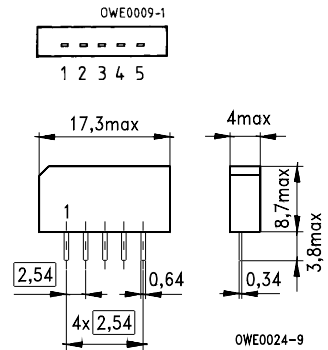

Dimensions in mm, approx. weight 1,0 g

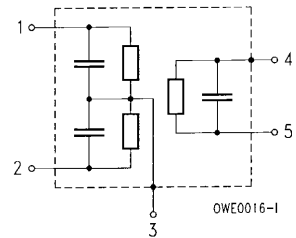

Type	Ordering code	Marking
K 9455 M	B39380-K9455-M100	Type, date code, pin 1

## Maximum ratings

Ambient temperature	$T_A$	- 25/+ 65	°C	—
Storage temperature	$T_{stg}$	- 25/+ 85	°C	—
DC voltage	$V_{DC}$	12	V	between any terminals
AC voltage	$V_{pp}$	10	V	between any terminals

# K 9455 M

## 38,00 MHz

### Characteristics of channel 1

Ambient temperature  $T_A = 25\text{ °C}$   
 Source impedance  $Z_S = 50\ \Omega$   
 Load impedance  $Z_L = 2\text{ k}\Omega \parallel 3\text{ pF}$

		min.	typ.	max.	
<b>Insertion attenuation</b>	$\alpha$				
Reference level for the following data	32,50 MHz	12,6	14,1	15,6	dB
<b>Relative attenuation</b>	$\alpha_{rel}$				
Sound carrier	31,45 MHz	- 1,8	- 0,8	0,2	dB
	31,50 MHz	- 1,8	- 0,8	0,2	dB
	32,00 MHz	- 1,2	- 0,2	0,8	dB
Picture carrier	38,00 MHz	44,0	56,0	—	dB
Color carrier	33,57 MHz	32,0	48,0	—	dB
Adjacent picture carrier	30,00 MHz	42,0	56,0	—	dB
Adjacent sound carrier	39,50 MHz	42,0	54,0	—	dB
	40,00 MHz	40,0	46,0	—	dB
	40,50 MHz	39,0	45,0	—	dB
Lower sidelobe	25,00 ... 30,00 MHz	36,0	42,0	—	dB
Upper sidelobe	38,00 ... 45,00 MHz	38,0	44,0	—	dB
<b>Impedance at 32,50 MHz</b>					
Input: $Z_{IN} = R_{IN} \parallel C_{IN}$		—	1,1 $\parallel$ 10,8	—	k $\Omega$ $\parallel$ pF
Output: $Z_{OUT} = R_{OUT} \parallel C_{OUT}$		—	1,0 $\parallel$ 6,3	—	k $\Omega$ $\parallel$ pF
<b>Temperature coefficient of frequency</b>	$TC_f$	—	- 72	—	ppm/K

**Frequency response**

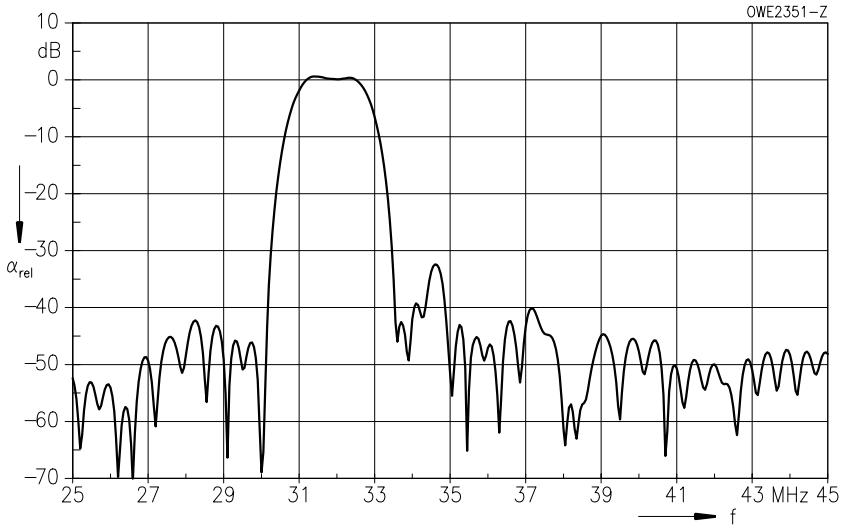

# K 9455 M

## 38,00 MHz

### Characteristics of channel 2

Ambient temperature  $T_A = 25\text{ °C}$   
 Source impedance  $Z_S = 50\ \Omega$   
 Load impedance  $Z_L = 2\text{ k}\Omega \parallel 3\text{ pF}$

		min.	typ.	max.	
<b>Insertion attenuation</b>					
	$\alpha$				
Reference level for the following data	33,50 MHz	12,8	14,3	15,8	dB
<b>Relative attenuation</b>					
	$\alpha_{rel}$				
Picture carrier	38,00 MHz	42,0	56,0	—	dB
Color carrier	34,42 MHz	30,0	41,0	—	dB
Adjacent picture carrier	32,00 MHz	40,0	54,0	—	dB
Adjacent sound carrier	39,50 MHz	42,0	56,0	—	dB
Lower sidelobe	25,00 ... 32,00 MHz	25,0	30,0	—	dB
Upper sidelobe	38,00 ... 45,00 MHz	35,0	41,0	—	dB
<b>Impedance at 33,50 MHz</b>					
	Input: $Z_{IN} = R_{IN} \parallel C_{IN}$	—	0,6 $\parallel$ 13,4	—	k $\Omega$ $\parallel$ pF
	Output: $Z_{OUT} = R_{OUT} \parallel C_{OUT}$	—	1,4 $\parallel$ 5,4	—	k $\Omega$ $\parallel$ pF
<b>Temperature coefficient of frequency</b>					
	$TC_f$	—	-72	—	ppm/K

### Frequency response

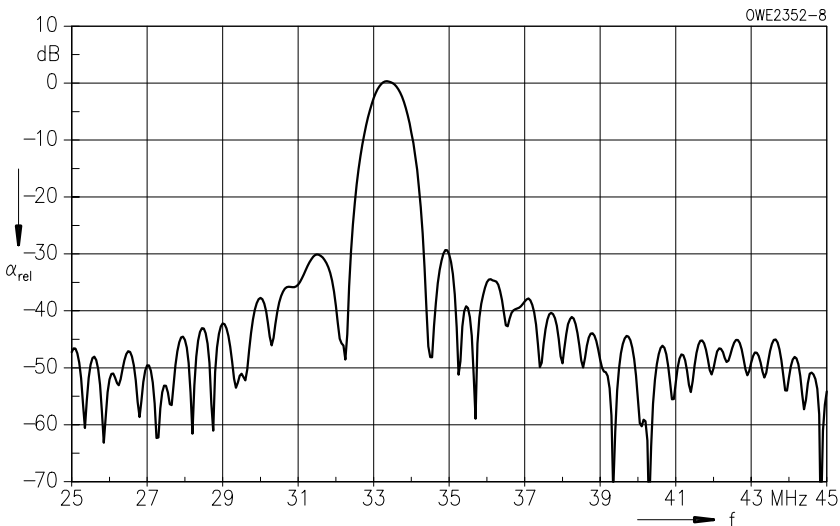

### Standard

- L  
France

### Features

- TV IF audio filter with pass band for sound carrier at 32,40 MHz
- Highly suppressed NICAM sound carrier

### Terminals

- Tinned CuFe alloy

Plastic package **SIP 5 K**

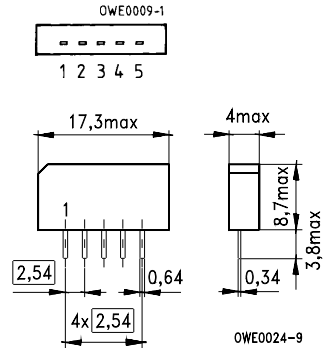

Dimensions in mm, approx. weight 1,0 g

### Pin configuration

- 1 Input
- 2 Input – ground
- 3 Chip carrier – ground
- 4 Output
- 5 Output

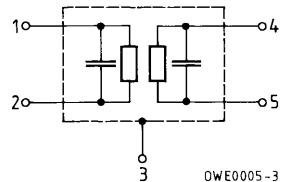

Type	Ordering code	Marking
L 9362 M	B39389-L9362-M100	Type, date code, pin 1

### Maximum ratings

Ambient temperature	$T_A$	- 25/+ 65	°C	—
Storage temperature	$T_{stg}$	- 25/+ 85	°C	—
DC voltage	$V_{DC}$	12	V	between any terminals
AC voltage	$V_{pp}$	10	V	between any terminals

# L 9362 M

## 38,90 MHz

### Characteristics

Ambient temperature  $T_A = 25\text{ °C}$   
 Source impedance  $Z_S = 50\ \Omega$   
 Load impedance  $Z_L = 2\text{ k}\Omega \parallel 3\text{ pF}$

		min.	typ.	max.	
<b>Insertion attenuation</b>	$\alpha$				
Reference level for the following data	32,40 MHz	4,0	5,5	7,0	dB
<b>Relative attenuation</b>	$\alpha_{rel}$				
Picture carrier	38,90 MHz	43,0	49,0	—	dB
NICAM sound carrier	33,05 MHz	17,0	20,0	—	dB
	34,47 MHz	38,0	57,0	—	dB
Adjacent picture carrier	30,90 MHz	42,0	51,0	—	dB
Adjacent sound carrier	40,40 MHz	50,0	67,0	—	dB
Lower sidelobe	25,00 ... 30,90 MHz	33,0	37,0	—	dB
Upper sidelobe	38,90 ... 45,00 MHz	42,0	49,0	—	dB
<b>Impedance at 32,40 MHz</b>					
Input: $Z_{IN} = R_{IN} \parallel C_{IN}$		—	0,2 $\parallel$ 11,6	—	k $\Omega$ $\parallel$ pF
Output: $Z_{OUT} = R_{OUT} \parallel C_{OUT}$		—	2,6 $\parallel$ 3,4	—	k $\Omega$ $\parallel$ pF
<b>Temperature coefficient of frequency</b>	$TC_f$	—	-72	—	ppm/K

### Frequency response

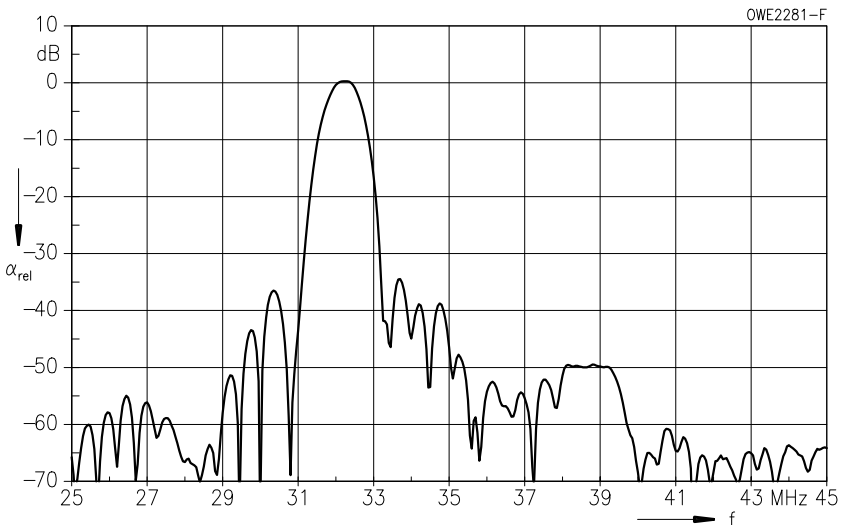



## Standard

- L, L'
- France

## Features

- TV IF audio filter with two channels
- Channel 1 with pass band for sound carriers at 40,40 MHz (L') and 39,75 MHz (L' NICAM)
- Channel 2 with pass band for sound carriers at 32,40 MHz (L) and 33,05 MHz (L NICAM)

## Terminals

- Tinned CuFe alloy

Plastic package **SIP 5 K**

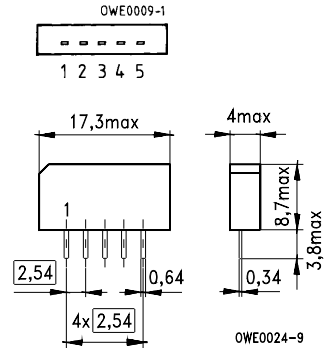

Dimensions in mm, approx. weight 1,0 g

## Pin configuration

- 1 Input – channel 1 / Input – ground
- 2 Input – ground / Input – channel 2
- 3 Chip carrier – ground
- 4 Output
- 5 Output

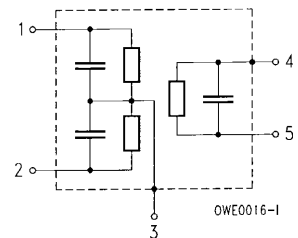

Type	Ordering code	Marking
L 9454 M	B39389-L9454-M100	Type, date code, pin 1

## Maximum ratings

Ambient temperature	$T_A$	- 25/+ 65	°C	—
Storage temperature	$T_{stg}$	- 25/+ 85	°C	—
DC voltage	$V_{DC}$	12	V	between any terminals
AC voltage	$V_{pp}$	10	V	between any terminals

# L 9454 M

## 33,90/38,90 MHz

### Characteristics of channel 1

Ambient temperature  $T_A = 25\text{ °C}$   
 Source impedance  $Z_S = 50\ \Omega$   
 Load impedance  $Z_L = 2\text{ k}\Omega \parallel 3\text{ pF}$

		min.	typ.	max.	
<b>Insertion attenuation</b>	$\alpha$				
Reference level for the following data	40,40 MHz	14,0	15,5	17,0	dB
<b>Relative attenuation</b>	$\alpha_{rel}$				
	39,75 MHz	-1,3	-0,3	0,7	dB
	38,40 MHz	27,0	37,0	—	dB
Picture carrier	33,90 MHz	40,0	50,0	—	dB
Adjacent picture carrier	41,90 MHz	31,0	37,0	—	dB
Adjacent sound carrier	32,40 MHz	36,0	43,0	—	dB
Lower sidelobe	25,00 ... 33,90 MHz	33,0	39,0	—	dB
Upper sidelobe	41,90 ... 45,00 MHz	30,0	37,0	—	dB
<b>Group delay ripple (p-p)</b>	$\Delta\tau$	—	50	—	ns
<b>Impedance at 40,40 MHz</b>					
Input:	$Z_{IN} = R_{IN} \parallel C_{IN}$	—	0,8 $\parallel$ 10,2	—	k $\Omega$ $\parallel$ pF
Output:	$Z_{OUT} = R_{OUT} \parallel C_{OUT}$	—	2,5 $\parallel$ 5,0	—	k $\Omega$ $\parallel$ pF
<b>Temperature coefficient of frequency</b>	$TC_f$	—	-72	—	ppm/K

### Frequency response

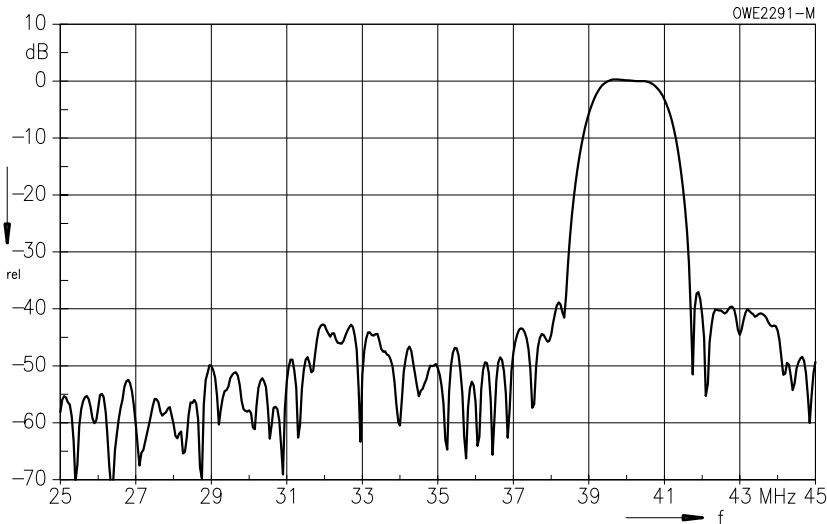

**Characteristics of channel 2**

Ambient temperature  $T_A = 25\text{ °C}$   
 Source impedance  $Z_S = 50\ \Omega$   
 Load impedance  $Z_L = 2\text{ k}\Omega \parallel 3\text{ pF}$

		min.	typ.	max.	
<b>Insertion attenuation</b>	$\alpha$				
Reference level for the following data	32,40 MHz	13,1	14,6	16,1	dB
<b>Relative attenuation</b>	$\alpha_{rel}$				
	33,05 MHz	- 0,7	0,3	1,3	dB
	34,40 MHz	27,0	34,0	—	dB
Picture carrier	38,90 MHz	40,0	57,0	—	dB
Adjacent picture carrier	30,90 MHz	37,0	47,0	—	dB
Adjacent sound carrier	40,40 MHz	37,0	43,0	—	dB
Lower sidelobe	25,00 ... 30,90 MHz	37,0	45,0	—	dB
Upper sidelobe	38,90 ... 45,00 MHz	34,0	39,0	—	dB
<b>Group delay ripple (p-p)</b>	$\Delta\tau$	—	50	—	ns
<b>Impedance at 32,40 MHz</b>					
Input:	$Z_{IN} = R_{IN} \parallel C_{IN}$	—	1,5 $\parallel$ 10,3	—	k $\Omega$ $\parallel$ pF
Output:	$Z_{OUT} = R_{OUT} \parallel C_{OUT}$	—	1,9 $\parallel$ 6,4	—	k $\Omega$ $\parallel$ pF
<b>Temperature coefficient of frequency</b>	$TC_f$	—	- 72	—	ppm/K

**Frequency response**

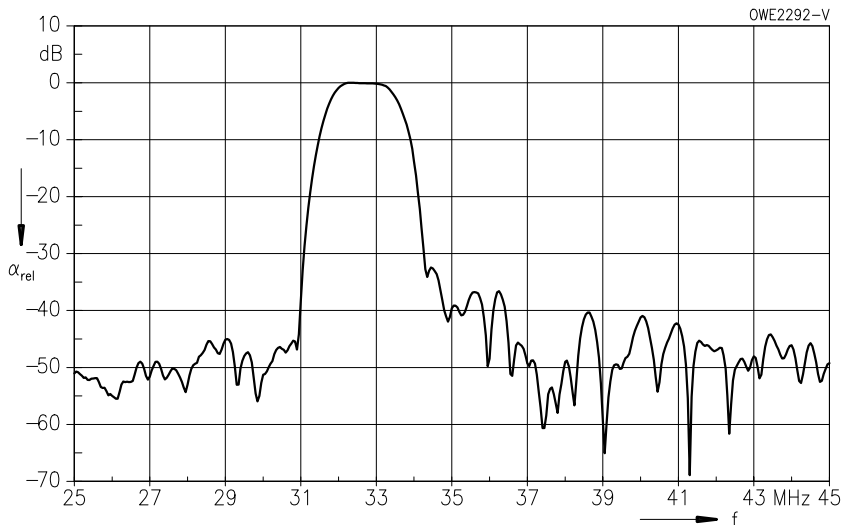

## Standard

- L, L'
- France

## Features

- TV IF audio filter with two channels
- Channel 1 (L') with pass band for sound carrier at 40,40 MHz
- Channel 2 (L) with pass band for sound carrier at 32,40 MHz

## Terminals

- Tinned CuFe alloy

Plastic package **SIP 5 K**

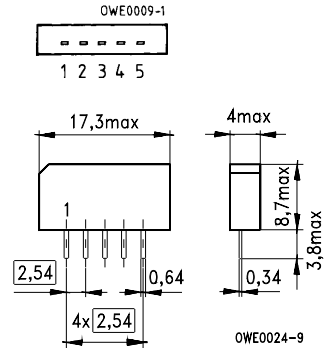

Dimensions in mm, approx. weight 1,0 g

## Pin configuration

- 1 Input – channel 1
- 2 Input – channel 2
- 3 Chip carrier – ground
- 4 Output
- 5 Output

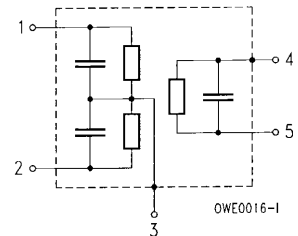

Type	Ordering code	Marking
L 9456 M	B39389-L9456-M100	Type, date code, pin 1

## Maximum ratings

Ambient temperature	$T_A$	- 25/+ 65	°C	—
Storage temperature	$T_{stg}$	- 25/+ 85	°C	—
DC voltage	$V_{DC}$	12	V	between any terminals
AC voltage	$V_{pp}$	10	V	between any terminals

**Characteristics of channel 1**

Ambient temperature  $T_A = 25\text{ }^\circ\text{C}$   
 Source impedance  $Z_S = 50\ \Omega$   
 Load impedance  $Z_L = 2\ \text{k}\Omega \parallel 3\ \text{pF}$

		min.	typ.	max.	
<b>Insertion attenuation</b>					
	$\alpha$				
Reference level for the following data	40,40 MHz	12,6	14,1	15,6	dB
<b>Relative attenuation</b>					
	$\alpha_{rel}$				
NICAM sound carrier	39,75 MHz	12,0	18,0	—	dB
Picture carrier	33,90 MHz	42,0	50,0	—	dB
Adjacent picture carrier	41,90 MHz	34,0	42,0	—	dB
Adjacent sound carrier	32,40 MHz	39,0	48,0	—	dB
Lower sidelobe	25,00 ... 38,40 MHz	33,0	38,0	—	dB
Upper sidelobe	41,90 ... 45,00 MHz	32,0	38,0	—	dB
<b>Impedance at 40,40 MHz</b>					
Input:	$Z_{IN} = R_{IN} \parallel C_{IN}$	—	0,9 $\parallel$ 10,8	—	k $\Omega$ $\parallel$ pF
Output:	$Z_{OUT} = R_{OUT} \parallel C_{OUT}$	—	1,5 $\parallel$ 7,2	—	k $\Omega$ $\parallel$ pF
<b>Temperature coefficient of frequency</b>					
	$TC_f$	—	-72	—	ppm/K

**Frequency response**

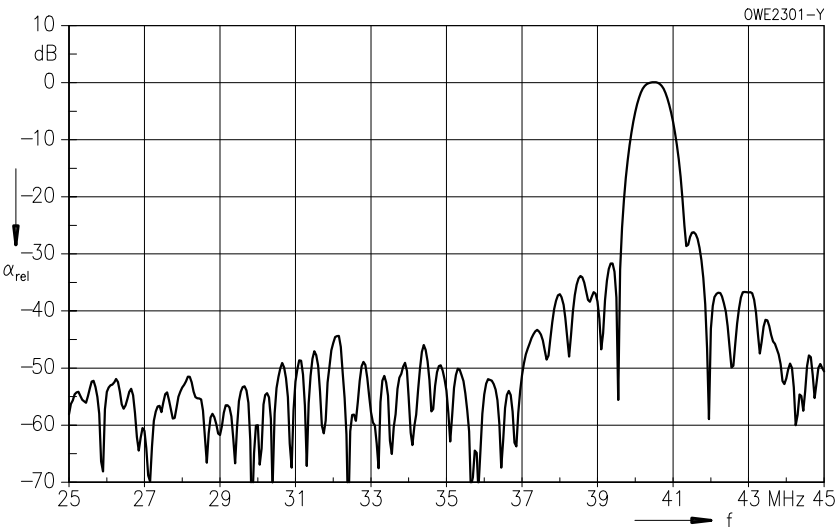

# L 9456 M

## 33,90/38,90 MHz

### Characteristics of channel 2

Ambient temperature  $T_A = 25\text{ °C}$   
 Source impedance  $Z_S = 50\ \Omega$   
 Load impedance  $Z_L = 2\text{ k}\Omega \parallel 3\text{ pF}$

		min.	typ.	max.	
<b>Insertion attenuation</b>					
	$\alpha$				
Reference level for the following data	32,40 MHz	12,8	14,3	15,8	dB
<b>Relative attenuation</b>					
	$\alpha_{rel}$				
NICAM sound carrier	33,05 MHz	15,0	20,0	—	dB
Picture carrier	38,90 MHz	38,0	48,0	—	dB
Adjacent picture carrier	30,90 MHz	38,0	52,0	—	dB
Adjacent sound carrier	40,40 MHz	36,0	41,0	—	dB
Lower sidelobe	25,00 ... 30,90 MHz	33,0	38,0	—	dB
Upper sidelobe	34,40 ... 45,00 MHz	32,0	38,0	—	dB
<b>Impedance at 32,40 MHz</b>					
	Input: $Z_{IN} = R_{IN} \parallel C_{IN}$	—	1,1 $\parallel$ 9,5	—	k $\Omega$ $\parallel$ pF
	Output: $Z_{OUT} = R_{OUT} \parallel C_{OUT}$	—	2,8 $\parallel$ 6,5	—	k $\Omega$ $\parallel$ pF
<b>Temperature coefficient of frequency</b>					
	$TC_f$	—	-72	—	ppm/K

### Frequency response

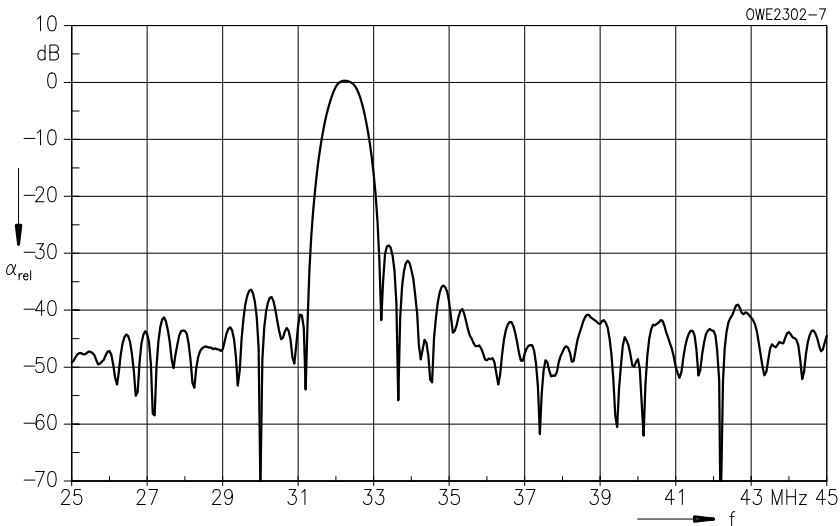

## Standard

- D/K-OIRT  
Eastern Standard
- I  
Great Britain
- B/G-CCIR  
Europe partly

## Features

- TV IF audio filter with pass bands for picture carrier and sound carriers between 31,95 MHz and 33,40 MHz

## Terminals

- Tinned CuFe alloy

Plastic package **SIP 5 K**

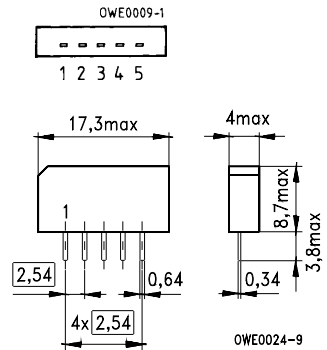

Dimensions in mm, approx. weight 1,0 g

## Pin configuration

- 1 Input
- 2 Input – ground
- 3 Chip carrier – ground
- 4 Output
- 5 Output

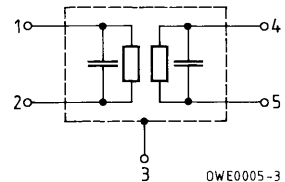

Type	Ordering code	Marking
K 9260 M	B39389-K9260-M100	Type, date code, pin 1

## Maximum ratings

Ambient temperature	$T_A$	- 25/+ 65	°C	—
Storage temperature	$T_{stg}$	- 25/+ 85	°C	—
DC voltage	$V_{DC}$	12	V	between any terminals
AC voltage	$V_{pp}$	10	V	between any terminals

# K 9260 M

## 38,90 MHz

### Characteristics

Ambient temperature  $T_A = 25\text{ °C}$   
 Source impedance  $Z_S = 50\ \Omega$   
 Load impedance  $Z_L = 2\text{ k}\Omega \parallel 3\text{ pF}$

		min.	typ.	max.	
<b>Insertion attenuation</b>	$\alpha$				
Reference level for the following data	38,90 MHz	16,8	18,3	19,8	dB
<b>Relative attenuation</b>	$\alpha_{rel}$				
Sound carrier	32,90 MHz	-0,9	0,1	1,1	dB
	32,35 MHz	-1,4	-0,4	0,6	dB
	33,40 MHz	-0,9	0,1	1,1	dB
Color carrier	34,47 MHz	25,0	32,0	—	dB
Adjacent picture carrier	30,90 MHz	37,0	45,0	—	dB
Adjacent sound carrier	40,90 MHz	38,0	51,0	—	dB
	40,35 MHz	35,0	48,0	—	dB
Lower sidelobe	25,00 ... 30,90 MHz	32,0	38,0	—	dB
Upper sidelobe	38,90 ... 45,00 MHz	32,0	38,0	—	dB
<b>Impedance at 38,90 MHz</b>					
Input: $Z_{IN} = R_{IN} \parallel C_{IN}$		—	2,0 $\parallel$ 10,6	—	k $\Omega$ $\parallel$ pF
Output: $Z_{OUT} = R_{OUT} \parallel C_{OUT}$		—	3,8 $\parallel$ 3,6	—	k $\Omega$ $\parallel$ pF
<b>Temperature coefficient of frequency</b>	$TC_f$	—	-72	—	ppm/K

### Frequency response

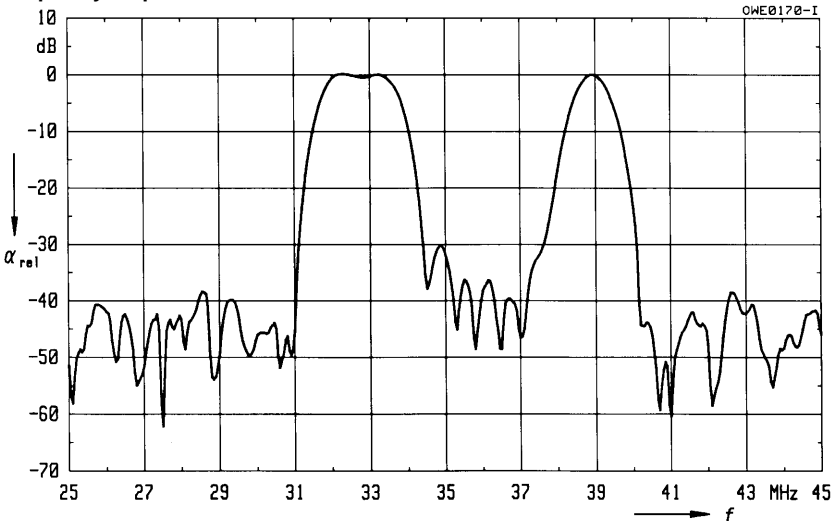



### Standard

- L/L' France
- D/K-OIRT Eastern Standard
- I Great Britain
- B/G-CCIR Europe partly

### Features

- TV IF audio filter with two channels
- Channel 1 (L') with pass band for sound carrier at 40,40 MHz
- Channel 2 (L, D/K, I, B/G) with pass band for sound carriers between 32,40 MHz and 33,40 MHz

### Terminals

- Tinned CuFe alloy

### Pin configuration

- 1 Input – channel 1 / Input – ground
- 2 Input – ground / Input – channel 2
- 3 Chip carrier – ground
- 4 Output
- 5 Output

Plastic package **SIP 5 K**

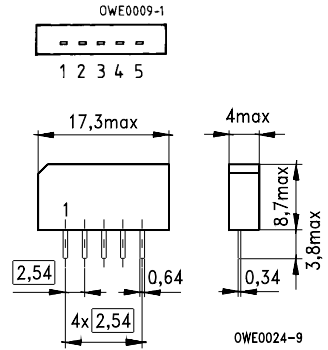

Dimensions in mm, approx. weight 1,0 g

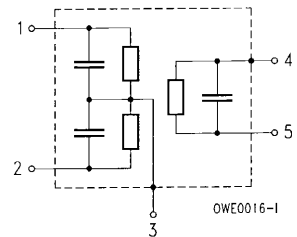

Type	Ordering code	Marking
K 9453 M	B39389-K9453-M100	Type, date code, pin 1

### Maximum ratings

Ambient temperature	$T_A$	- 25/+ 65	°C	—
Storage temperature	$T_{stg}$	- 25/+ 85	°C	—
DC voltage	$V_{DC}$	12	V	between any terminals
AC voltage	$V_{pp}$	10	V	between any terminals

# K 9453 M

## 33,90/38,90 MHz

### Characteristics of channel 1

Ambient temperature  $T_A = 25\text{ °C}$   
 Source impedance  $Z_S = 50\ \Omega$   
 Load impedance  $Z_L = 2\text{ k}\Omega \parallel 3\text{ pF}$

		min.	typ.	max.	
<b>Insertion attenuation</b>					
	$\alpha$				
Reference level for the following data	40,40 MHz	12,0	13,5	15,0	dB
<b>Relative attenuation</b>					
	$\alpha_{rel}$				
Picture carrier	33,90 MHz	42,0	52,0		dB
	38,40 MHz	40,0	56,0		dB
Adjacent picture carrier	41,90 MHz	36,0	44,0	—	dB
Adjacent sound carrier	32,40 MHz	42,0	50,0	—	dB
Lower sidelobe	25,00 ... 38,40 MHz	38,0	46,0	—	dB
Upper sidelobe	41,90 ... 45,00 MHz	32,0	38,0	—	dB
<b>Impedance at 40,40 MHz</b>					
	Input: $Z_{IN} = R_{IN} \parallel C_{IN}$	—	0,8 $\parallel$ 8,5	—	k $\Omega$ $\parallel$ pF
	Output: $Z_{OUT} = R_{OUT} \parallel C_{OUT}$	—	2,1 $\parallel$ 5,3	—	k $\Omega$ $\parallel$ pF
<b>Temperature coefficient of frequency</b>					
	$TC_f$	—	-72	—	ppm/K

### Frequency response

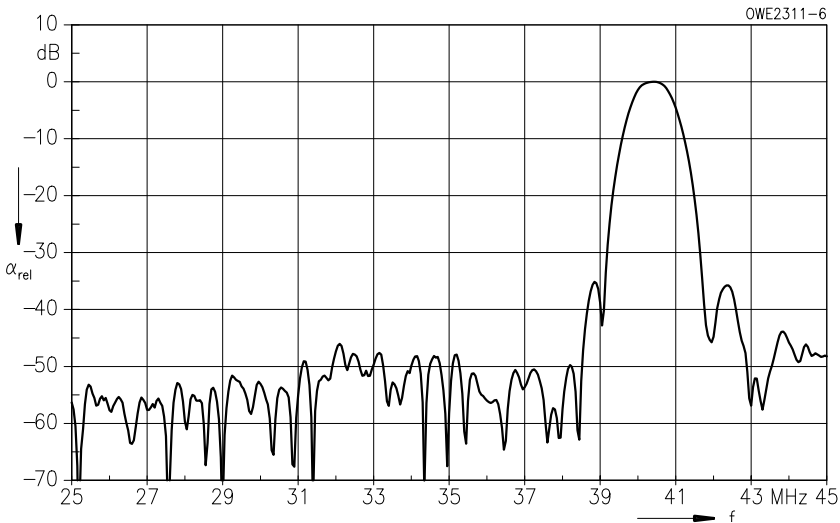

**Characteristics of channel 2**

Ambient temperature  $T_A = 25\text{ °C}$   
 Source impedance  $Z_S = 50\ \Omega$   
 Load impedance  $Z_L = 2\text{ k}\Omega \parallel 3\text{ pF}$

		min.	typ.	max.	
<b>Insertion attenuation</b>					
	$\alpha$				
Reference level for the following data	33,40 MHz	13,0	14,5	16,0	dB
<b>Relative attenuation</b>					
	$\alpha_{rel}$				
Sound carrier	33,05 MHz	- 1,3	- 0,3	0,7	dB
	32,90 MHz	- 0,9	0,1	1,1	dB
	32,40 MHz	- 1,2	- 0,2	0,8	dB
	38,90 MHz	39,0	49,0	—	dB
Color carrier	34,47 MHz	25,0	32,0	—	dB
Adjacent picture carrier	30,90 MHz	31,0	37,0	—	dB
Adjacent sound carrier	40,40 MHz	34,0	40,0	—	dB
	40,90 MHz	36,0	43,0	—	dB
	41,40 MHz	38,0	48,0	—	dB
Lower sidelobe	25,00 ... 30,50 MHz	38,0	44,0	—	dB
Upper sidelobe	38,90 ... 45,00 MHz	32,0	37,0	—	dB
<b>Impedance at 33,40 MHz</b>					
	Input: $Z_{IN} = R_{IN} \parallel C_{IN}$	—	1,0 $\parallel$ 10,1	—	k $\Omega$ $\parallel$ pF
	Output: $Z_{OUT} = R_{OUT} \parallel C_{OUT}$	—	2,7 $\parallel$ 6,8	—	k $\Omega$ $\parallel$ pF
<b>Temperature coefficient of frequency</b>					
	$TC_f$	—	- 72	—	ppm/K

Frequency response curve on next page

**K 9453 M**  
**33,90/38,90 MHz**

---

**Frequency response**

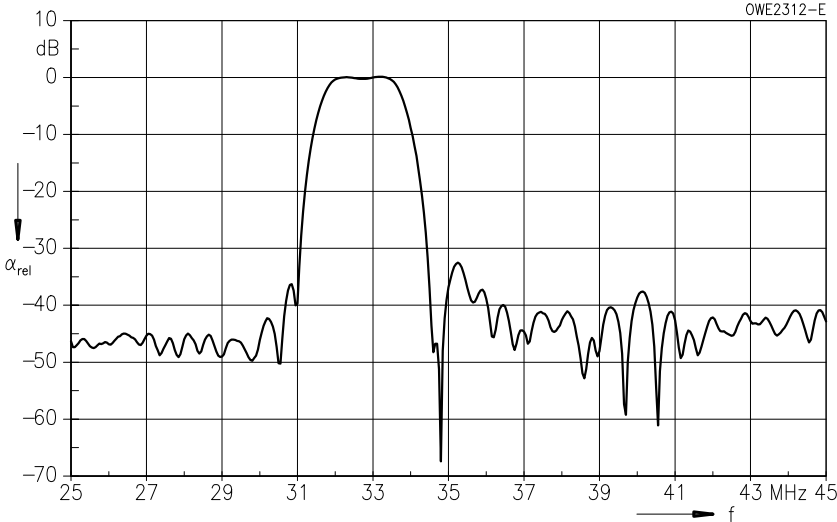

### Standard

- B/G-CCIR  
Germany, Europe partly
- L  
France

### Features

- TV IF audio filter with pass band for sound carriers at 33,40 MHz (B/G) and 33,05 MHz (B/G, L NICAM)

### Terminals

- Tinned CuFe alloy

Plastic package **SIP 5 K**

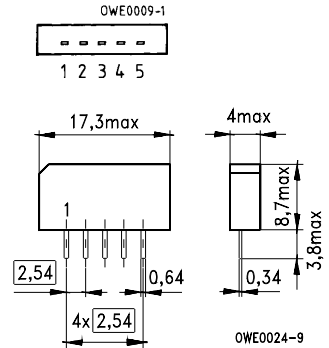

Dimensions in mm, approx. weight 1,0 g

### Pin configuration

- 1 Input
- 2 Input ground
- 3 Chip carrier – ground
- 4 Output
- 5 Output

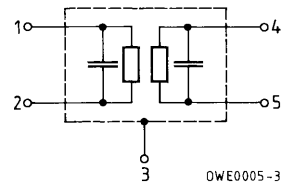

Type	Ordering code	Marking
G 9353 M	B39389-G9353-M100	Type, date code, pin 1

### Maximum ratings

Ambient temperature	$T_A$	- 25/+ 65	°C	—
Storage temperature	$T_{stg}$	- 25/+ 85	°C	—
DC voltage	$V_{DC}$	12	V	between any terminals
AC voltage	$V_{pp}$	10	V	between any terminals

# G 9353 M

## 38,90 MHz

### Characteristics

Ambient temperature  $T_A = 25\text{ °C}$   
 Source impedance  $Z_S = 50\ \Omega$   
 Load impedance  $Z_L = 2\text{ k}\Omega \parallel 3\text{ pF}$

		min.	typ.	max.	
<b>Insertion attenuation</b>	$\alpha$				
Reference level for the following data	33,05 MHz	12,1	13,6	15,1	dB
<b>Relative attenuation</b>	$\alpha_{rel}$				
Sound carrier	33,40 MHz	0,4	1,4	2,4	dB
	32,80 MHz	—	0,9	—	dB
Picture carrier	38,90 MHz	40,0	55,0	—	dB
Color carrier	34,47 MHz	26,0	34,0	—	dB
Adjacent picture carrier	UHF 30,90 MHz	31,0	36,0	—	dB
	VHF 31,90 MHz	33,0	41,0	—	dB
Adjacent sound carrier	VHF 40,40 MHz	40,0	55,0	—	dB
	UHF 41,40 MHz	40,0	56,0	—	dB
Lower sidelobe	25,00 ... 31,90 MHz	30,0	36,0	—	dB
Upper sidelobe	40,40 ... 45,00 MHz	37,0	46,0	—	dB
<b>Group delay ripple (p-p)</b>	$\Delta\tau$	—	40	—	ns
<b>Impedance</b> at 33,05 MHz					
Input:	$Z_{IN} = R_{IN} \parallel C_{IN}$	—	1,2 $\parallel$ 10,3	—	k $\Omega$ $\parallel$ pF
Output:	$Z_{OUT} = R_{OUT} \parallel C_{OUT}$	—	3,4 $\parallel$ 2,9	—	k $\Omega$ $\parallel$ pF
<b>Temperature coefficient of frequency</b>	$TC_f$	—	-72	—	ppm/K

Frequency response

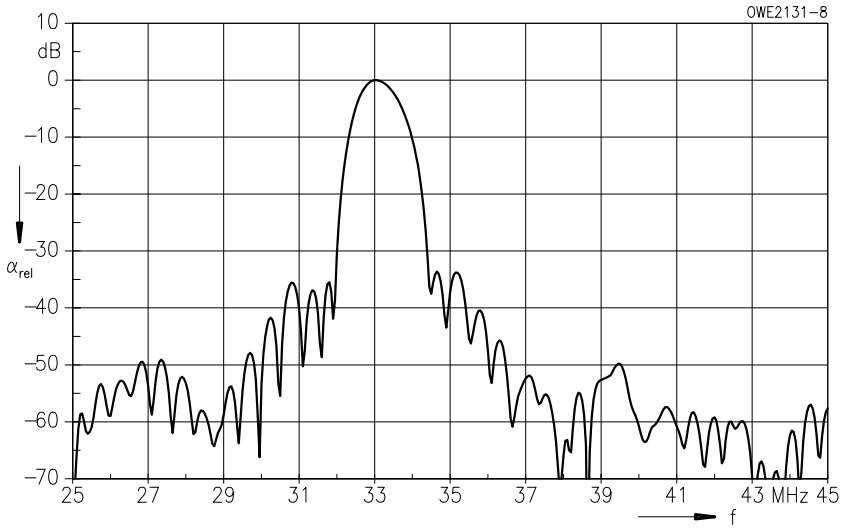

### Standard

- M/N-FCC  
USA

### Features

- TV IF audio filter with pass bands for picture carrier and sound carrier at 41,25 MHz

### Terminals

- Tinned CuFe alloy

Plastic package **SIP 5 K**

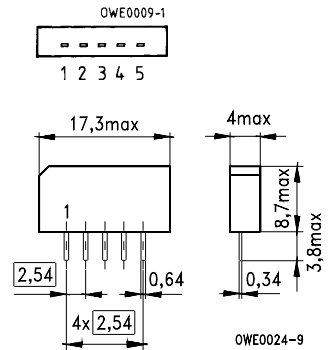

Dimensions in mm, approx. weight 1,0 g

### Pin configuration

- 1 Input
- 2 Input – ground
- 3 Chip carrier – ground
- 4 Output
- 5 Output

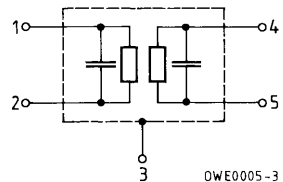

Type	Ordering code	Marking
M 9260 M	B39458-M9260-M100	Type, date code, pin 1

### Maximum ratings

Ambient temperature	$T_A$	- 25/+ 65	°C	—
Storage temperature	$T_{stg}$	- 25/+ 85	°C	—
DC voltage	$V_{DC}$	12	V	between any terminals
AC voltage	$V_{pp}$	10	V	between any terminals



**Characteristics**

Ambient temperature  $T_A = 25\text{ °C}$   
 Source impedance  $Z_S = 50\ \Omega$   
 Load impedance  $Z_L = 2\text{ k}\Omega \parallel 3\text{ pF}$

		min.	typ.	max.	
<b>Insertion attenuation</b>	$\alpha$				
Reference level for the following data	41,25 MHz	12,9	14,4	15,9	dB
<b>Relative attenuation</b>	$\alpha_{rel}$				
Picture carrier	45,75 MHz	- 1,0	0,0	1,0	dB
Color carrier	42,17 MHz	22,0	28,0	—	dB
Adjacent picture carrier	39,75 MHz	42,0	50,0	—	dB
Adjacent sound carrier	47,25 MHz	40,0	48,0	—	dB
Lower sidelobe	35,00 ... 39,75 MHz	40,0	46,0	—	dB
Upper sidelobe	47,25 ... 55,00 MHz	36,0	42,0	—	dB
<b>Impedance at 41,25 MHz</b>					
Input: $Z_{IN} = R_{IN} \parallel C_{IN}$		—	0,4 $\parallel$ 9,5	—	k $\Omega$ $\parallel$ pF
Output: $Z_{OUT} = R_{OUT} \parallel C_{OUT}$		—	3,3 $\parallel$ 6,3	—	k $\Omega$ $\parallel$ pF
<b>Temperature coefficient of frequency</b>	$TC_f$	—	- 72	—	ppm/K

**Frequency response**

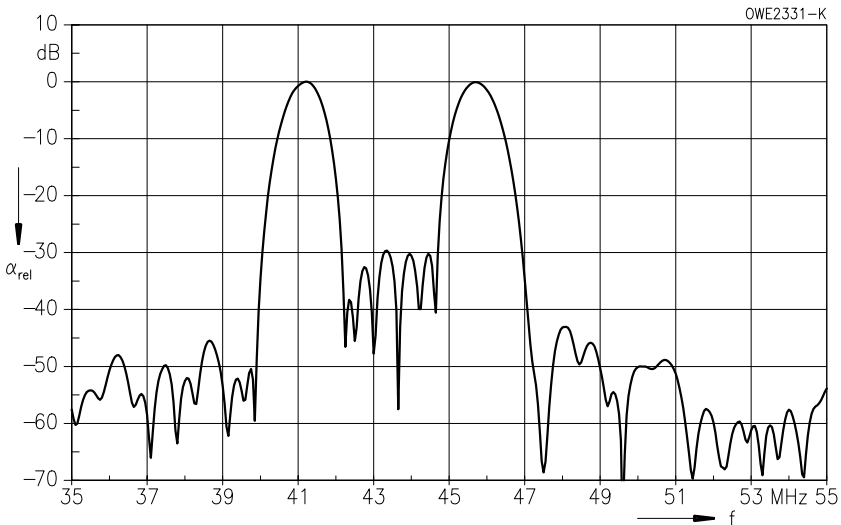

### Standard

- M/N-FCC  
USA

### Features

- TV IF audio filter with pass band for sound carrier at 41,25 MHz

### Terminals

- Tinned CuFe alloy

Plastic package **SIP 5 K**

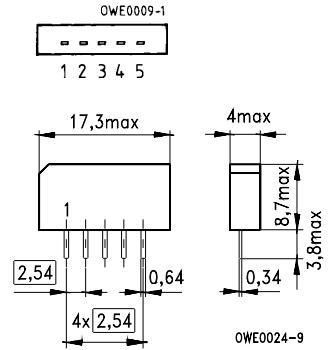

Dimensions in mm, approx. weight 1,0 g

### Pin configuration

- 1 Input
- 2 Input – ground
- 3 Chip carrier – ground
- 4 Output
- 5 Output

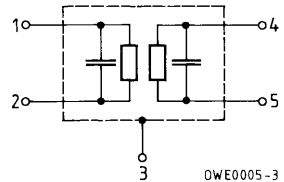

Type	Ordering code	Marking
M 9352 M	B39458-M9352-M100	Type, date code, pin 1

### Maximum ratings

Ambient temperature	$T_A$	- 25/+ 65	°C	—
Storage temperature	$T_{stg}$	- 25/+ 85	°C	—
DC voltage	$V_{DC}$	12	V	between any terminals
AC voltage	$V_{pp}$	10	V	between any terminals

**Characteristics**

Ambient temperature  $T_A = 25\text{ °C}$   
 Source impedance  $Z_S = 50\ \Omega$   
 Load impedance  $Z_L = 50\ \Omega$

		min.	typ.	max.	
<b>Insertion attenuation</b>	$\alpha$				
Reference level for the following data	41,25 MHz	17,0	18,5	20,0	dB
<b>Relative attenuation</b>	$\alpha_{rel}$				
	40,95 MHz	0,5	1,5	2,5	dB
	41,55 MHz	-0,3	0,7	1,7	dB
	39,17 MHz	40,0	54,0	—	dB
Picture carrier	45,75 MHz	46,0	59,0	—	dB
Color carrier	42,17 MHz	20,0	28,0	—	dB
Adjacent picture carrier	39,75 MHz	40,0	45,0	—	dB
Adjacent sound carrier	47,25 MHz	46,0	62,0	—	dB
Lower sidelobe	35,00 ... 39,75 MHz	36,0	41,0	—	dB
Upper sidelobe	45,75 ... 55,00 MHz	42,0	52,0	—	dB
<b>Group delay ripple (p-p)</b>	$\Delta\tau$	—	90	—	ns
<b>Impedance at 41,25 MHz</b>					
Input: $Z_{IN} = R_{IN} \parallel C_{IN}$		—	0,1    24,2	—	k $\Omega$    pF
Output: $Z_{OUT} = R_{OUT} \parallel C_{OUT}$		—	1,2    8,3	—	k $\Omega$    pF
<b>Temperature coefficient of frequency</b>	$TC_f$	—	-72	—	ppm/K

Frequency response curve on next page

**M 9352 M**  
**45,75 MHz**

---

**Frequency response**

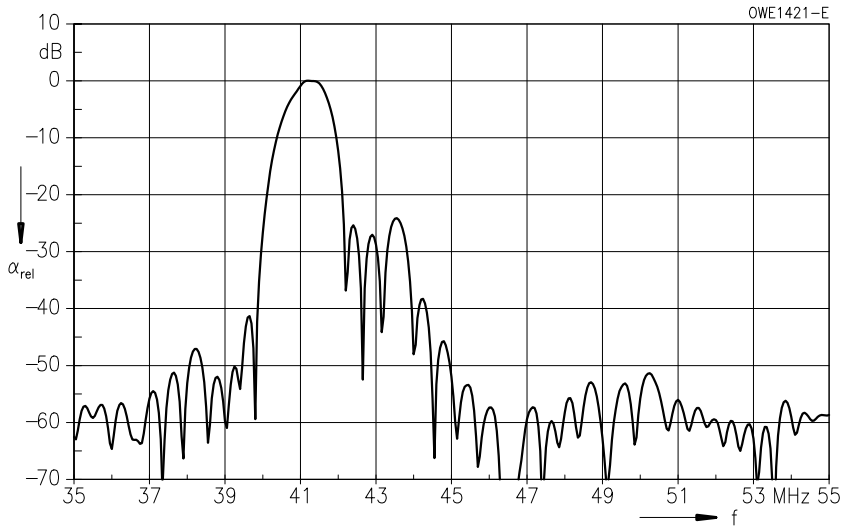

### Standard

- M  
Japan

### Features

- TV IF audio filter with pass band for sound carrier at 54,25 MHz

### Terminals

- Tinned CuFe alloy

Plastic package **SIP 5 K**

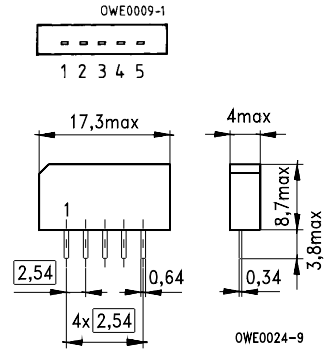

Dimensions in mm, approx. weight 1,0 g

### Pin configuration

- 1 Input
- 2 Input – ground
- 3 Chip carrier – ground
- 4 Output
- 5 Output

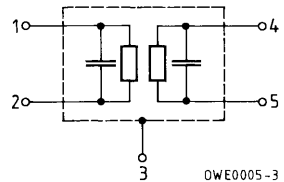

Type	Ordering code	Marking
N 9350 M	B39588-N9350-M100	Type, date code, pin 1

### Maximum ratings

Ambient temperature	$T_A$	- 25/+ 65	°C	—
Storage temperature	$T_{stg}$	- 25/+ 85	°C	—
DC voltage	$V_{DC}$	12	V	between any terminals
AC voltage	$V_{pp}$	10	V	between any terminals

# N 9350 M

## 58,75 MHz

### Characteristics

Ambient temperature  $T_A = 25 (45) \text{ }^\circ\text{C}$   
 Source impedance  $Z_S = 50 \text{ } \Omega$   
 Load impedance  $Z_L = 2 \text{ k}\Omega \parallel 3 \text{ pF}$

		min.	typ.	max.	
<b>Insertion attenuation</b>					
Reference level for the following data	54,33 (54,25) MHz $\alpha$	14,7	16,2	17,7	dB
<b>Relative attenuation</b>					
Picture carrier	58,83 (58,75) MHz $\alpha_{rel}$	38,0	50,0	—	dB
Color carrier	55,25 (55,17) MHz	26,0	32,0	—	dB
Adjacent picture carrier	52,83 (52,75) MHz	38,0	48,0	—	dB
Adjacent sound carrier	60,33 (60,25) MHz	42,0	54,0	—	dB
Lower sidelobe					
45,08 ... 52,83 (45,00 ... 52,75) MHz		30,0	36,0	—	dB
Upper sidelobe					
60,33 ... 65,08 (60,25 ... 65,00) MHz		40,0	48,0	—	dB
<b>Impedance at 54,33 MHz</b>					
Input: $Z_{IN} = R_{IN} \parallel C_{IN}$		—	0,8 $\parallel$ 8,6	—	k $\Omega$ $\parallel$ pF
Output: $Z_{OUT} = R_{OUT} \parallel C_{OUT}$		—	2,7 $\parallel$ 2,1	—	k $\Omega$ $\parallel$ pF
<b>Temperature coefficient of frequency</b>	$TC_f$	—	-72	—	ppm/K

### Frequency response

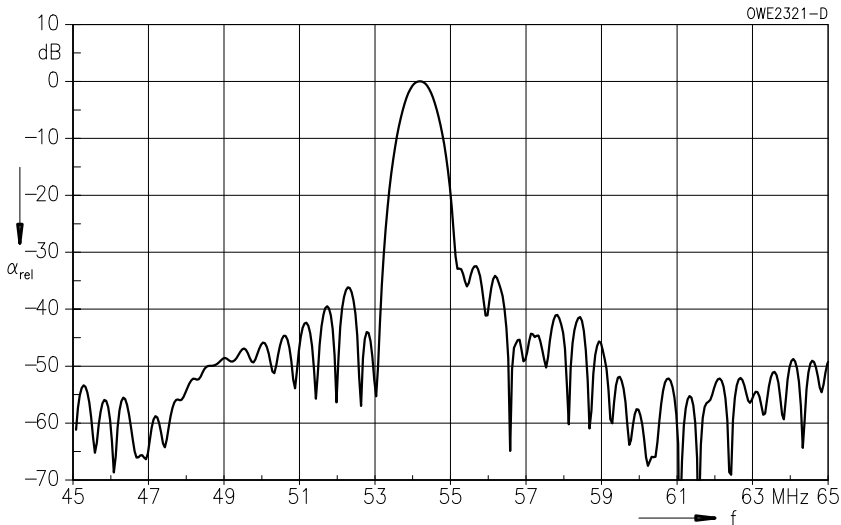

## Satellite Filters

### Survey

Center frequency MHz	3 dB bandwidth MHz	Insertion attenuation dB	Shunt resistors <sup>1)</sup>	Package	Type	Page <sup>2)</sup>
402,78	27,0 + 31,0	24,7 + 23,4	no	TO 39	B 609	<a href="#">248</a>
403,18	26,9 + 32,1 31,3	24,8 + 24,8 22,0	yes	TO 39	B 629	#
			no	TO 39	B 682	<a href="#">253</a>
479,50	27,0 + 18,0 27,0 + 32,0 27,0 + 36,0 21,5 + 27,0 15,0 + 27,0	20,4 + 21,0 21,3 + 21,3 22,1 + 22,7 21,0 + 21,0 21,8 + 22,0	no	TO 39	B 611	<a href="#">256</a>
			no	TO 39	B 615	#
			no	TO 39	B 619	#
			no	TO 39	B 621	#
			no	TO 39	B 625	#
480,00	33,5 + 36,1 15,7 32,0 22,5 36,2 26,6 17,6 26,6	23,2 + 22,2 18,4 20,0 19,0 21,0 20,0 19,5 18,5	yes	TO 39	B 635	<a href="#">261</a>
			yes	TO 39	B 662	#
			no	TO 39	B 674	#
			no	TO 39	B 680	#
			no	TO 39	B 686	#
			yes	TO 39	B 692	<a href="#">266</a>
			yes	TO 39	B 694	<a href="#">269</a>
			no	TO 39	B 696	#

1) Integrated shunt resistors for improved ESD capability

2) Filters marked by the sign # are only listed in the survey. Detailed information on these types upon request.

## Features

- Two-channel satellite receiver filter
- IF filter for DSB receivers
- Constant group delay

## Terminals

- Gold-plated NiFeCo alloy

Metal package TO 39

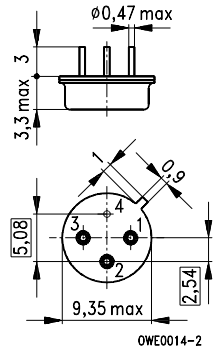

Dimensions in mm, approx. weight 1,0 g

## Pin configuration

- 1 Input
- 2 Output – channel 2
- 3 Output – channel 1
- 4 Ground

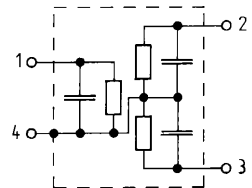

OWE0013-T

Type	Ordering code	Marking
B 609	B39401-B609-B210	Type, date code

Electrostatic Sensitive Device (ESD)

## Maximum ratings

Ambient temperature	$T_A$	- 20/+ 80	°C	—
Storage temperature	$T_{stg}$	- 25/+ 85	°C	—
DC voltage	$V_{DC}$	0	V	between any terminals
AC voltage	$V_{pp}$	5	V	between any terminals



**Characteristics of channel 1**

Ambient temperature  $T_A = 25\text{ °C}$   
 Source impedance  $Z_S = 50\ \Omega$   
 Load impedance  $Z_L = 50\ \Omega$   
 Group delay aperture 0,25 MHz

				min.	typ.	max.	
<b>Insertion attenuation</b>	402,78 MHz	$\alpha$	—	24,7	26,0	dB	
Reference level for the following data							
<b>Pass bandwidth</b> ( $\alpha_{rel} \leq 3\text{ dB}$ )		$B_{3dB}$	—	27,00	—	MHz	
<b>Relative attenuation</b>		$\alpha_{rel}$					
	389,28 MHz		—	3,4	4,0	dB	
	416,28 MHz		—	2,4	4,0	dB	
Lower sidelobe	350,00 ... 372,78 MHz		30,0	42,0	—	dB	
Upper sidelobe	432,78 ... 450,00 MHz		30,0	42,5	—	dB	
<b>Reflected wave signal suppression</b>							
0,06 $\mu$ s ... 3,0 $\mu$ s after main pulse			40,0	52,0	—	dB	
<b>Amplitude</b>							
Amplitude ripple (p-p) 397,78 ... 407,78 MHz		$\Delta\alpha$	—	0,4	0,7	dB	
<b>Group delay</b>		$\tau$					
Group delay ripple (p-p) 389,28 ... 416,28 MHz		$\Delta\tau$	—	6	15	ns	
<b>Impedance</b> at 402,78 MHz							
Input: $Z_{IN} = R_{IN} \parallel C_{IN}$			—	220 $\parallel$ 4,7	—	$\Omega \parallel$ pF	
Output: $Z_{OUT} = R_{OUT} \parallel C_{OUT}$			—	1190 $\parallel$ 1,7	—	$\Omega \parallel$ pF	
<b>Temperature coefficient of frequency</b>		$TC_f$	—	-86	—	ppm/K	

**B 609**  
**402,78 MHz**

**Frequency response**

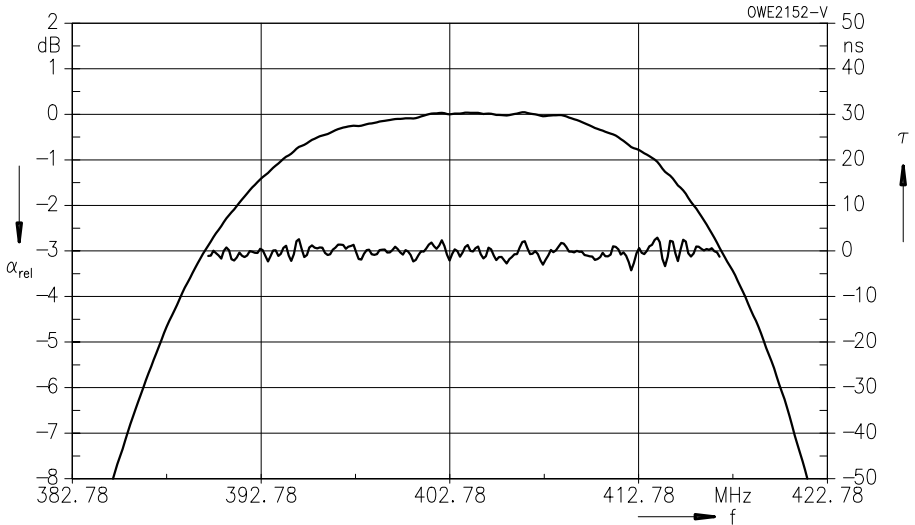
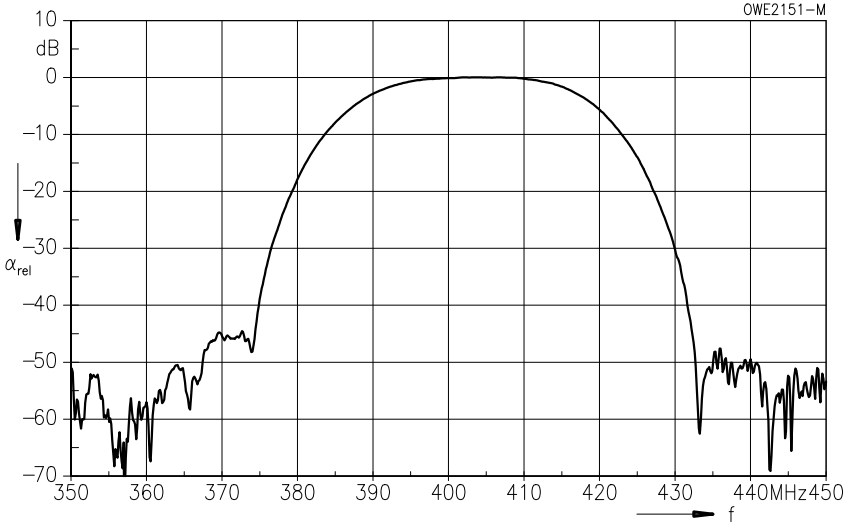

**Characteristics of channel 2**

Ambient temperature  $T_A = 25\text{ °C}$   
 Source impedance  $Z_S = 50\ \Omega$   
 Load impedance  $Z_L = 50\ \Omega$   
 Group delay aperture 0,25 MHz

				min.	typ.	max.	
<b>Insertion attenuation</b>	402,78 MHz	$\alpha$	—	23,4	25,0	dB	
Reference level for the following data							
<b>Pass bandwidth</b> ( $\alpha_{\text{rel}} \leq 3\text{ dB}$ )		$B_{3\text{dB}}$	—	31,00	—	MHz	
<b>Relative attenuation</b>		$\alpha_{\text{rel}}$					
	387,28 MHz		—	3,2	4,0	dB	
	418,28 MHz		—	2,3	4,0	dB	
Lower sidelobe	350,00 ... 372,78 MHz		30,0	41,0	—	dB	
Upper sidelobe	432,78 ... 450,00 MHz		30,0	37,6	—	dB	
<b>Reflected wave signal suppression</b>							
0,07 $\mu\text{s}$ ... 3,0 $\mu\text{s}$ after main pulse			40,0	51,0	—	dB	
<b>Amplitude</b>							
Amplitude ripple (p-p)	396,78 ... 408,78 MHz	$\Delta\alpha$	—	0,4	0,7	dB	
<b>Group delay</b>		$\tau$					
Group delay ripple (p-p)	387,28 ... 418,28 MHz	$\Delta\tau$	—	6	15	ns	
<b>Impedance</b> at 479,50 MHz							
Output: $Z_{\text{OUT}} = R_{\text{OUT}} \parallel C_{\text{OUT}}$			—	1380 $\parallel$ 1,6	—	$\Omega \parallel \text{pF}$	
<b>Temperature coefficient of frequency</b>		$TC_f$	—	- 86	—	ppm/K	

**B 609**  
**402,78 MHz**

**Frequency response**

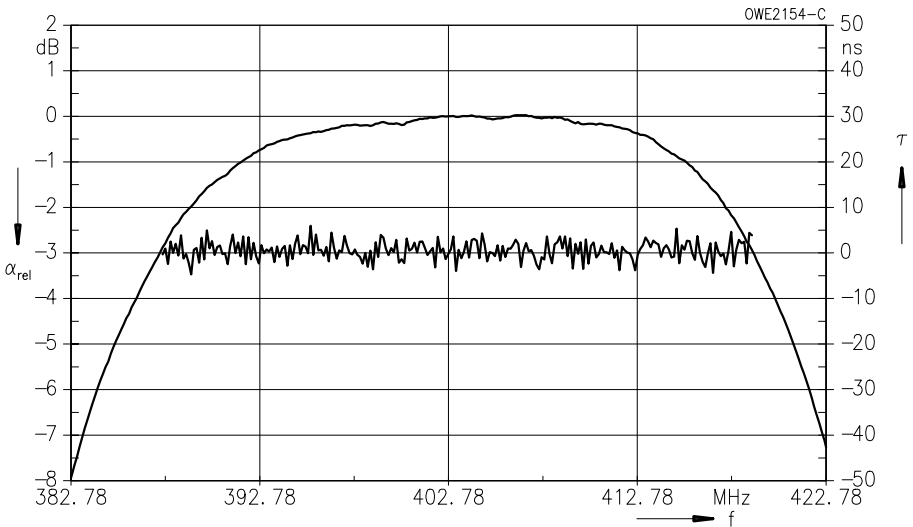
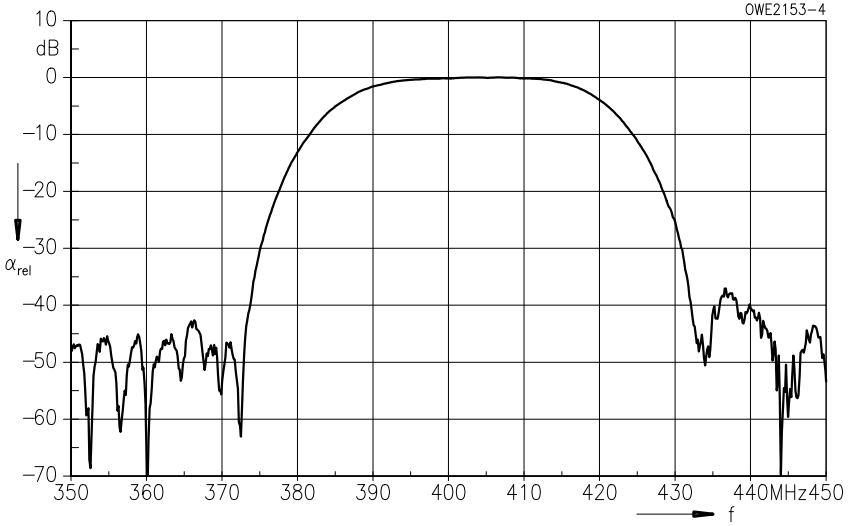

**Features**

- IF filter for DSB receivers
- Constant group delay
- Optimized group delay time

**Terminals**

- Gold-plated NiFeCo alloy

Metal package TO 39

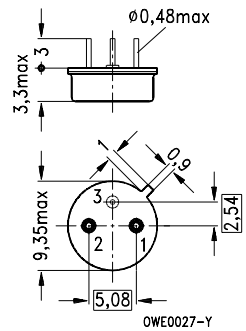

Dimensions in mm, approx. weight 1,0 g

**Pin configuration**

- 1 Input
- 2 Output
- 3 Ground

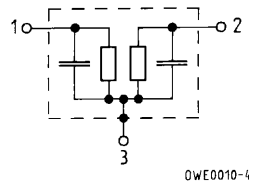

Type	Ordering code	Marking
B 682	B39401-B682-B510	Type, date code

Electrostatic Sensitive Device (ESD)

**Maximum ratings**

Ambient temperature	$T_A$	- 20/+ 80	°C	—
Storage temperature	$T_{stg}$	- 25/+ 85	°C	—
DC voltage	$V_{DC}$	0	V	between any terminals
AC voltage	$V_{pp}$	5	V	between any terminals

# B 682

## 403,18 MHz

### Characteristics

Ambient temperature	$T_A = 25 (35) \text{ }^\circ\text{C}$
Source impedance	$Z_S = 50 \text{ } \Omega$
Load impedance	$Z_L = 50 \text{ } \Omega$
Group delay aperture	0,25 MHz

				min.	typ.	max.	
<b>Insertion attenuation</b>	403,18 (402,78) MHz	$\alpha$	—	22,0	24,0		dB
Reference level for the following data							
<b>Center frequency</b>		$f_c$	402,18	403,18	404,18		MHz
<b>Pass bandwidth</b> ( $\alpha_{rel} \leq 3 \text{ dB}$ )		$B_{3dB}$	30,30	31,30	32,30		MHz
<b>Relative attenuation</b>		$\alpha_{rel}$					
	387,67 (367,28) MHz		—	3,0	4,7		dB
	418,70 (418,28) MHz		—	3,2	4,7		dB
Lower sidelobe	350,35 ... 376,17 MHz (350,00 ... 375,78) MHz		36,0	40,0	—		dB
Upper sidelobe	430,21 ... 450,45 MHz (429,78 ... 450,00) MHz		35,0	38,0	—		dB
<b>Reflected wave signal suppression</b>	0,16 $\mu\text{s}$ ... 3,0 $\mu\text{s}$ after main pulse		40,0	48,5	—		dB
<b>Amplitude</b>							
Amplitude ripple (p-p)	394,18 ... 412,18 MHz	$\Delta\alpha$	—	0,3	0,5		dB
<b>Group delay</b>	403,18 MHz	$\tau$	—	282	—		ns
Group delay ripple (p-p)	388,17 ... 418,20 MHz	$\Delta\tau$	—	11	18		ns
<b>Impedance</b> at 403,18 MHz							
	Input: $Z_{IN} = R_{IN} \parallel C_{IN}$		—	90 $\parallel$ 5,8	—		$\Omega \parallel \text{pF}$
	Output: $Z_{OUT} = R_{OUT} \parallel C_{OUT}$		—	730 $\parallel$ 3,9	—		$\Omega \parallel \text{pF}$
<b>Temperature coefficient of frequency</b>		$TC_f$	—	-86	—		ppm/K

Frequency response

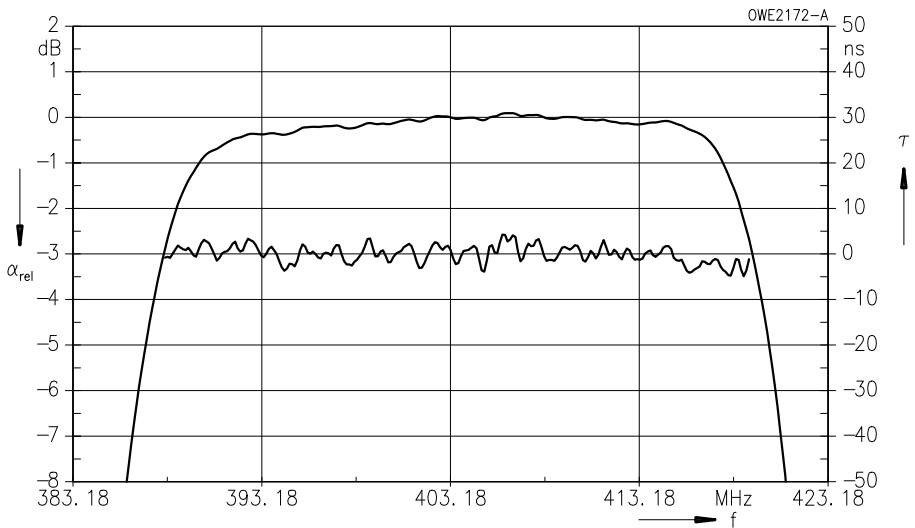
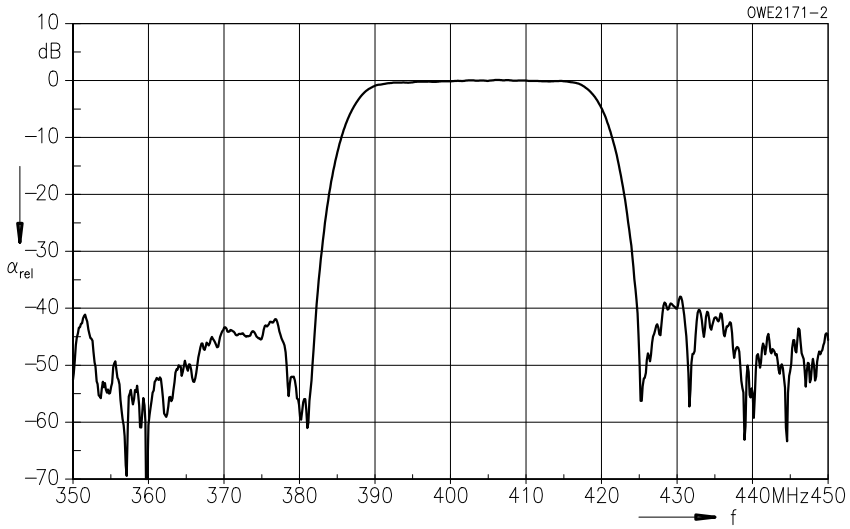

### Features

- Two-channel satellite receiver filter
- IF filter for DSB receivers
- Constant group delay

### Terminals

- Gold-plated NiFeCo alloy

Metal package TO 39

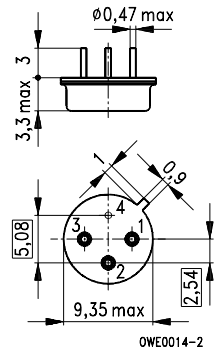

Dimensions in mm, approx. weight 1,0 g

### Pin configuration

- 1 Input
- 2 Output – channel 2
- 3 Output – channel 1
- 4 Ground

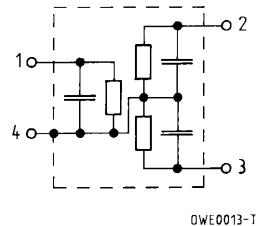

Type	Ordering code	Marking
B 611	B39481-B611-B210	Type, date code

Electrostatic Sensitive Device (ESD)

### Maximum ratings

Ambient temperature	$T_A$	- 20/+ 80	°C	—
Storage temperature	$T_{stg}$	- 25/+ 85	°C	—
DC voltage	$V_{DC}$	0	V	between any terminals
AC voltage	$V_{pp}$	5	V	between any terminals



**Characteristics of channel 1**

Ambient temperature  $T_A = 25\text{ °C}$   
 Source impedance  $Z_S = 50\ \Omega$   
 Load impedance  $Z_L = 50\ \Omega$   
 Group delay aperture 0,25 MHz

				min.	typ.	max.	
<b>Insertion attenuation</b>	479,50 MHz	$\alpha$	—	21,0	22,5	dB	
Reference level for the following data							
<b>Center frequency</b>		$f_c$	478,50	479,50	480,50	MHz	
<b>Pass bandwidth</b> ( $\alpha_{rel} \leq 3\text{ dB}$ )		$B_{3dB}$	—	27,00	—	MHz	
<b>Relative attenuation</b>		$\alpha_{rel}$	—	3,3	4,5	dB	
	466,00 MHz		—	2,5	4,5	dB	
Lower sidelobe	430,00 ... 452,00 MHz		36,0	45,0	—	dB	
Upper sidelobe	507,00 ... 530,00 MHz		34,0	44,0	—	dB	
<b>Reflected wave signal suppression</b>							
0,13 $\mu$ s ... 2,0 $\mu$ s after main pulse			40,0	49,0	—	dB	
<b>Amplitude</b>							
Amplitude ripple (p-p)	471,00 ... 488,00 MHz	$\Delta\alpha$	—	0,3	0,6	dB	
<b>Group delay</b>							
Group delay ripple (p-p)	466,00 ... 493,00 MHz	$\Delta\tau$	—	11	18	ns	
<b>Impedance at 479,50 MHz</b>							
Input: $Z_{IN} = R_{IN} \parallel C_{IN}$			—	170 $\parallel$ 3,6	—	$\Omega \parallel$ pF	
Output: $Z_{OUT} = R_{OUT} \parallel C_{OUT}$			—	180 $\parallel$ 3,8	—	$\Omega \parallel$ pF	
<b>Temperature coefficient of frequency</b>			$TC_f$	—	-86	—	ppm/K

**B 611**  
**479,50 MHz**

**Frequency response**

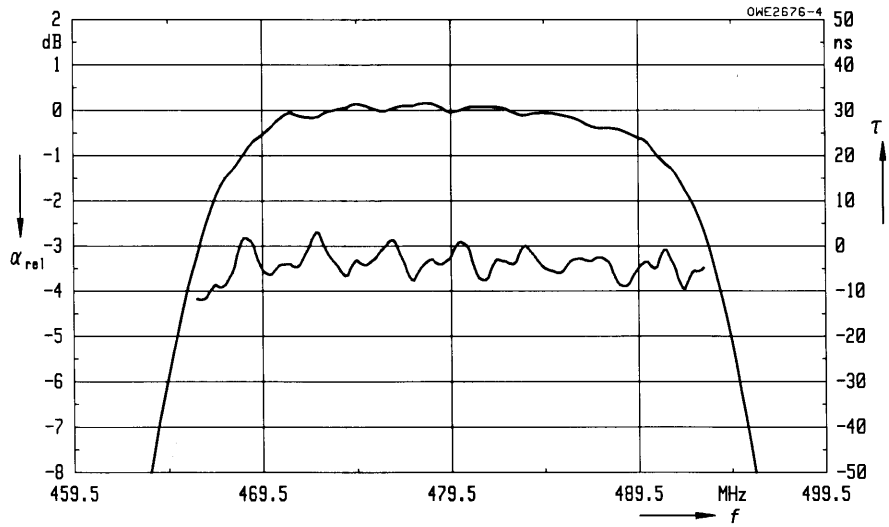
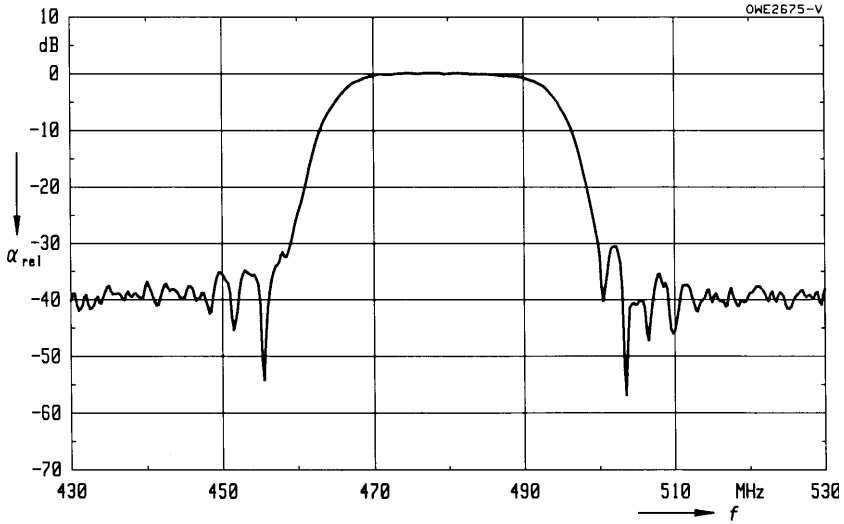

**Characteristics of channel 2**

Ambient temperature  $T_A = 25\text{ °C}$   
 Source impedance  $Z_S = 50\ \Omega$   
 Load impedance  $Z_L = 50\ \Omega$   
 Group delay aperture 0,25 MHz

				min.	typ.	max.	
<b>Insertion attenuation</b>	479,50 MHz	$\alpha$	—	20,4	22,1	dB	
Reference level for the following data							
<b>Center frequency</b>		$f_c$	478,50	479,50	480,50	MHz	
<b>Pass bandwidth</b> ( $\alpha_{rel} \leq 3\text{ dB}$ )		$B_{3dB}$	—	18,00	—	MHz	
<b>Relative attenuation</b>		$\alpha_{rel}$	—	3,5	4,5	dB	
	470,50 MHz		—	2,3	4,5	dB	
Lower sidelobe	430,00 ... 457,50 MHz		36,0	44,0	—	dB	
Upper sidelobe	500,50 ... 530,00 MHz		34,0	42,0	—	dB	
<b>Reflected wave signal suppression</b>			40,0	44,0	—	dB	
0,13 $\mu\text{s}$ ... 2,0 $\mu\text{s}$ after main pulse							
<b>Amplitude</b>			—	0,3	0,6	dB	
Amplitude ripple (p-p)	476,00 ... 483,00 MHz	$\Delta\alpha$	—	0,3	0,6	dB	
<b>Group delay</b>		$\tau$	—	11	18	ns	
Group delay ripple (p-p)	470,50 ... 488,50 MHz	$\Delta\tau$	—	11	18	ns	
<b>Impedance at 479,50 MHz</b>			—	130    3,3	—	$\Omega$    pF	
Output: $Z_{OUT} = R_{OUT} \parallel C_{OUT}$							
<b>Temperature coefficient of frequency</b>		$TC_f$	—	- 86	—	ppm/K	

Frequency response

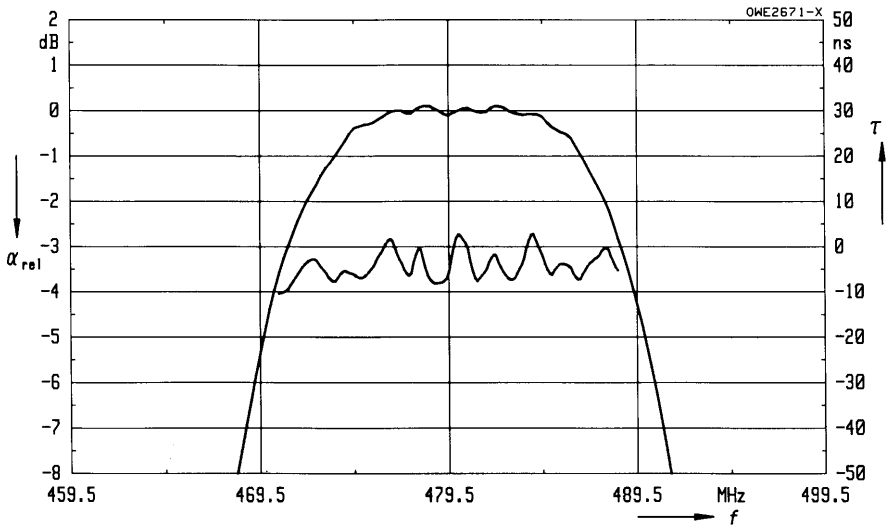
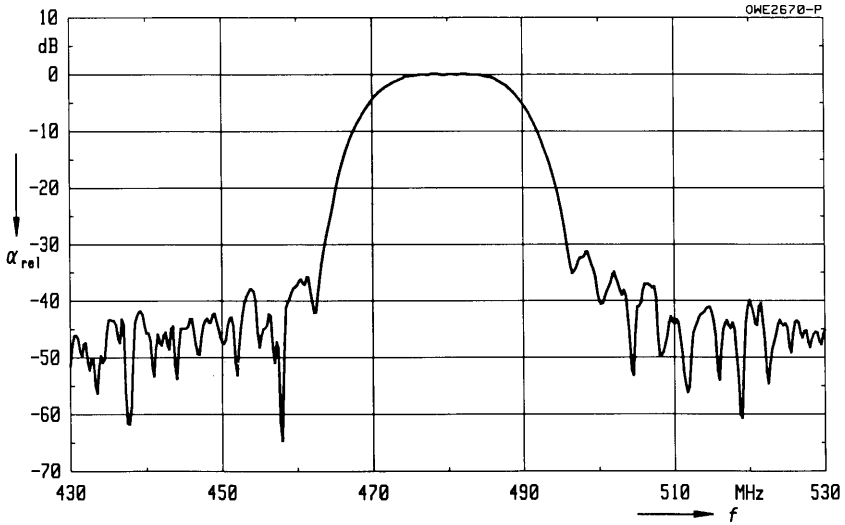

**Features**

- Two-channel satellite receiver filter
- IF filter for DSB receivers
- Constant group delay
- Improved ESD capability by integrated shunt resistors

**Terminals**

- Gold-plated NiFeCo alloy

Metal package TO 39

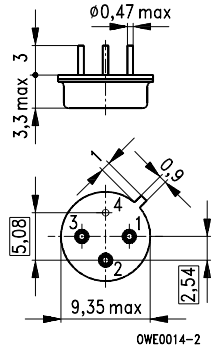

Dimensions in mm, approx. weight 1,0 g

**Pin configuration**

- 1 Input
- 2 Output – channel 2
- 3 Output – channel 1
- 4 Ground

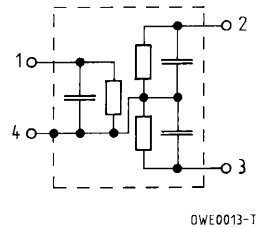

Type	Ordering code	Marking
B 635	B39481-B635-B210	Type, date code

Electrostatic Sensitive Device (ESD)

**Maximum ratings**

Ambient temperature	$T_A$	- 20/+ 80	°C	—
Storage temperature	$T_{stg}$	- 25/+ 85	°C	—
DC voltage	$V_{DC}$	0	V	between any terminals
AC voltage	$V_{pp}$	5	V	between any terminals

# B 635

## 480,00 MHz

### Characteristics of channel 1

Ambient temperature	$T_A = 25\text{ °C}$
Source impedance	$Z_S = 50\ \Omega$
Load impedance	$Z_L = 50\ \Omega$
Group delay aperture	0,25 MHz

			min.	typ.	max.	
<b>Insertion attenuation</b>	480,00 MHz	$\alpha$	—	23,2	25,0	dB
Reference level for the following data						
<b>Center frequency</b>		$f_c$	479,00	480,00	481,00	MHz
<b>Pass bandwidth</b> ( $\alpha_{rel} \leq 3\text{ dB}$ )		$B_{3dB}$	—	33,50	—	MHz
<b>Relative attenuation</b>		$\alpha_{rel}$				
	463,50 MHz		—	2,2	—	dB
	496,50 MHz		—	3,0	—	dB
Lower sidelobe	430,00 ... 455,00 MHz		36,0	42,5	—	dB
Upper sidelobe	505,00 ... 530,00 MHz		36,0	43,5	—	dB
<b>Reflected wave signal suppression</b>						
0,135 $\mu\text{s}$ ... 2,0 $\mu\text{s}$ after main pulse			40,0	45,0	—	dB
<b>Amplitude</b>						
Amplitude ripple (p-p) 470,50 ... 489,50 MHz $\Delta\alpha$			—	0,2	0,6	dB
<b>Group delay</b>	480,00 MHz	$\tau$	—	300	—	ns
Group delay ripple (p-p) 464,00 ... 496,00 MHz $\Delta\tau$			—	9	18	ns
<b>Impedance at 480,00 MHz</b>						
Input: $Z_{IN} = R_{IN} \parallel C_{IN}$			—	60 $\parallel$ 5,3	—	$\Omega \parallel \text{pF}$
Output: $Z_{OUT} = R_{OUT} \parallel C_{OUT}$			—	230 $\parallel$ 3,8	—	$\Omega \parallel \text{pF}$
<b>DC resistance</b>						
Input: $R_{IN}$			—	250	—	$\Omega$
Output: $R_{OUT}$			—	500	—	$\Omega$
<b>Temperature coefficient of frequency</b>		$TC_f$	—	- 86	—	ppm/K

**Frequency response**

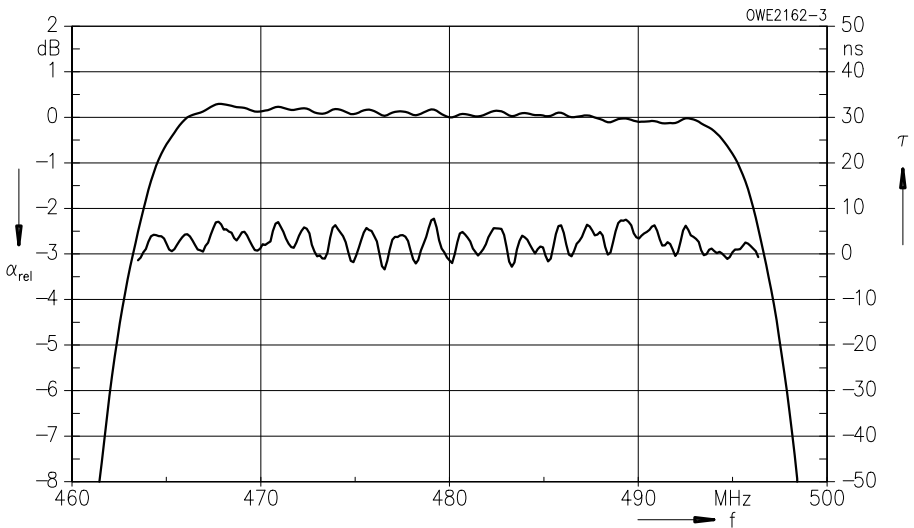
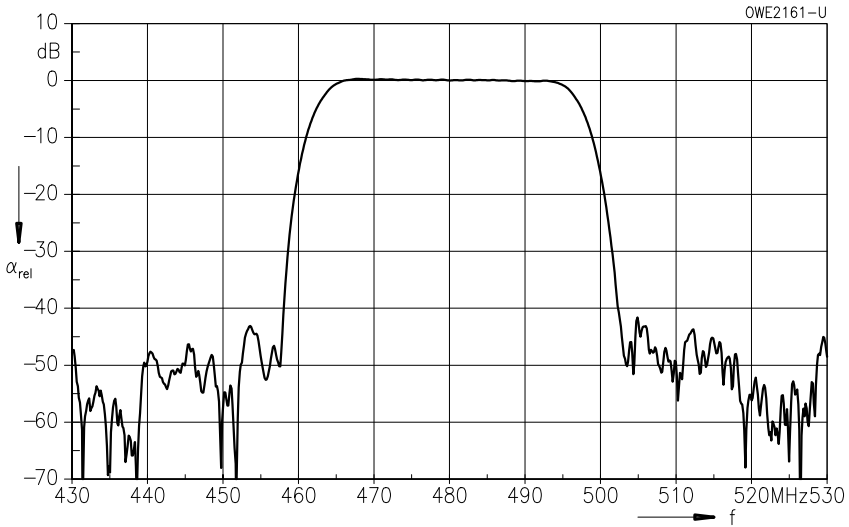

## B 635

### 480,00 MHz

#### Characteristics of channel 2

Ambient temperature	$T_A = 25\text{ °C}$
Source impedance	$Z_S = 50\ \Omega$
Load impedance	$Z_L = 50\ \Omega$
Group delay aperture	0,25 MHz

			min.	typ.	max.	
<b>Insertion attenuation</b>	480,00 MHz	$\alpha$	—	22,2	25,0	dB
Reference level for the following data						
<b>Center frequency</b>		$f_c$	479,00	480,00	481,00	MHz
<b>Pass bandwidth</b> ( $\alpha_{rel} \leq 3\text{ dB}$ )		$B_{3dB}$	—	36,10	—	MHz
<b>Relative attenuation</b>		$\alpha_{rel}$				
	462,00 MHz		—	2,7	—	dB
	498,00 MHz		—	3,1	—	dB
Lower sidelobe	430,00 ... 453,50 MHz		36,0	47,0	—	dB
Upper sidelobe	506,50 ... 530,00 MHz		36,0	45,0	—	dB
<b>Reflected wave signal suppression</b>						
0,13 $\mu$ s ... 2,0 $\mu$ s after main pulse			40,0	45,0	—	dB
<b>Amplitude</b>						
Amplitude ripple (p-p)	469,00 ... 491,00 MHz	$\Delta\alpha$	—	0,4	0,7	dB
<b>Group delay</b>	480,00 MHz	$\tau$	—	300	—	ns
Group delay ripple (p-p)	462,50 ... 497,50 MHz	$\Delta\tau$	—	10	18	ns
<b>Impedance at 480,00 MHz</b>						
Input: $Z_{IN} = R_{IN} \parallel C_{IN}$			—	60 $\parallel$ 5,3	—	$\Omega \parallel$ pF
Output: $Z_{OUT} = R_{OUT} \parallel C_{OUT}$			—	220 $\parallel$ 4,3	—	$\Omega \parallel$ pF
<b>DC Resistance</b>						
Input: $R_{IN}$			—	250	—	$\Omega$
Output: $R_{OUT}$			—	500	—	$\Omega$
<b>Temperature coefficient of frequency</b>		$TC_f$	—	- 86	—	ppm/K



**Frequency response**

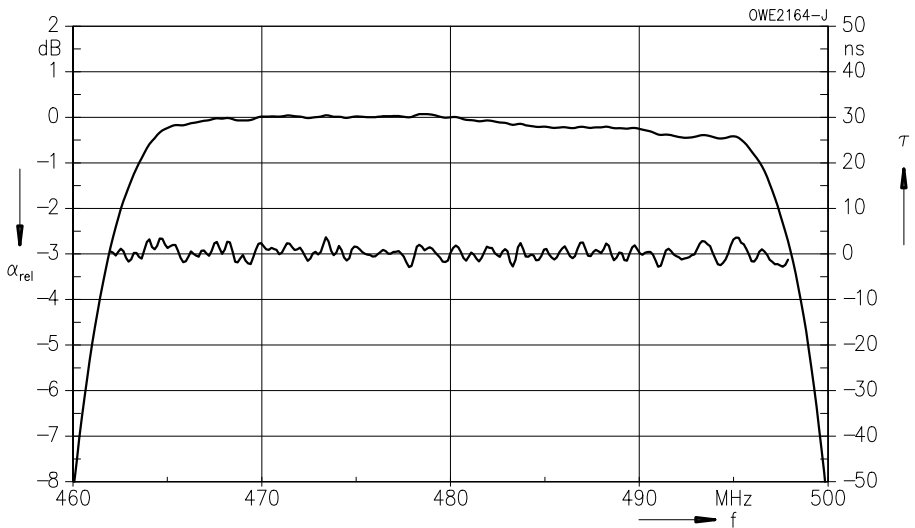
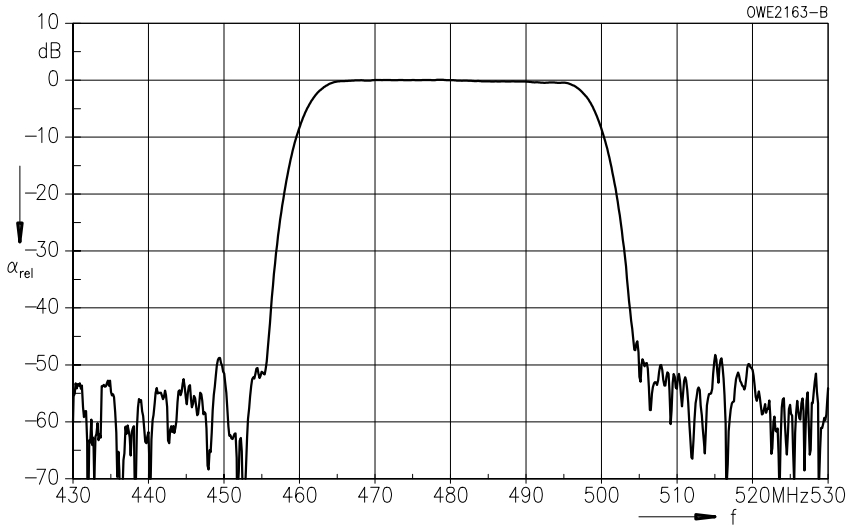

**Features**

- IF filter for DSB receivers
- Constant group delay
- Optimized group delay time
- Improved ESD capability by integrated shunt resistors

**Terminals**

- Gold-plated NiFeCo alloy

Metal package TO 39

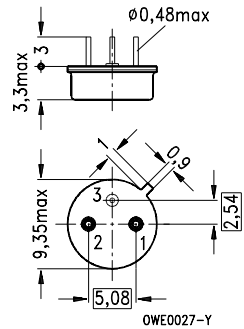

Dimensions in mm, approx. weight 1,0 g

**Pin configuration**

- 1 Input
- 2 Output
- 3 Ground

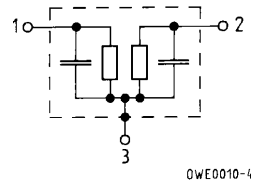

Type	Ordering code	Marking
B 692	B39481-B692-B510	Type, date code

Electrostatic Sensitive Device (ESD)

**Maximum ratings**

Ambient temperature	$T_A$	- 20/+ 80	°C	—
Storage temperature	$T_{stg}$	- 25/+ 85	°C	—
DC voltage	$V_{DC}$	0	V	between any terminals
AC voltage	$V_{pp}$	5	V	between any terminals

**Characteristics**

Ambient temperature	$T_A = 25\text{ °C}$
Source impedance	$Z_S = 50\ \Omega$
Load impedance	$Z_L = 50\ \Omega$
Group delay aperture	0,25 MHz

			min.	typ.	max.	
<b>Insertion attenuation</b>	480,00 MHz	$\alpha$	—	20,0	21,5	dB
Reference level for the following data						
<b>Center frequency</b>		$f_c$	479,00	480,00	481,00	MHz
<b>Pass bandwidth</b> ( $\alpha_{rel} \leq 3\text{ dB}$ )		$B_{3dB}$	25,60	26,60	27,60	MHz
<b>Relative attenuation</b>		$\alpha_{rel}$				
	466,50 MHz		—	3,0	4,6	dB
	493,50 MHz		—	3,2	4,6	dB
Lower sidelobe	430,00 ... 455,50 MHz		40,0	46,3	—	dB
Upper sidelobe	504,50 ... 530,00 MHz		38,0	42,0	—	dB
<b>Reflected wave signal suppression</b>						
0,11 $\mu$ s ... 2,0 $\mu$ s after main pulse			40,0	47,0	—	dB
<b>Amplitude</b>						
Amplitude ripple (p-p)	473,50 ... 486,50 MHz	$\Delta\alpha$	—	0,3	0,5	dB
<b>Group delay</b>	480,00 MHz	$\tau$	—	250	—	ns
Group delay ripple (p-p)	467,00 ... 493,00 MHz	$\Delta\tau$	—	9	15	ns
<b>Impedance at 480,00 MHz</b>						
Input: $Z_{IN} = R_{IN} \parallel C_{IN}$			—	60 $\parallel$ 4,8	—	$\Omega \parallel$ pF
Output: $Z_{OUT} = R_{OUT} \parallel C_{OUT}$			—	260 $\parallel$ 3,1	—	$\Omega \parallel$ pF
<b>DC resistance</b>						
Input: $R_{IN}$			—	500	—	$\Omega$
Output: $R_{OUT}$			—	500	—	$\Omega$
<b>Temperature coefficient of frequency</b>		$TC_f$	—	- 86	—	ppm/K

**Frequency response**

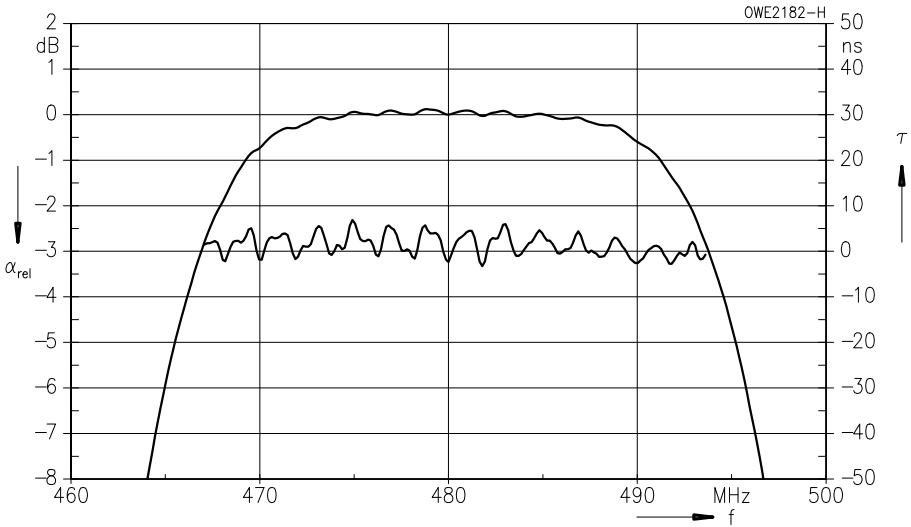
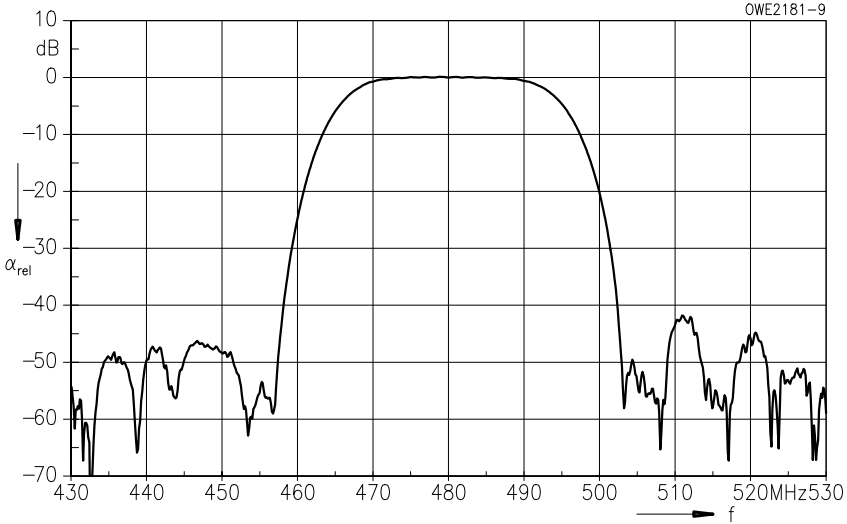

**Features**

- IF filter for DSB receivers
- Constant group delay
- Optimized group delay time
- Improved ESD capability by integrated shunt resistors

**Terminals**

- Gold-plated NiFeCo alloy

Metal package TO 39

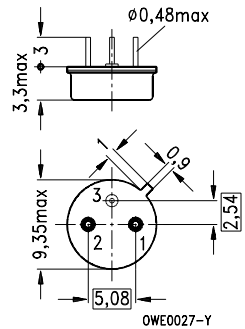

Dimensions in mm, approx. weight 1,0 g

**Pin configuration**

- 1 Input
- 2 Output
- 3 Ground

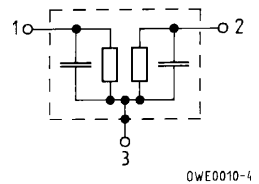

Type	Ordering code	Marking
B 694	B39481-B694-B510	Type, date code

Electrostatic Sensitive Device (ESD)

**Maximum ratings**

Ambient temperature	$T_A$	- 20/+ 80	°C	—
Storage temperature	$T_{stg}$	- 25/+ 85	°C	—
DC voltage	$V_{DC}$	0	V	between any terminals
AC voltage	$V_{pp}$	5	V	between any terminals

# B 694

## 480,00 MHz

### Characteristics

Ambient temperature	$T_A = 25\text{ °C}$
Source impedance	$Z_S = 50\ \Omega$
Load impedance	$Z_L = 50\ \Omega$
Group delay aperture	0,25 MHz

				min.	typ.	max.	
<b>Insertion attenuation</b>	480,00 MHz	$\alpha$	—	19,5	21,0	dB	
Reference level for the following data							
<b>Center frequency</b>		$f_c$	479,00	480,00	481,00	MHz	
<b>Pass bandwidth</b> ( $\alpha_{rel} \leq 3\text{ dB}$ )		$B_{3dB}$	16,60	17,60	18,60	MHz	
<b>Relative attenuation</b>		$\alpha_{rel}$					
	471,00 MHz		—	3,4	5,4	dB	
	489,00 MHz		—	3,0	5,4	dB	
Lower sidelobe	430,00 ... 461,00 MHz		38,0	50,0	—	dB	
Upper sidelobe	499,00 ... 530,00 MHz		38,0	45,0	—	dB	
<b>Reflected wave signal suppression</b>							
0,13 $\mu$ s ... 2,0 $\mu$ s after main pulse			40,0	46,0	—	dB	
<b>Amplitude</b>							
Amplitude ripple (p-p) 476,00 ... 484,00 MHz $\Delta\alpha$			—	0,3	0,6	dB	
<b>Group delay</b>	480,00 MHz	$\tau$	—	281	—	ns	
Group delay ripple (p-p) 471,50 ... 488,50 MHz $\Delta\tau$			—	12	18	ns	
<b>Impedance at 480,00 MHz</b>							
Input: $Z_{IN} = R_{IN} \parallel C_{IN}$			—	70 $\parallel$ 3,7	—	$\Omega \parallel$ pF	
Output: $Z_{OUT} = R_{OUT} \parallel C_{OUT}$			—	280 $\parallel$ 2,5	—	$\Omega \parallel$ pF	
<b>DC resistance</b>							
Input: $R_{IN}$			—	500	—	$\Omega$	
Output: $R_{OUT}$			—	500	—	$\Omega$	
<b>Temperature coefficient of frequency</b>		$TC_f$	—	- 86	—	ppm/K	

**Frequency response**

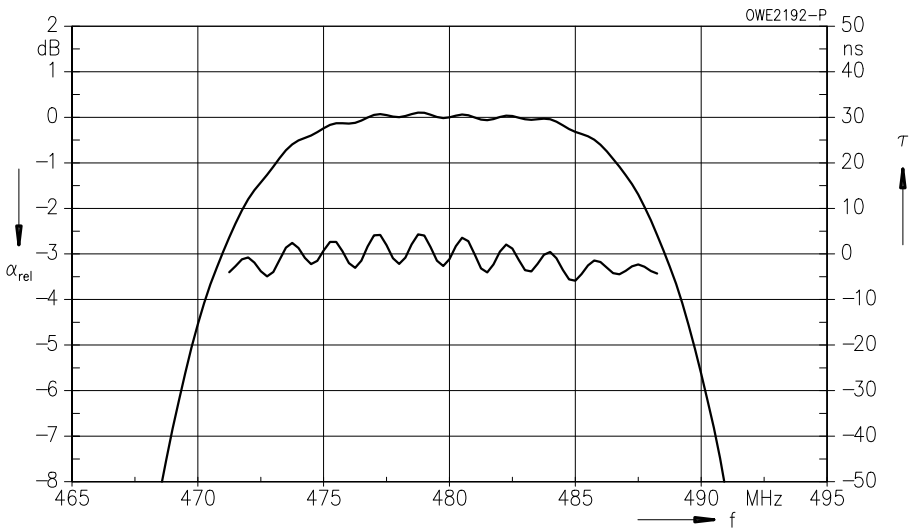
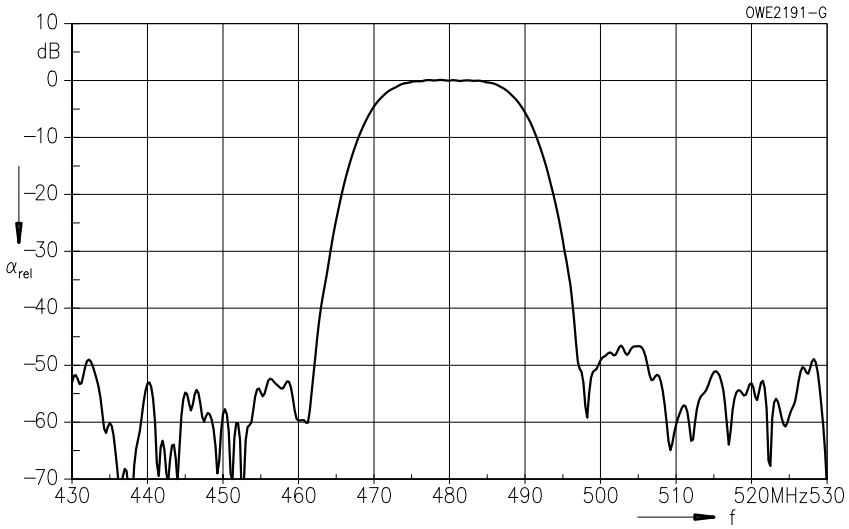



Siemens Matsushita Components

Ceramic chip capacitors from stock

# Small in size, big in performance

Our selection of capacitors ranges from standard sizes down to a miniature highlight in 0402 style. Measuring only 1 x 0.5 x 0.5 mm, it's an ideal solution for applications where space is tight, like in handies and cardiac pacemakers. At the same time all our chips can boast excellent soldering characteristics, with special terminal variants for conductive adhesion. And we also thought about the right packing for automatic placement. You get all sizes down to 1206 in bulk case for example, plus voltage ratings from 16 to 500 V. By the way, our leaded models have CECC approval of course, in fact they were certified more than ten years ago.

More in the new short form catalog!



SCS - dependable, fast and competent





## Vestigial Sideband Filters

### Survey

Picture carrier MHz	Vestigial sideband MHz	Sound	Standard <sup>1)</sup>	Package	Type	Page <sup>2)</sup>
32,70	0,7	no	L	DIP 24-06	B 540	#
38,00	0,75	yes	D/K	DIP 24-06	B 542	#
	0,75	yes	D/K	SIP 6 M	B 587	#
38,90	0,75	yes	B/G	DIP 24-03	B 522	#
	0,75	no	B/G	DIP 24-03	B 523	<a href="#">274</a>
	0,75	yes	B/G	DIP 16	B 530	<a href="#">277</a>
	0,75	no	B/G	DIP 16	B 531	#
	0,75	yes	B/G	DIP 24-06	B 534	#
	0,75	no	B/G	DIP 24-06	B 537	<a href="#">280</a>
	1,25	no	I	DIP 24-06	B 541	#
	0,75	no	D/K	DIP 24-06	B 543	#
	1,00	NICAM	I	DIP 24-06	B 576	#
	0,75	yes	B/G	SIP 6 M	B 585	<a href="#">283</a>
	1,25	yes	I	SIP 6 M	B 586	#
	0,75	yes	B/G	SIP 6 M	B 588	#
	0,75	yes	B/G	SIP 5 K	G 4960 M	<a href="#">286</a>
	0,75	yes	D/K	SIP 5 K	K 4960 M	#
45,75	0,75	no	M/N	DIP 24-06	B 545	<a href="#">289</a>
	0,75	yes	M/N	SIP 5 K	M 4950 M	#

1) For explanation of standards see individual data sheets or index on page [349](#)

2) Filters marked by the sign # are only listed in the survey. Detailed information on these types upon request.

### Standard

- B/G  
Germany, Europe

### Features

- Vestigial sideband filter with sound suppression
- Constant group delay
- Hermetically sealed metal package

### Terminals

- Gold-plated NiFeCo alloy

Metal package DIP 24-03

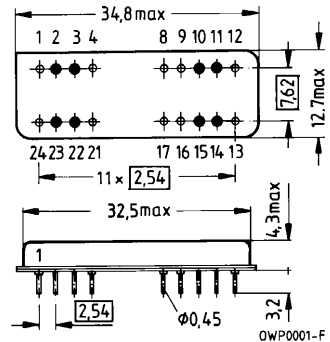

Dimensions in mm, approx. weight 6,4 g

### Pin configuration

- |                    |                 |
|--------------------|-----------------|
| 3                  | Input           |
| 2                  | Input – ground  |
| 15                 | Output          |
| 14                 | Output – ground |
| 1, 4, 8, 9, 12,    |                 |
| 13, 16, 17, 21, 24 | Case – ground   |
| 10, 11, 22, 23     | Not connected   |

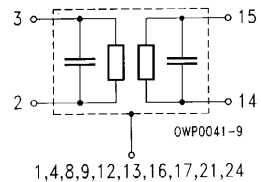

Type	Ordering code	Marking
B 523	B39380-B523-G410	Type, date code, pin 1

Electrostatic Sensitive Device (ESD)

### Maximum ratings

Ambient temperature	$T_A$	- 25/+ 85	°C	—
Storage temperature	$T_{stg}$	- 40/+ 85	°C	—
DC voltage	$V_{DC}$	0	V	—
Source power	$P_s$	15	dBm	source impedance 50 $\Omega$

**Characteristics**

Ambient temperature	$T_A = 25\text{ °C}$
Source impedance	$Z_S = 50\ \Omega$
Load impedance	$Z_L = 50\ \Omega$
Group delay aperture	120 kHz

		min.	typ.	max.	
<b>Nominal frequency</b>	$f_N$	—	38,90	—	MHz
<b>Insertion attenuation at <math>f_N</math></b>	$\alpha_N$	28,0	30,0	32,0	dB
<b>Relative attenuation (relative to <math>\alpha_N</math>)</b>	$\alpha_{rel}$				
33,40 MHz		38,0	40,0	—	dB
34,00 MHz		-0,5	0,8	1,5	dB
34,10 MHz		-0,5	0,2	0,6	dB
39,65 MHz		1,0	1,5	2,0	dB
25,00 ... 32,00 MHz		45,0	53,0	—	dB
32,00 ... 32,65 MHz		40,0	48,0	—	dB
32,65 ... 33,30 MHz		38,0	41,0	—	dB
40,15 ... 41,20 MHz		38,0	41,0	—	dB
41,20 ... 45,00 MHz		44,0	48,0	—	dB
<b>Amplitude ripple (p-p)</b>	$\Delta\alpha$				
34,30 ... 39,00 MHz		—	0,3	0,5	dB
34,20 ... 39,40 MHz		—	0,6	1,0	dB
<b>Reflected wave signal suppression</b> 2,5 $\mu$ s ... 12,0 $\mu$ s after main pulse		50,0	55,0	—	dB
<b>Group delay at <math>f_N</math></b>	$\tau_N$	—	3,6	—	$\mu$ s
<b>Group delay ripple (p-p)</b> 33,80 ... 39,60 MHz	$\Delta\tau$	—	40	50	ns
<b>Temperature coefficient of frequency</b>	$TC_f$	—	-87	—	ppm/K

**Frequency response**

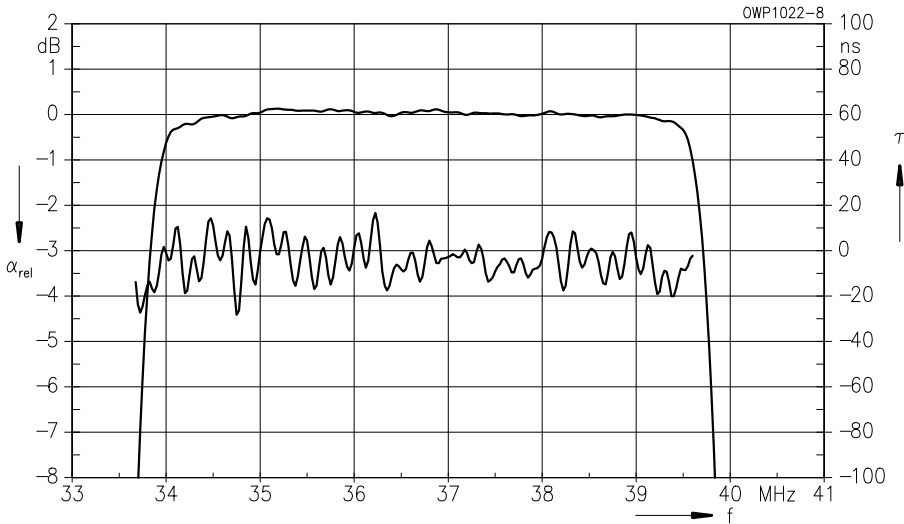
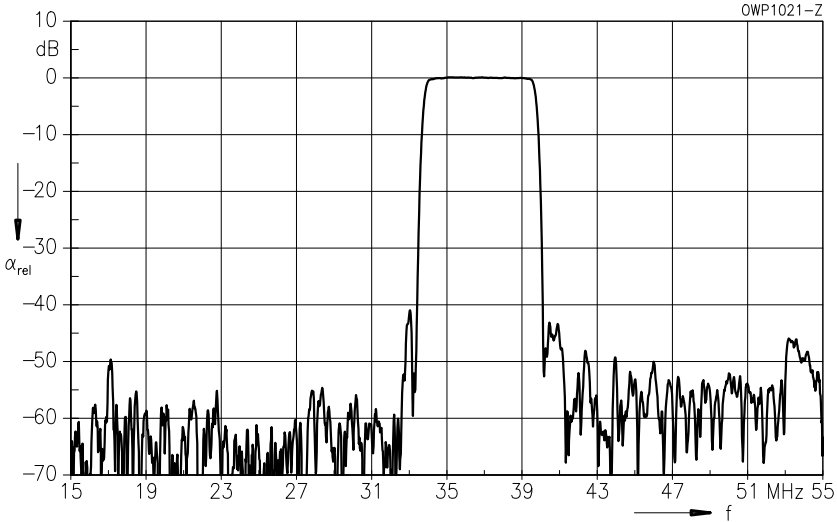

### Standard

- B/G  
Germany, Europe

### Features

- Vestigial sideband filter with sound
- Constant group delay
- Hermetically sealed metal package

### Terminals

- Gold-plated NiFeCo alloy

Metal package DIP 16

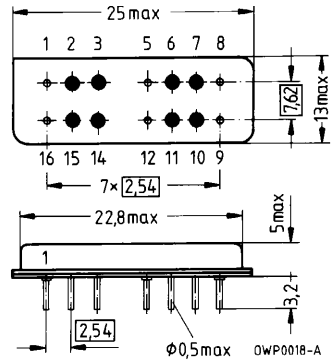

Dimensions in mm, approx. weight 4,2 g

### Pin configuration

- |                    |                 |
|--------------------|-----------------|
| 3                  | Input           |
| 2                  | Input – ground  |
| 11                 | Output          |
| 10                 | Output – ground |
| 1, 5, 8, 9, 12, 16 | Case – ground   |
| 6, 7, 14, 15       | Not connected   |

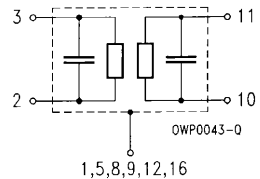

Type	Ordering code	Marking
B 530	B39390-B530-E110	Type, date code, pin 1

Electrostatic Sensitive Device (ESD)

### Maximum ratings

Ambient temperature	$T_A$	- 25/+ 85	°C	—
Storage temperature	$T_{stg}$	- 40/+ 85	°C	—
DC voltage	$V_{DC}$	0	V	—
Source power	$P_s$	15	dBm	source impedance 50 $\Omega$

## B 530

### 38,90 MHz

#### Characteristics

Ambient temperature	$T_A = 50\text{ °C}$
Source impedance	$Z_S = 50\ \Omega$
Load impedance	$Z_L = 50\ \Omega$
Group delay aperture	80 kHz

		min.	typ.	max.	
<b>Nominal frequency</b>	$f_N$	—	38,90	—	MHz
<b>Insertion attenuation at <math>f_N</math></b>	$\alpha_N$	29,0	30,0	31,0	dB
<b>Relative attenuation (relative to <math>\alpha_N</math>)</b>	$\alpha_{rel}$				
31,90 MHz		38,0	43,0	—	dB
33,40 MHz		- 0,1	0,1	0,4	dB
39,65 MHz		0,5	1,3	2,5	dB
40,15 MHz		15,0	20,0	—	dB
40,40 MHz		32,0	36,0	—	dB
20,00 ... 31,00 MHz		45,0	50,0	—	dB
31,00 ... 31,90 MHz		38,0	45,0	—	dB
40,40 ... 41,90 MHz		32,0	36,0	—	dB
41,90 ... 50,00 MHz		40,0	44,0	—	dB
<b>Amplitude ripple (p-p)</b>	$\Delta\alpha$				
34,30 ... 39,00 MHz		—	0,2	0,4	dB
<b>Reflected wave signal suppression</b>					
2,7 $\mu\text{s}$ ... 12,0 $\mu\text{s}$ after main pulse		50,0	60,0	—	dB
<b>Group delay at <math>f_N</math></b>	$\tau_N$	—	2,2	—	$\mu\text{s}$
<b>Group delay ripple (p-p)</b>	$\Delta\tau$				
34,30 ... 39,60 MHz		—	30	50	ns
<b>Temperature coefficient of frequency</b>	$TC_f$	—	- 87	—	ppm/K

**Frequency response**

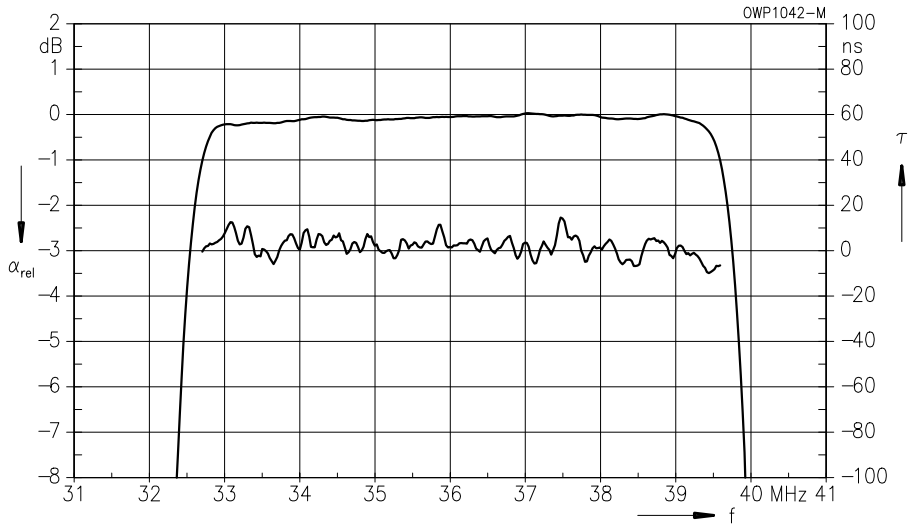
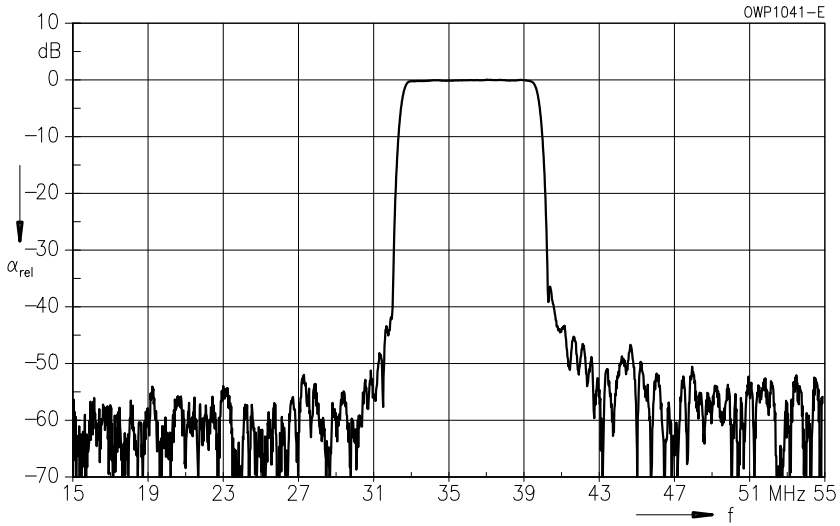

### Standard

- B/G  
Europe, Germany

### Features

- Vestigial sideband filter with sound suppression
- Constant group delay
- Hermetically sealed metal package

### Terminals

- Gold-plated NiFeCo alloy

Metal package DIP 24-06

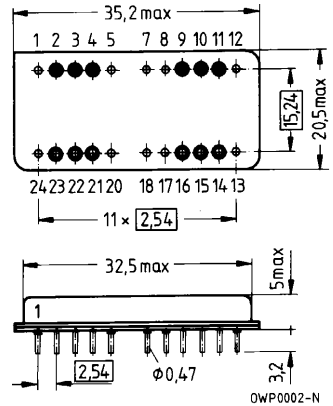

Dimensions in mm, approx. weight 10,4 g

### Pin configuration

- |                    |                 |
|--------------------|-----------------|
| 3                  | Input           |
| 2                  | Input – ground  |
| 15                 | Output          |
| 14                 | Output – ground |
| 1, 5, 7, 8, 12,    |                 |
| 13, 17, 18, 20, 24 | Case – ground   |
| 4, 9, 10, 11,      |                 |
| 16, 21, 22, 23     | Not connected   |

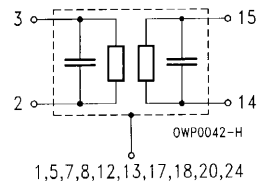

Type	Ordering code	Marking
B 537	B39390-B537-G310	Type, date code, pin 1

Electrostatic Sensitive Device (ESD)

### Maximum ratings

Ambient temperature	$T_A$	- 25/+ 85	°C	—
Storage temperature	$T_{stg}$	- 40/+ 85	°C	—
DC voltage	$V_{DC}$	0	V	—
Source power	$P_s$	15	dBm	source impedance 50 $\Omega$



**Characteristics**

Ambient temperature	$T_A = 60\text{ °C}$
Source impedance	$Z_S = 50\ \Omega$
Load impedance	$Z_L = 50\ \Omega$
Group delay aperture	80 kHz

		min.	typ.	max.	
<b>Nominal frequency</b>	$f_N$	—	38,90	—	MHz
<b>Insertion attenuation at <math>f_N</math></b>	$\alpha_N$	29,0	30,0	31,0	dB
<b>Relative attenuation (relative to <math>\alpha_N</math>)</b>	$\alpha_{rel}$				
33,80 MHz		—	2,1	5,0	dB
33,90 MHz		—	0,5	2,0	dB
39,65 MHz		—	0,8	2,0	dB
15,00 ... 31,90 MHz		48,0	52,0	—	dB
31,90 ... 33,40 MHz		45,0	48,0	—	dB
40,05 ... 40,15 MHz		25,0	45,0	—	dB
40,15 ... 40,65 MHz		45,0	51,0	—	dB
40,65 ... 55,00 MHz		48,0	53,0	—	dB
<b>Amplitude ripple (p-p)</b>	$\Delta\alpha$				
34,15 ... 39,50 MHz		—	0,2	0,4	dB
<b>Reflected wave signal suppression</b>					
3,5 $\mu$ s ... 13,0 $\mu$ s after main pulse		50,0	63,0	—	dB
<b>Group delay at <math>f_N</math></b>	$\tau_N$	—	4,4	—	$\mu$ s
<b>Group delay ripple (p-p)</b>	$\Delta\tau$				
33,90 ... 39,65 MHz		—	40	50	ns
<b>Temperature coefficient of frequency</b>	$TC_f$	—	- 87	—	ppm/K

**Frequency response**

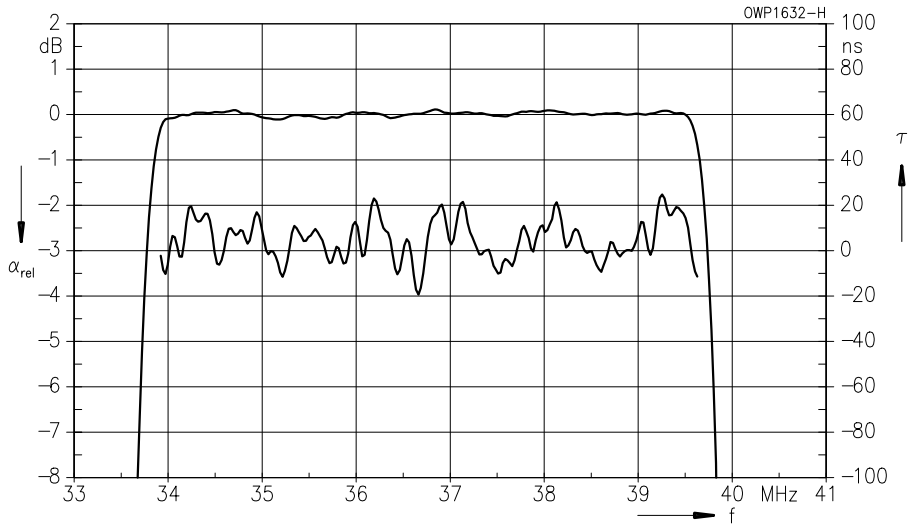
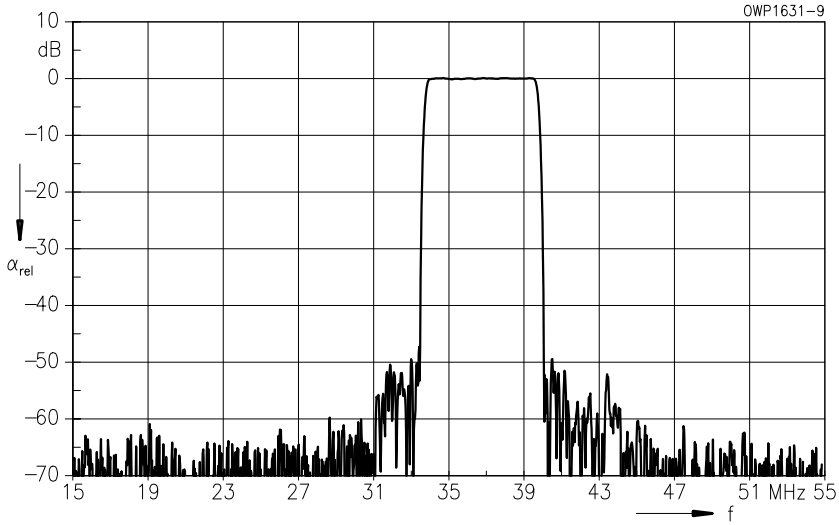

### Standard

- B/G-CCIR  
Germany, Europe partly

Metal package **SIP 6 M**

### Features

- IF filter for antenna converters
- Full transmission of vestigial sideband and sound carrier
- Constant group delay
- Hermetically sealed metal package

### Terminals

- Tinned NiFeCo alloy

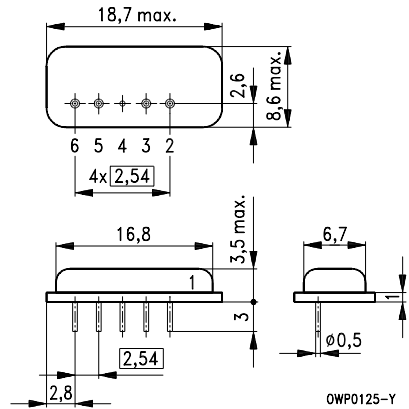

Dimensions in mm, approx. weight 3,0 g

### Pin configuration

- 2 Input
- 3 Input – ground
- 6 Output
- 5 Output – ground
- 4 Case – ground

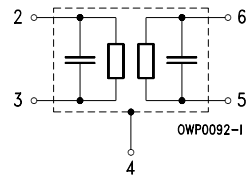

Type	Ordering code	Marking
B 585	B39390-B585-X110	Type, date code, pin 1

Electrostatic Sensitive Device (ESD)

### Maximum ratings

Ambient temperature	$T_A$	- 25/+ 85	°C	—
Storage temperature	$T_{stg}$	- 40/+ 85	°C	—
DC voltage	$V_{DC}$	0	V	—
Source power	$P_s$	15	dBm	source impedance 50 $\Omega$

**B 585**  
**38,90 MHz**

**Characteristics**

Ambient temperature	$T_A = 25\text{ °C}$
Source impedance	$Z_S = 50\ \Omega$
Load impedance	$Z_L = 50\ \Omega$
Group delay aperture	80 kHz

		min.	typ.	max.	
<b>Nominal frequency</b>	$f_N$	—	38,90	—	MHz
<b>Insertion attenuation at <math>f_N</math></b>	$\alpha_N$	33,4	34,9	36,4	dB
<b>Relative attenuation (relative to <math>\alpha_N</math>)</b>	$\alpha_{rel}$				
	39,65 MHz	2,3	3,3	4,3	dB
Sound carrier	33,40 MHz	- 0,8	0,2	1,2	dB
2nd sound carrier	33,15 MHz	- 0,9	0,1	1,1	dB
Adjacent picture carrier	31,90 MHz	34,0	43,0	—	dB
	40,15 MHz	22,0	25,0	—	dB
Adjacent sound carrier	40,40 MHz	34,0	44,0	—	dB
	44,40 MHz	38,0	49,0	—	dB
Lower sidelobe	25,00 ... 31,90 MHz	32,0	38,0	—	dB
Upper sidelobe	40,40 ... 45,00 MHz	30,0	37,0	—	dB
<b>Reflected wave signal suppression</b>					
1,5 $\mu$ s ... 6,0 $\mu$ s after main pulse		42,0	52,0	—	dB
<b>Feedthrough signal suppression</b>					
1,6 $\mu$ s ... 1,5 $\mu$ s before main pulse		50,0	56,0	—	dB
<b>Group delay ripple (p-p)</b>	$\Delta\tau$				
	33,40 ... 39,65 MHz	—	55	80	ns
<b>Impedance at <math>f_N</math></b>					
Input: $Z_{IN} = R_{IN} \parallel C_{IN}$		—	1,0 $\parallel$ 22,2	—	k $\Omega$ $\parallel$ pF
Output: $Z_{OUT} = R_{OUT} \parallel C_{OUT}$		—	2,9 $\parallel$ 7,3	—	k $\Omega$ $\parallel$ pF
<b>Temperature coefficient of frequency</b>	$TC_f$	—	- 94	—	ppm/K

**Frequency response**

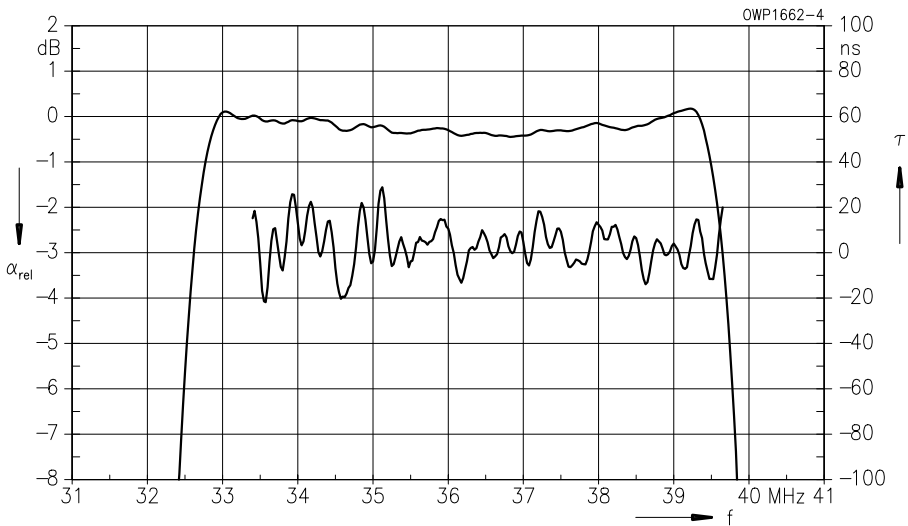
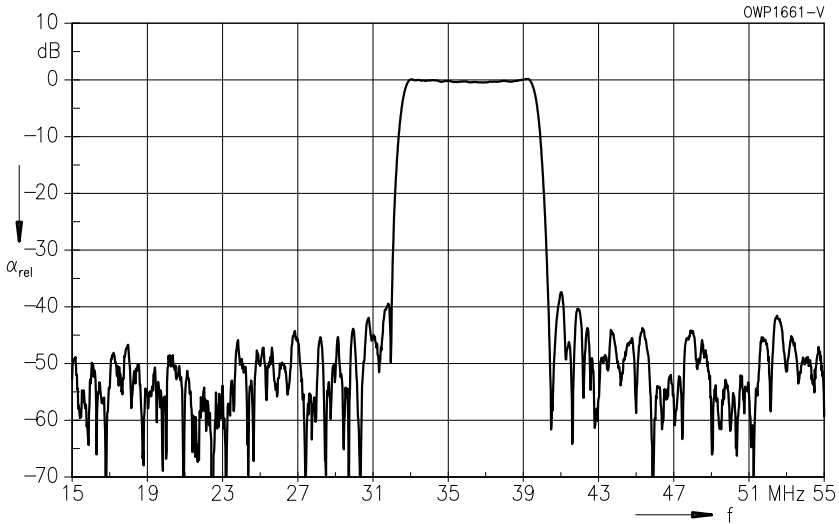

### Standard

- B/G-CCIR  
Germany, Europe partly

### Features

- IF filter for antenna converters
- Full transmission of vestigial sideband and sound carrier
- Group delay predistortion for transmitters

### Terminals

- Tinned CuFe alloy

Plastic package **SIP 5 K**

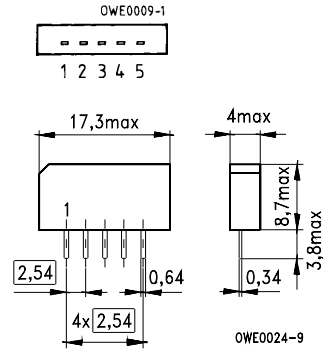

Dimensions in mm, approx. weight 1,0 g

### Pin configuration

- 1 Input
- 2 Input – ground
- 3 Chip carrier – ground
- 4 Output
- 5 Output

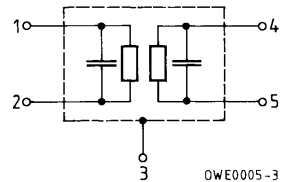

Type	Ordering code	Marking
G 4960 M	B39389-G4960-M100	Type, date code, pin 1

### Maximum ratings

Ambient temperature	$T_A$	- 25/+ 65	°C	—
Storage temperature	$T_{stg}$	- 25/+ 85	°C	—
DC voltage	$V_{DC}$	12	V	between any terminals
AC voltage	$V_{pp}$	10	V	between any terminals

**Characteristics**

Ambient temperature  $T_A = 25\text{ °C}$   
 Source impedance  $Z_S = 50\ \Omega$   
 Load impedance  $Z_L = 2\text{ k}\Omega \parallel 3\text{ pF}$

		min.	typ.	max.	
<b>Insertion attenuation</b>					
Reference level for the following data	38,90 MHz	18,4	19,9	21,4	dB
<b>Relative attenuation</b>					
	39,65 MHz	2,7	3,9	5,1	dB
Sound carrier	33,40 MHz	- 1,2	- 0,2	0,8	dB
2nd sound carrier	33,15 MHz	- 1,4	- 0,4	0,6	dB
Adjacent picture carrier	31,90 MHz	34,0	49,0	—	dB
Adjacent sound carrier	40,40 MHz	32,0	42,0	—	dB
	44,40 MHz	40,0	49,0	—	dB
Lower sidelobe	25,00 ... 31,90 MHz	32,0	42,0	—	dB
Upper sidelobe	40,40 ... 45,00 MHz	32,0	38,0	—	dB
<b>Reflected wave signal suppression</b>					
1,3 $\mu$ s ... 6,0 $\mu$ s after main pulse (test pulse: 250 ns, carrier frequency: 38,90 MHz)		42,0	52,0	—	dB
<b>Feedthrough signal suppression</b>					
1,4 $\mu$ s ... 1,3 $\mu$ s before main pulse (test pulse: 250 ns, carrier frequency: 38,90 MHz)		50,0	56,0	—	dB
<b>Group delay predistortion</b>					
(reference frequency 38,90 MHz)					
	36,90 MHz	—	95	—	ns
	34,47 MHz	—	- 100	—	ns
<b>Impedance at 38,90 MHz</b>					
Input:	$Z_{IN} = R_{IN} \parallel C_{IN}$	—	1,6 $\parallel$ 15,2	—	k $\Omega$ $\parallel$ pF
Output:	$Z_{OUT} = R_{OUT} \parallel C_{OUT}$	—	3,6 $\parallel$ 3,6	—	k $\Omega$ $\parallel$ pF
<b>Temperature coefficient of frequency</b>					
	$TC_f$	—	- 72	—	ppm/K

**Frequency response**

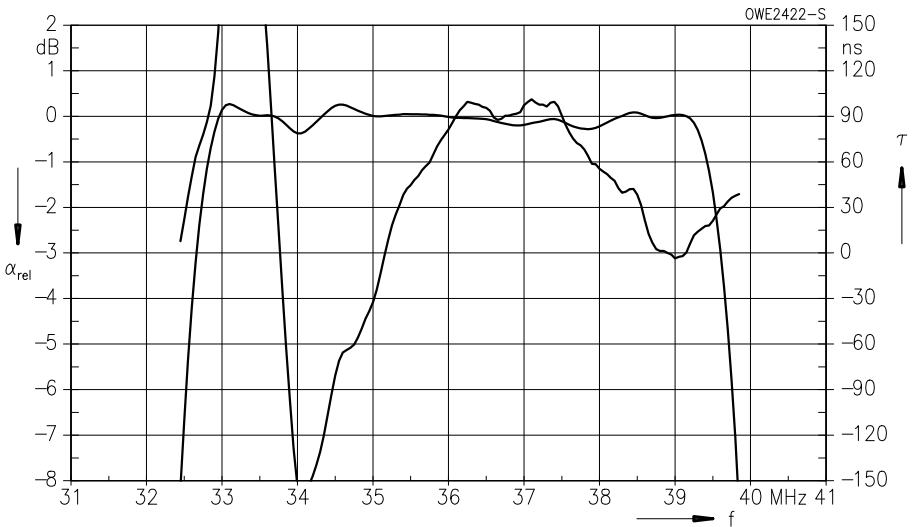
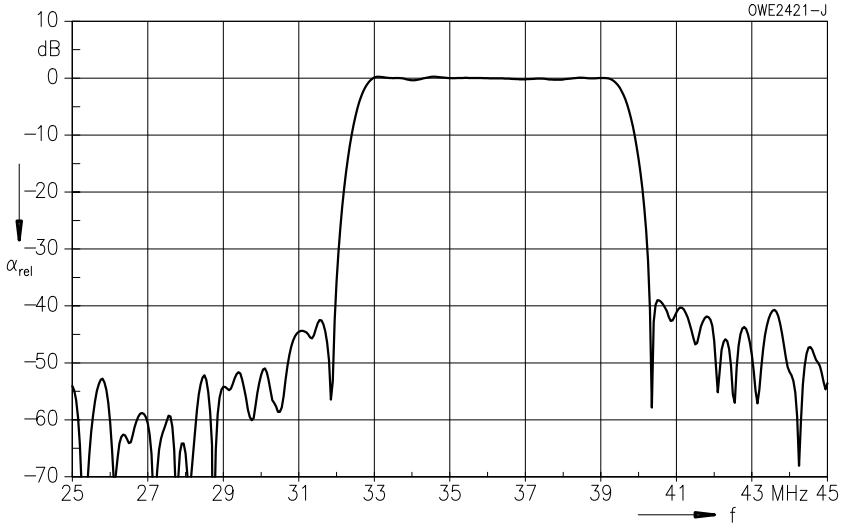



### Standard

- M/N  
USA, South America

### Features

- Vestigial sideband filter with sound suppression
- Constant group delay
- Hermetically sealed metal package

### Terminals

- Gold-plated NiFeCo alloy

Metal package DIP 24-06

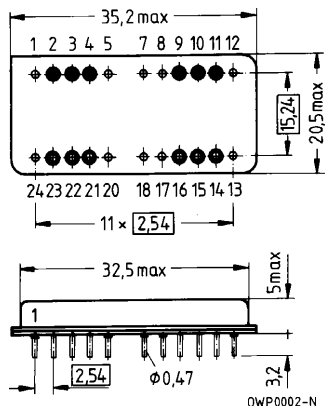

Dimensions in mm, approx. weight 10,4 g

### Pin configuration

- |                    |                 |
|--------------------|-----------------|
| 3                  | Input           |
| 2                  | Input – ground  |
| 15                 | Output          |
| 14                 | Output – ground |
| 1, 5, 7, 8, 12,    |                 |
| 13, 17, 18, 20, 24 | Case – ground   |
| 4, 9, 10, 11,      |                 |
| 16, 21, 22, 23     | Not connected   |

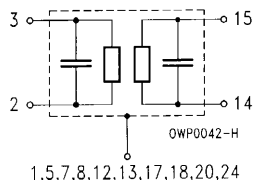

Type	Ordering code	Marking
B 545	B39460-B545-G310	Type, date code, pin 1

Electrostatic Sensitive Device (ESD)

### Maximum ratings

Ambient temperature	$T_A$	- 25/+ 85	°C	—
Storage temperature	$T_{stg}$	- 40/+ 85	°C	—
DC voltage	$V_{DC}$	0	V	—
Source power	$P_s$	15	dBm	source impedance 50 $\Omega$

**B 545**  
**45,75 MHz**

**Characteristics**

Ambient temperature	$T_A = 60\text{ °C}$
Source impedance	$Z_S = 50\ \Omega$
Load impedance	$Z_L = 50\ \Omega$
Group delay aperture	80 kHz

		min.	typ.	max.	
<b>Nominal frequency</b>	$f_N$	—	45,75	—	MHz
<b>Insertion attenuation at <math>f_N</math></b>	$\alpha_N$	26,5	27,5	29,0	dB
<b>Relative attenuation (relative to <math>\alpha_N</math>)</b>	$\alpha_{rel}$				
41,65 MHz		—	1,4	2,0	dB
46,50 MHz		—	1,1	2,0	dB
20,00 ... 40,15 MHz		50,0	55,0	—	dB
40,15 ... 41,20 MHz		45,0	52,0	—	dB
47,00 ... 47,70 MHz		45,0	48,0	—	dB
47,70 ... 60,00 MHz		50,0	54,0	—	dB
<b>Amplitude ripple (p-p)</b>	$\Delta\alpha$				
41,85 ... 46,25 MHz		—	0,3	0,5	dB
<b>Reflected wave signal suppression</b>					
3,5 $\mu$ s ... 13,0 $\mu$ s after main pulse		50,0	63,0	—	dB
<b>Group delay at <math>f_N</math></b>	$\tau_N$	—	4,4	—	$\mu$ s
<b>Group delay ripple (p-p)</b>	$\Delta\tau$				
41,85 ... 46,25 MHz		—	30	50	ns
<b>Temperature coefficient of frequency</b>	$TC_f$	—	- 87	—	ppm/K

**Frequency response**

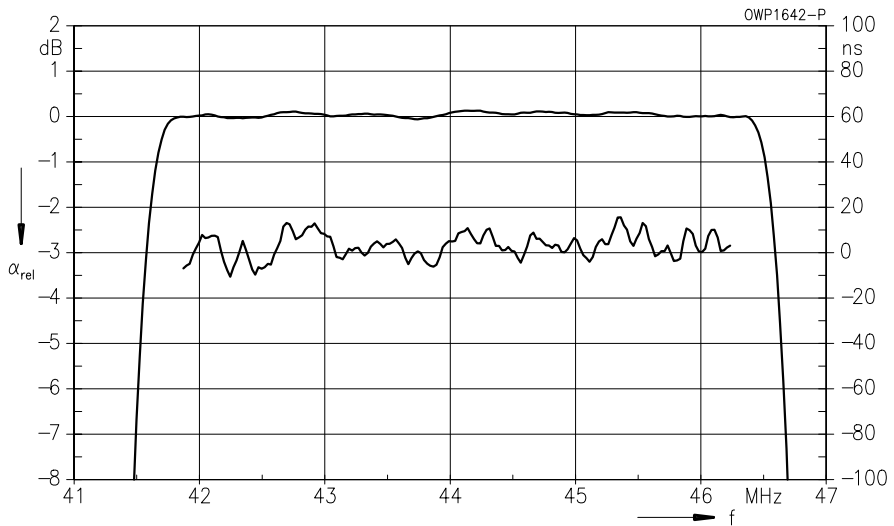
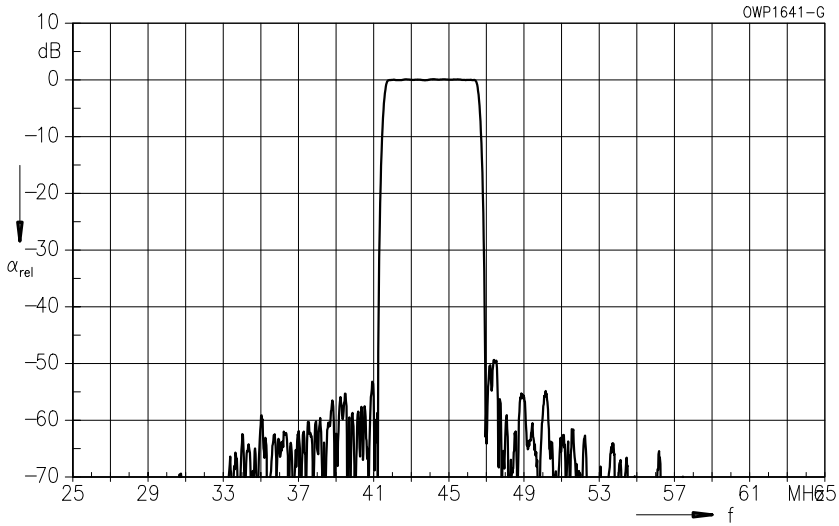



Siemens Matsushita Components

SAW resonators for radio  
remote control

## Making a lot of things a lot easier

The key to convenience and security: radio remote controls for keyless entry in automobiles and opening the garage gate. Or in the household, for cordless headphones or metering heating costs for example. Here the evaporation pipe is replaced by a sensor that signals consumption by



a transmitter to a receiver outside the domicile, thus doing away with readings on all the radiators. Transmitter and receiver are both fitted with a SAW resonator.

**SCS – dependable, fast and competent**



## Spectrum-Shaping Filters

### Survey

$f_c$ <sup>1)</sup> MHz	$f_Y$ MHz	$a$	$p$	$k$	$\alpha$	$\alpha_{rel}$	Package	Type	Page <sup>2)</sup>
70,00	11,95	0,35	0,4	0,0	33	41	DIP 16	B 2540	#
	12,10	0,30	0,5	0,5	34	34	DIP 16	B 2559	#
	12,30	0,33	0,5	0,5	34	40	DIP 16	B 2565	#
	7,755	0,40	0,5	1,0	30	35	DIP 16	B 2569	<a href="#">294</a>
	7,755	0,40	0,5	0,0	27	40	DIP 16	B 2570	<a href="#">297</a>
	13,52	0,34	0,5	0,5	40	54	DIP 24-06	B 2573	#
122,50	13,52	0,32	0,5	0,5	31	50	DIP 16	B 2578	#
157,50	13,52	0,32	0,5	0,5	27	50	DIP 16	B 2579	<a href="#">300</a>
140,00	13,82	0,45	0,5	0,0	27	50	DIP 16	B 2580	#

1) For explanation of symbols see individual data sheets or index on page [347](#)

2) Filters marked by the sign # are only listed in the survey. Detailed information on these types upon request.

**Features**

- Spectrum-shaping filter for digital radio systems
- High-performance passband
- Constant group delay
- Hermetically sealed metal package

**Terminals**

- Gold-plated NiFeCo alloy

Metal package DIP 16

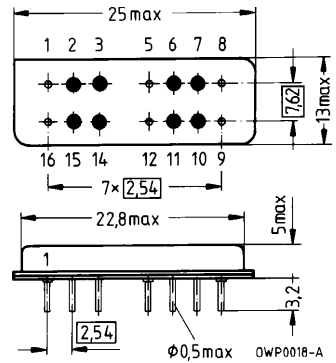

Dimensions in mm, approx. weight 4,2 g

**Pin configuration**

- |                    |                 |
|--------------------|-----------------|
| 3                  | Input           |
| 2                  | Input – ground  |
| 11                 | Output          |
| 10                 | Output – ground |
| 1, 5, 8, 9, 12, 16 | Case – ground   |
| 6, 7, 14, 15       | Not connected   |

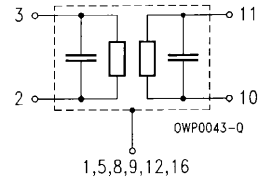

Type	Ordering code	Marking
B 2569	B39700-B2569-E110	Type, date code, pin 1

Electrostatic Sensitive Device (ESD)

**Maximum ratings**

Ambient temperature	$T_A$	- 25/+ 85	°C	—
Storage temperature	$T_{stg}$	- 40/+ 85	°C	—
DC voltage	$V_{DC}$	0	V	—
Source power	$P_s$	15	dBm	source impedance 50 Ω

**Characteristics**

Ambient temperature	$T_A = 25\text{ °C}$
Source impedance	$Z_S = 50\ \Omega$
Load impedance	$Z_L = 50\ \Omega$
Group delay aperture	1 MHz

		min.	typ.	max.	
<b>Center frequency</b> (center between 6 dB points)	$f_c$	69,85	70,0	70,15	MHz
<b>Insertion attenuation at <math>f_c</math></b>	$\alpha_c$	—	30,0	31,0	dB
<b>Deviation</b> from theoretical frequency response $\Delta\alpha$ $f_c \dots f_c \pm 0,8 \cdot f_Y$ $f_c \pm 0,8 \cdot f_Y \dots f_c \pm 1,1 \cdot f_Y$		—	$\pm 0,15$	$\pm 0,2$	dB
		—	$\pm 0,2$	$\pm 0,3$	dB
<b>Relative attenuation</b> (relative to $\alpha_c$ ) 6,00 ... 58,00 MHz 58,00 ... 58,80 MHz 81,20 ... 86,50 MHz 86,50 ... 110,00 MHz	$\alpha_{rel}$	40,0	45,0	—	dB
		35,0	40,0	—	dB
		30,0	35,0	—	dB
		35,0	40,0	—	dB
<b>Reflected wave signal suppression</b> 1,0 $\mu$ s ... 2,7 $\mu$ s after main pulse		50,0	55,0	—	dB
<b>Group delay at <math>f_c</math></b>	$\tau_c$	—	1,54	—	$\mu$ s
<b>Group delay ripple</b> ( $\rho$ -p) 62,00 ... 78,00 MHz	$\Delta\tau$	—	4	7	ns
<b>Nyquist frequency</b>	$f_Y$	—	7,755	—	MHz
<b>Roll-off-factor</b>	$a$	—	0,4	—	
<b>Partitioning factor</b>	$\rho$	—	0,5	—	MHz
<b>sinx/x compensation factor</b>	$k$	—	1,0	—	
<b>Temperature coefficient of frequency</b>	$TC_f$	—	- 87	—	ppm/K

Theoretical frequency response:

$$H(x) = (S(x))^{\rho}/(\text{sinc}(x \cdot \pi/2))^k$$

$$S(x) = \begin{cases} 1 & \text{for } |x| \leq 1 - a \\ (1 + \cos(\pi \cdot (|x| - 1 + a)/2a))/2 & \text{for } 1 - a < |x| < 1 + a \\ 0 & \text{for } |x| \geq 1 + a \end{cases}$$

$$x = (f - f_c)/f_Y$$

**Frequency response**

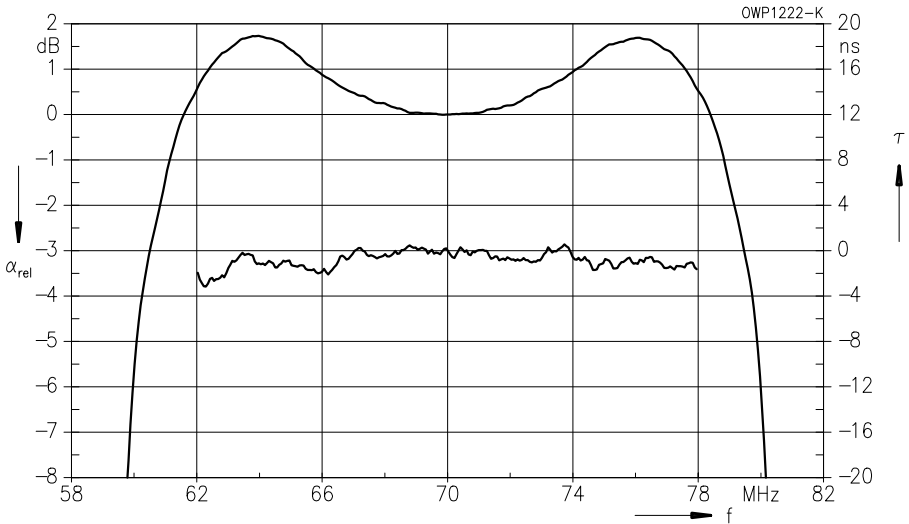
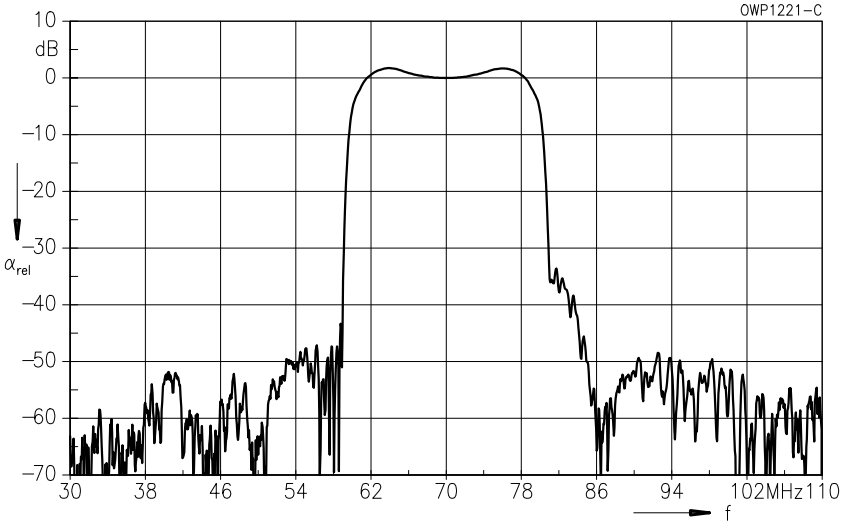



**Features**

- Spectrum-shaping filter for digital radio systems
- High-performance passband
- Constant group delay
- Hermetically sealed metal package

**Terminals**

- Gold-plated NiFeCo alloy

Metal package DIP 16

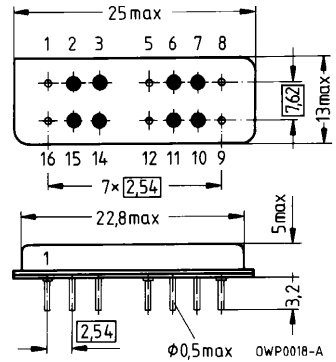

Dimensions in mm, approx. weight 4,2 g

**Pin configuration**

- |                    |                 |
|--------------------|-----------------|
| 3                  | Input           |
| 2                  | Input – ground  |
| 11                 | Output          |
| 10                 | Output – ground |
| 1, 5, 8, 9, 12, 16 | Case – ground   |
| 6, 7, 14, 15       | Not connected   |

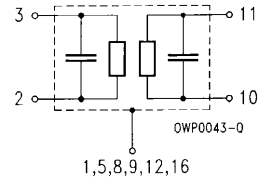

Type	Ordering code	Marking
B 2570	B39700-B2570-E110	Type, date code, pin 1

Electrostatic Sensitive Device (ESD)

**Maximum ratings**

Ambient temperature	$T_A$	- 25/+ 85	°C	—
Storage temperature	$T_{stg}$	- 40/+ 85	°C	—
DC voltage	$V_{DC}$	0	V	—
Source power	$P_s$	15	dBm	source impedance 50 $\Omega$

# B 2570

## 70,00 MHz

### Characteristics

Ambient temperature	$T_A = 25\text{ °C}$
Source impedance	$Z_S = 50\ \Omega$
Load impedance	$Z_L = 50\ \Omega$
Group delay aperture	1 MHz

		min.	typ.	max.	
<b>Center frequency</b> (center between 6 dB points)	$f_c$	69,85	70,0	70,15	MHz
<b>Insertion attenuation at <math>f_c</math></b>	$\alpha_c$	—	27,0	29,0	dB
<b>Deviation</b> from theoretical frequency response $\Delta\alpha$ $f_c \dots f_c \pm 1,05 \cdot f_Y$ $f_c \pm 1,05 \cdot f_Y \dots f_c \pm 1,1 \cdot f_Y$		—	$\pm 0,1$	$\pm 0,2$	dB
		—	$\pm 0,15$	$\pm 0,3$	dB
<b>Relative attenuation</b> (relative to $\alpha_c$ ) 6,00 ... 58,80 MHz 81,20 ... 88,00 MHz 88,00 ... 110,00 MHz	$\alpha_{rel}$	40,0	45,0	—	dB
		35,0	40,0	—	dB
		40,0	45,0	—	dB
<b>Reflected wave signal suppression</b> 0,9 $\mu$ s ... 4,5 $\mu$ s after main pulse		50,0	55,0	—	dB
<b>Group delay</b> at $f_c$	$\tau_c$	—	1,45	—	$\mu$ s
<b>Group delay ripple</b> (p-p) 62,00 ... 78,00 MHz	$\Delta\tau$	—	3	6	ns
		—	3	6	ns
<b>Nyquist frequency</b>	$f_Y$	—	7,755	—	MHz
<b>Roll-off-factor</b>	$a$	—	0,4	—	
<b>Partitioning factor</b>	$\rho$	—	0,5	—	
<b>Temperature coefficient of frequency</b>	$TC_f$	—	- 87	—	ppm/K

Theoretical frequency response:

$$H(x) = (S(x))^p$$

$$S(x) = \begin{cases} 1 & \text{for } |x| \leq 1 - a \\ (1 + \cos(\pi \cdot (|x| - 1 + a)/2a))/2 & \text{for } 1 - a < |x| < 1 + a \\ 0 & \text{for } |x| \geq 1 + a \end{cases}$$

$$x = (f - f_c)/f_Y$$

**Frequency response**

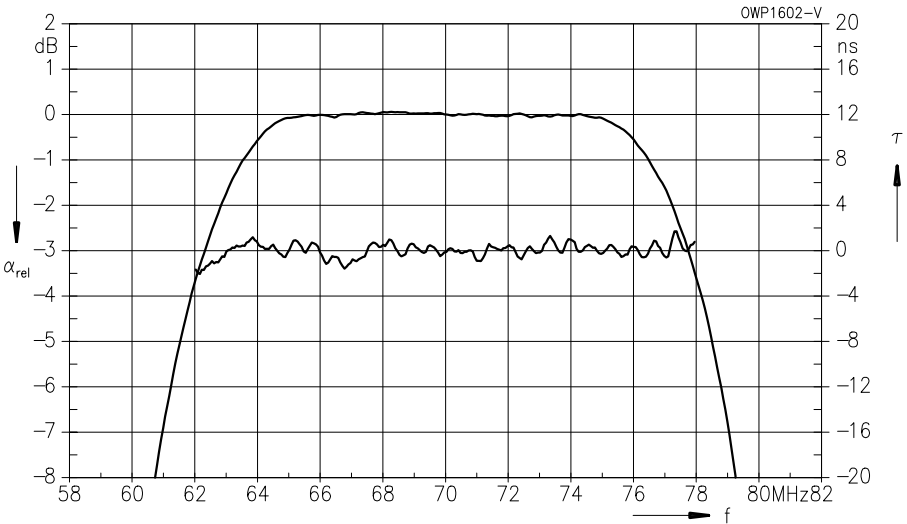
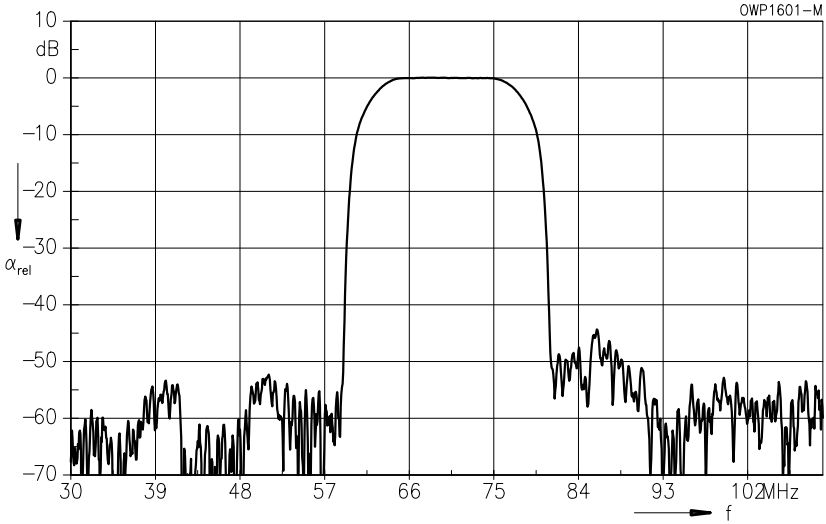

**Features**

- Spectrum-shaping filter for digital radio systems
- High-performance passband
- Constant group delay
- Hermetically sealed metal package

**Terminals**

- Gold-plated NiFeCo alloy

Metal package DIP 16

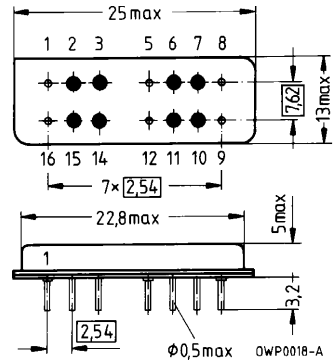

Dimensions in mm, approx. weight 4,2 g

**Pin configuration**

- |                    |                 |
|--------------------|-----------------|
| 3                  | Input           |
| 2                  | Input – ground  |
| 11                 | Output          |
| 10                 | Output – ground |
| 1, 5, 8, 9, 12, 16 | Case – ground   |
| 6, 7, 14, 15       | Not connected   |

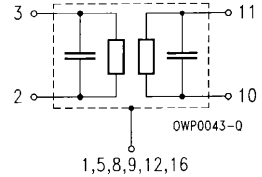

Type	Ordering code	Marking
B 2579	B39161-B2579-E110	Type, date code, pin 1

Electrostatic Sensitive Device (ESD)

**Maximum ratings**

Ambient temperature	$T_A$	- 25/+ 85	°C	—
Storage temperature	$T_{stg}$	- 40/+ 85	°C	—
DC voltage	$V_{DC}$	0	V	—
Source power	$P_s$	15	dBm	source impedance 50 Ω

**Characteristics**

Ambient temperature  $T_A = 45\text{ °C}$   
 Source impedance  $Z_S = 50\ \Omega$   
 Load impedance  $Z_L = 50\ \Omega$

		min.	typ.	max.	
<b>Center frequency</b> (center between 6 dB points)	$f_c$	157,30	157,50	157,70	MHz
<b>Insertion attenuation at <math>f_c</math></b>	$\alpha_c$	25,8	26,8	27,8	dB
<b>Deviation</b> from theoretical frequency response (tilt removed)	$\Delta\alpha$				
	$f_c \dots f_c \pm f_Y$	—	$\pm 0,1$	$\pm 0,2$	dB
<b>Pass band tilt</b>		—	0,02	—	dB/MHz
<b>Deviation</b> from linear phase	$\Delta\phi$				
	$f_c \dots f_c \pm f_Y$	—	$\pm 0,75$	$\pm 1,0$	°
<b>Relative attenuation</b> (relative to $\alpha_c$ )	$\alpha_{rel}$				
	85,00 ... 138,00 MHz	43,0	50,0	—	dB
	177,00 ... 215,00 MHz	41,0	50,0	—	dB
<b>Reflected wave signal suppression</b> 0,8 $\mu$ s ... 4,8 $\mu$ s after main pulse		50,0	55,0	—	dB
<b>Group delay at <math>f_c</math></b>	$\tau_c$	—	1,23	—	$\mu$ s
<b>Nyquist frequency</b>	$f_Y$	—	13,52	—	MHz
<b>Roll-off-factor</b>	$a$	—	0,32	—	
<b>Partitioning factor</b>	$\rho$	—	0,5	—	
<b>sinx/x compensation factor</b>	$k$	—	0,5	—	
<b>Temperature coefficient of frequency</b>	$TC_f$	—	-87	—	ppm/K

Theoretical frequency response:

$$H(x) = (S(x))^{\rho} / (\text{sinc}(x \cdot \pi/2))^k$$

$$S(x) = \begin{cases} 1 & \text{for } |x| \leq 1 - a \\ (1 + \cos(\pi \cdot (|x| - 1 + a)/2a))/2 & \text{for } 1 - a < |x| < 1 + a \\ 0 & \text{for } |x| \geq 1 + a \end{cases}$$

$$x = (f - f_c)/f_Y$$

**B 2579**  
**157,50 MHz**

**Frequency response**

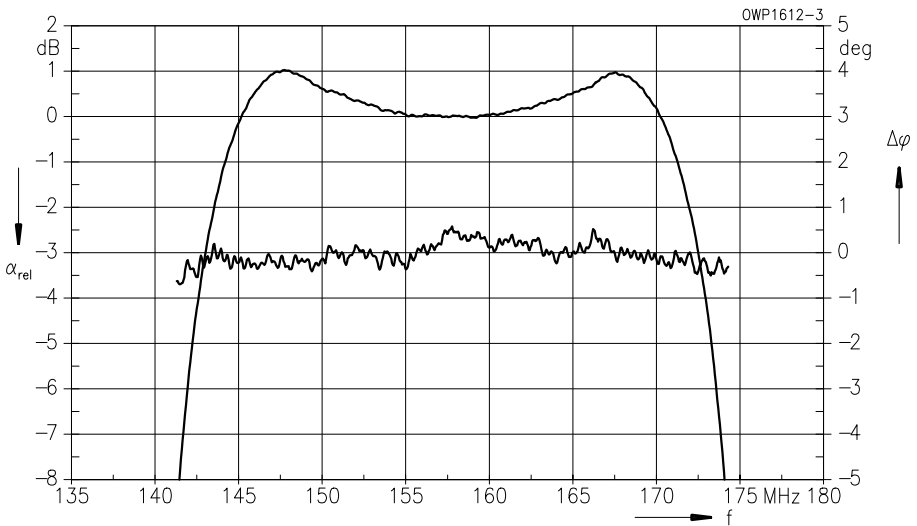
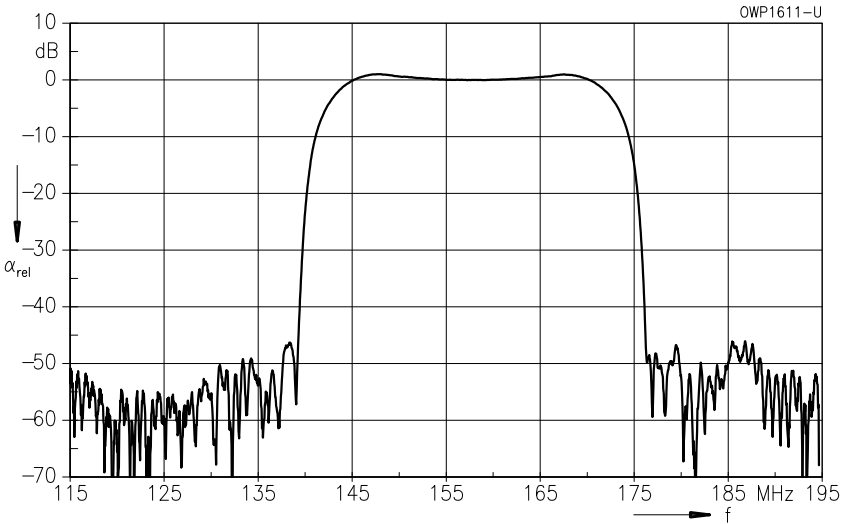

## Bandpass Filters

### Survey

$f_c$ <sup>1)</sup> MHz	$B_{3dB}$ MHz	$B_{40dB}$ MHz	$\alpha_{rel}$ (min.) dB	Standard <sup>2)</sup>	Package	Type	Page <sup>3)</sup>
36,00	1,35	2,25 <sup>4)</sup>	30	DAB	SIP 6 M	B 589	#
36,20	2,7	4,0 <sup>4)</sup>	32	DCR	SIP 5 K	X 6967 M	#
38,912	1,25	2,1 <sup>4)</sup>	28	DAB	SIP 6 M	B 512	<a href="#">304</a>
44,00	1,7	2,9 <sup>4)</sup>	34	Interactive TV	SIP 5 K	X 6959 M	<a href="#">307</a>
45,00	0,27	0,81	50	GSM	DIP 24-03	B 1507	#
60,00	20,1	24,1 <sup>4)</sup>	33	DSS	SIP 5 K	X 6956 M	<a href="#">310</a>
70,00	1,62	3,79	38	—	DIP 16	B 504	<a href="#">313</a>
	11,3	7,5	43	—	DIP 16	B 519	#
	2,5	4,0	42	—	DIP 16	B 590	#
118,00	11,9	15,55	45	—	DIP 16	B 521	<a href="#">316</a>
140,00	2,6	7,0	42	—	DIP 16	B 1529	#
287,35	1,07	2,6 <sup>4)</sup>	39	—	DIP 16	B 1505	<a href="#">319</a>
439,85	1,9	4,1	40	—	TO 8	B 558	<a href="#">322</a>

1) For explanation of symbols see individual data sheets or index on page [347](#)

2) For explanation of standards see individual data sheets or index on page [349](#)

3) Filters marked by the sign # are only listed in the survey. Detailed information on these types upon request.

4) 30 dB bandwidth

## Standard

- DAB  
Digital audio broadcasting

Metal package SIP 6 M

## Features

- Bandpass filter for DAB applications
- Constant group delay
- Hermetically sealed metal package

## Terminals

- Tinned NiFeCo alloy

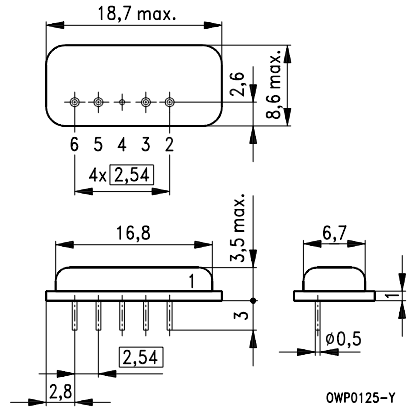

Dimensions in mm, approx. weight 3,0 g

## Pin configuration

- 2 Input
- 3 Input – ground
- 5 Output
- 6 Output
- 4 Case – ground

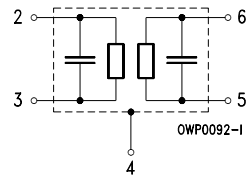

Type	Ordering code	Marking
B 512	B39390-B512-X110	Type, date code, pin 1

Electrostatic Sensitive Device (ESD)

## Maximum ratings

Ambient temperature	$T_A$	- 25/+ 85	°C	—
Storage temperature	$T_{stg}$	- 40/+ 85	°C	—
DC voltage	$V_{DC}$	0	V	—
Source power	$P_s$	15	dBm	source impedance 50 $\Omega$



**Characteristics**

Ambient temperature  $T_A = 25\text{ °C}$   
 Source impedance  $Z_S = 50\ \Omega$  and matching network  
 Load impedance  $Z_L = 50\ \Omega$  and matching network  
 Group delay aperture 80 kHz

		min.	typ.	max.	
<b>Nominal frequency</b>	$f_N$	—	38,912	—	MHz
<b>Insertion attenuation at <math>f_N</math></b>	$\alpha_N$	—	22,00	—	dB
<b>Pass bandwidth</b>					
$\alpha_{rel} \leq 3\text{ dB}$	$B_{3\text{dB}}$	1,15	1,25	1,35	MHz
$\alpha_{rel} \leq 10\text{ dB}$	$B_{10\text{dB}}$	—	1,60	1,75	MHz
$\alpha_{rel} \leq 20\text{ dB}$	$B_{20\text{dB}}$	—	1,90	2,05	MHz
$\alpha_{rel} \leq 30\text{ dB}$	$B_{30\text{dB}}$	—	2,10	—	MHz
<b>Relative attenuation (relative to <math>\alpha_N</math>)</b>					
Lower sidelobe	30,00 ... 37,40 MHz	$\alpha_{rel}$ 38,00	41,00	—	dB
Upper sidelobe	40,40 ... 42,40 MHz	28,00	31,00	—	dB
	42,40 ... 50,00 MHz	34,00	37,00	—	dB
<b>Reflected wave signal suppression</b>					
	2,0 $\mu\text{s}$ ... 6,0 $\mu\text{s}$ after main pulse	40,0	45,0	—	dB
<b>Group delay at <math>f_N</math></b>	$\tau_N$	—	1,75	—	$\mu\text{s}$
<b>Group delay ripple (p-p)</b>	38,30 ... 39,50 MHz $\Delta\tau$	—	25	—	ns
<b>Temperature coefficient of frequency</b>	$TC_f$	—	-0,035	—	ppm/K <sup>2</sup>

Matching network:

Input: Serial coil; L 1 = 3,3  $\mu\text{H}$ , Q = 30

Output: Serial coil; L 2 = 6,8  $\mu\text{H}$ , Q = 30

**Frequency response**

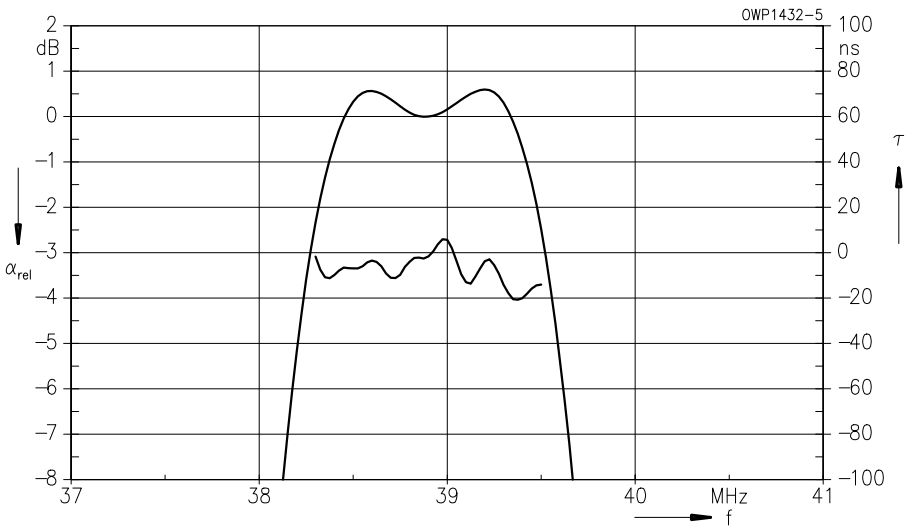
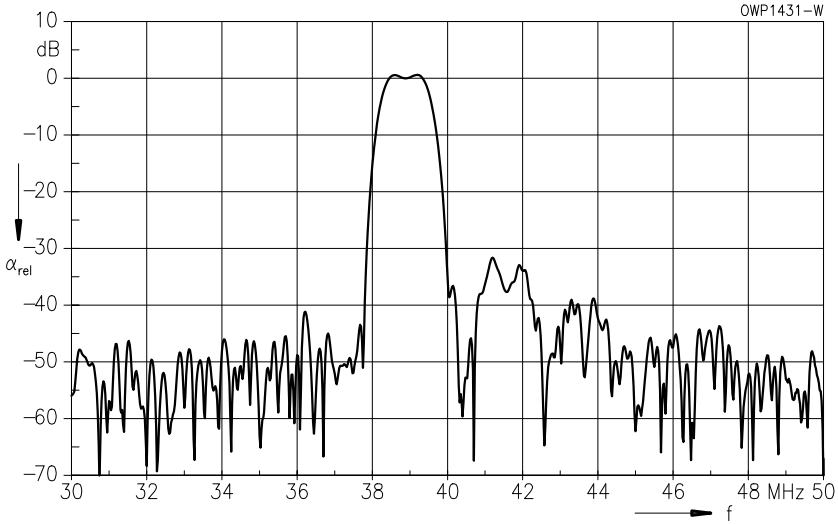

### Standard

- Interactive TV

### Features

- IF filter for Interactive TV applications
- Low group delay ripple

### Terminals

- Tinned CuFe alloy

Plastic package **SIP 5 K**

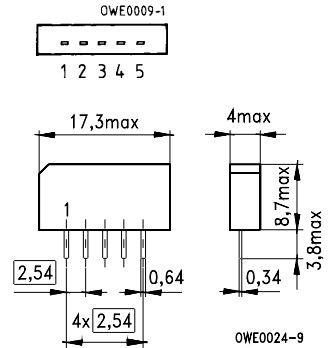

Dimensions in mm, approx. weight 1,0 g

### Pin configuration

- 1 Input
- 2 Input – ground
- 3 Chip carrier – ground
- 4 Output
- 5 Output

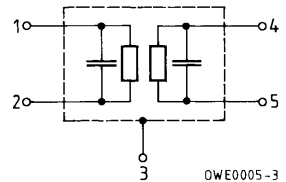

Type	Ordering code	Marking
X 6959 M	B39440-X6959-M100	Type, date code, pin 1

### Maximum ratings

Ambient temperature	$T_A$	- 25/+ 65	°C	—
Storage temperature	$T_{stg}$	- 25/+ 85	°C	—
DC voltage	$V_{DC}$	12	V	between any terminals
AC voltage	$V_{pp}$	10	V	between any terminals

# X 6959 M

## 44,00 MHz

### Characteristics

Ambient temperature	$T_A = 25\text{ °C}$
Source impedance	$Z_S = 50\ \Omega$
Load impedance	$Z_L = 2\text{ k}\Omega \parallel 3\text{ pF}$
Group delay aperture	50 kHz

		min.	typ.	max.	
<b>Center frequency</b> (center between 3 dB points)	$f_c$	—	44,00	—	MHz
<b>Insertion attenuation</b> Reference level for the following data	44,00 MHz $\alpha$	13,5	15,0	16,5	dB
<b>Pass bandwidth</b> $\alpha_{\text{rel}} \leq 3\text{ dB}$ $\alpha_{\text{rel}} \leq 6\text{ dB}$ $\alpha_{\text{rel}} \leq 30\text{ dB}$	$B_{3\text{dB}}$ $B_{6\text{dB}}$ $B_{30\text{dB}}$	— — —	1,70 2,00 2,90	— — —	MHz MHz MHz
<b>Relative attenuation</b> Lower sidelobe Upper sidelobe	$\alpha_{\text{rel}}$ 35,00 ... 41,30 MHz 41,30 ... 42,30 MHz 45,80 ... 47,20 MHz 47,20 ... 55,00 MHz	40,0 36,0 34,0 40,0	45,0 41,0 40,0 46,0	— — — —	dB dB dB dB
<b>Group delay ripple (p-p)</b>	$\Delta\tau$ 43,00 ... 45,00 MHz	—	45	—	ns
<b>Impedance at 44,00 MHz</b> Input: $Z_{\text{IN}} = R_{\text{IN}} \parallel C_{\text{IN}}$ Output: $Z_{\text{OUT}} = R_{\text{OUT}} \parallel C_{\text{OUT}}$		— —	1,6 $\parallel$ 12,0 0,8 $\parallel$ 3,8	— —	k $\Omega$ $\parallel$ pF k $\Omega$ $\parallel$ pF
<b>Temperature coefficient of frequency</b>	$TC_f$	—	-72	—	ppm/K

Frequency response

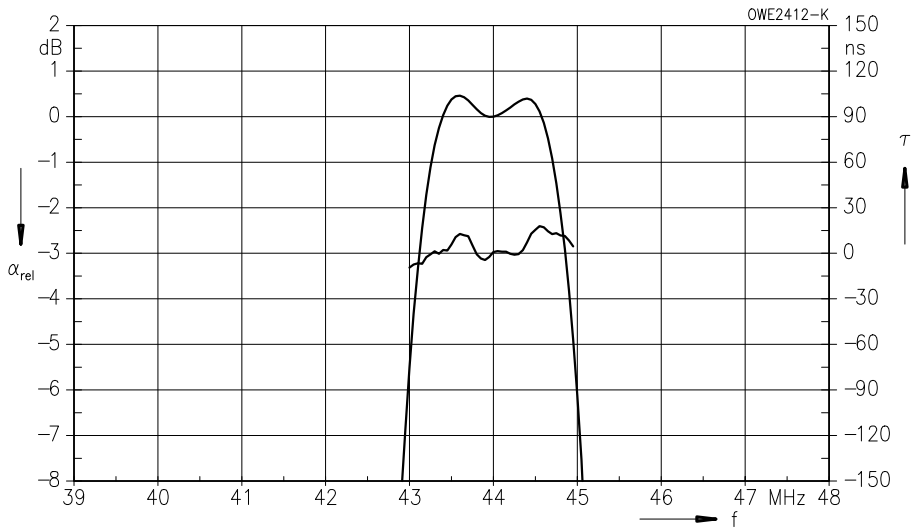
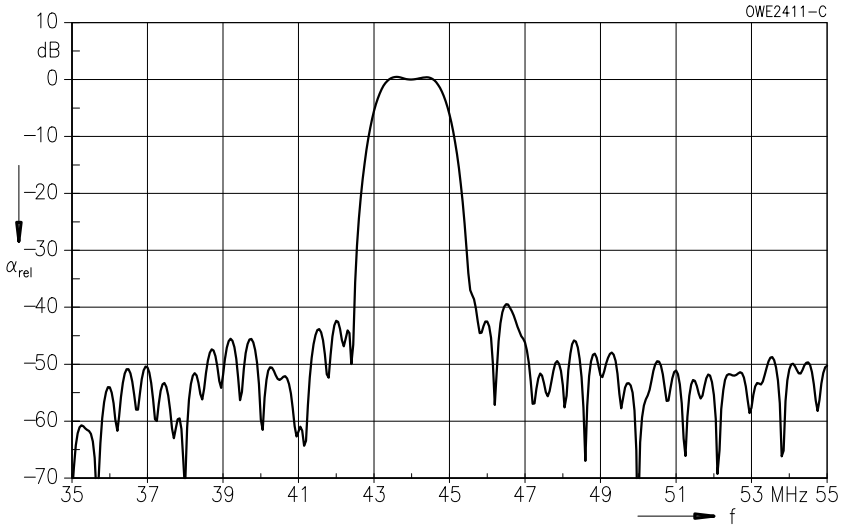

### Standard

- DSS  
Digital satellite system

### Features

- IF filter for DSS receivers
- Constant group delay

### Terminals

- Tinned CuFe alloy

Plastic package **SIP 5 K**

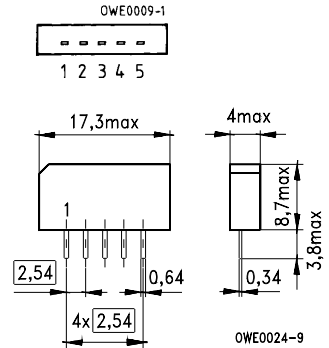

Dimensions in mm, approx. weight 1,0 g

### Pin configuration

- 1 Input
- 2 Input – ground
- 3 Chip carrier – ground
- 4 Output
- 5 Output

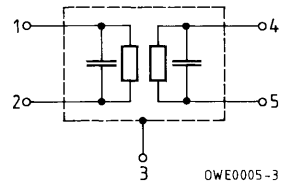

Type	Ordering code	Marking
X 6956 M	B39600-X6956-M100	Type, date code, pin 1

### Maximum ratings

Ambient temperature	$T_A$	- 25/+ 65	°C	—
Storage temperature	$T_{stg}$	- 25/+ 85	°C	—
DC voltage	$V_{DC}$	12	V	between any terminals
AC voltage	$V_{pp}$	10	V	between any terminals

**Characteristics**

Ambient temperature	$T_A = 25\text{ °C}$
Source impedance	$Z_S = 50\ \Omega$
Load impedance	$Z_L = 2\text{ k}\Omega \parallel 3\text{ pF}$
Group delay aperture	3,6 MHz

		min.	typ.	max.	
<b>Insertion attenuation</b>	$\alpha$				
Reference level for the following data	60,00 MHz	25,5	27,0	28,5	dB
<b>Center frequency</b>	$f_c$				
(center between 3 dB points)		59,88	60,00	60,12	MHz
<b>Relative attenuation</b>	$\alpha_{rel}$				
Passband ripple	52,00 ... 68,00 MHz	—	0,35	0,70	dB
Lower sidelobe	40,00 ... 47,50 MHz	34,0	40,0	—	dB
Upper sidelobe	72,50 ... 80,00 MHz	33,0	40,0	—	dB
<b>Pass bandwidth</b>					
$\alpha_{rel} \leq 3\text{ dB}$	$B_{3\text{dB}}$	19,65	20,15	20,65	MHz
$\alpha_{rel} \leq 30\text{ dB}$	$B_{30\text{dB}}$	23,65	24,14	24,65	MHz
<b>Stopband alpha</b>		—	0,20	—	
<b>Reflected wave signal suppression</b>					
0,8 $\mu\text{s}$ ... 6,0 $\mu\text{s}$ after main pulse (test pulse: 250 ns, carrier frequency: 60,00 MHz)		44,0	56,0	—	dB
<b>Feedthrough signal suppression</b>					
1,1 $\mu\text{s}$ ... 1,0 $\mu\text{s}$ before main pulse (test pulse: 250 ns, carrier frequency: 60,00 MHz)		—	56,0	—	dB
<b>Group delay ripple (p-p)</b>	$\Delta\tau$				
51,50 ... 68,50 MHz		—	3	4	ns
<b>Impedance at 60,00 MHz</b>					
Input: $Z_{IN} = R_{IN} \parallel C_{IN}$		—	2,2 $\parallel$ 12,0	—	k $\Omega$ $\parallel$ pF
Output: $Z_{OUT} = R_{OUT} \parallel C_{OUT}$		—	2,2 $\parallel$ 3,1	—	k $\Omega$ $\parallel$ pF
<b>Temperature coefficient of frequency</b>	$TC_f$	—	-72	—	ppm/K

Frequency response

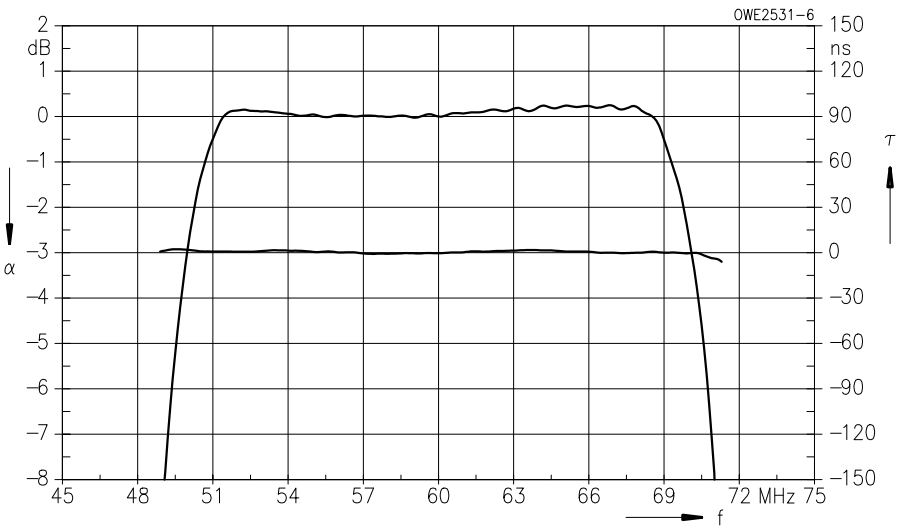
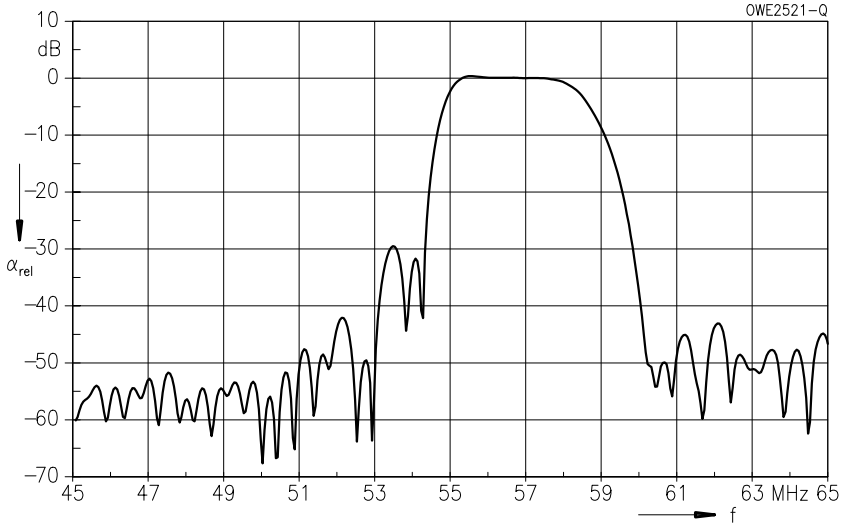



### Features

- High-performance IF bandpass filter
- Constant group delay
- Hermetically sealed metal package

### Terminals

- Gold-plated NiFeCo alloy

Metal package DIP 16

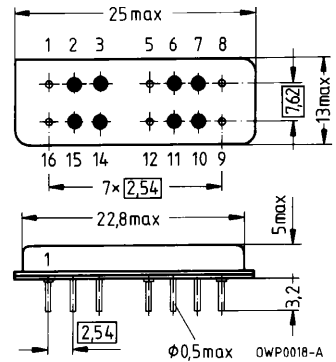

Dimensions in mm, approx. weight 4,2 g

### Pin configuration

- |                    |                 |
|--------------------|-----------------|
| 3                  | Input           |
| 2                  | Input – ground  |
| 11                 | Output          |
| 10                 | Output – ground |
| 1, 5, 8, 9, 12, 16 | Case – ground   |
| 6, 7, 14, 15       | Not connected   |

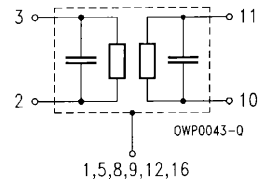

Type	Ordering code	Marking
B 504	B39700-B504-E110	Type, date code, pin 1

Electrostatic Sensitive Device (ESD)

### Maximum ratings

Ambient temperature	$T_A$	- 25/+ 85	°C	—
Storage temperature	$T_{stg}$	- 40/+ 85	°C	—
DC voltage	$V_{DC}$	0	V	—
Source power	$P_s$	15	dBm	source impedance 50 Ω

# B 504

## 70,00 MHz

### Characteristics

Ambient temperature	$T_A = 25\text{ °C}$
Source impedance	$Z_S = 50\ \Omega$
Load impedance	$Z_L = 50\ \Omega$
Group delay aperture	400 kHz

		min.	typ.	max.	
<b>Center frequency</b> (center between 3 dB points)	$f_c$	69,96	70,00	70,04	MHz
<b>Insertion attenuation at <math>f_c</math></b>	$\alpha_c$	38,3	39,3	40,3	dB
<b>Pass bandwidth</b>					
$\alpha_{rel} \leq 1\text{ dB}$	$B_{1\text{dB}}$	1,03	1,08	1,13	MHz
$\alpha_{rel} \leq 3\text{ dB}$	$B_{3\text{dB}}$	1,57	1,62	1,67	MHz
$\alpha_{rel} \leq 40\text{ dB}$	$B_{40\text{dB}}$	3,74	3,79	3,84	MHz
<b>Amplitude ripple (p-p)</b> 69,70 ... 70,30 MHz		—	0,3	0,4	dB
<b>Relative attenuation (relative to <math>\alpha_c</math>)</b>					
25,00 ... 67,90 MHz	$\alpha_{rel}$	50,0	54,0	—	dB
72,10 ... 77,00 MHz		38,0	40,0	—	dB
77,00 ... 100,00 MHz		46,0	52,0	—	dB
<b>Reflected wave signal suppression</b>					
1,1 $\mu\text{s}$ ... 6,1 $\mu\text{s}$ after main pulse		55,0	62,0	—	dB
<b>Group delay at <math>f_c</math></b>	$\tau_c$	—	2,0	—	$\mu\text{s}$
<b>Group delay ripple (p-p)</b>					
68,70 ... 71,30 MHz	$\Delta\tau$	—	4	10	ns
<b>Temperature coefficient of frequency</b>	$TC_f$	—	- 0,035	—	ppm/K <sup>2</sup>
<b>Frequency inversion temperature</b>	$T_0$	—	25	—	°C

Temperature dependance of  $f_c$ :  $f_c(T_A) = f_c(T_0) (1 + TC_f(T_A - T_0)^2)$

**Frequency response**

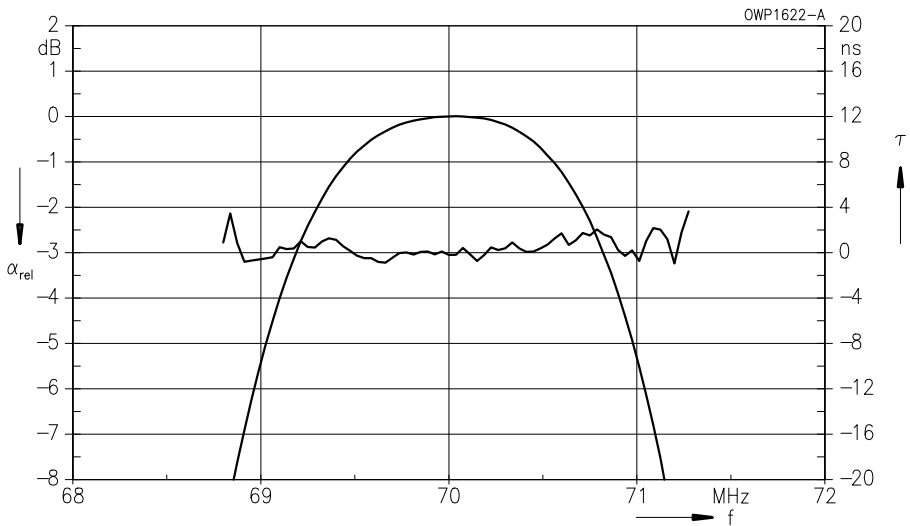
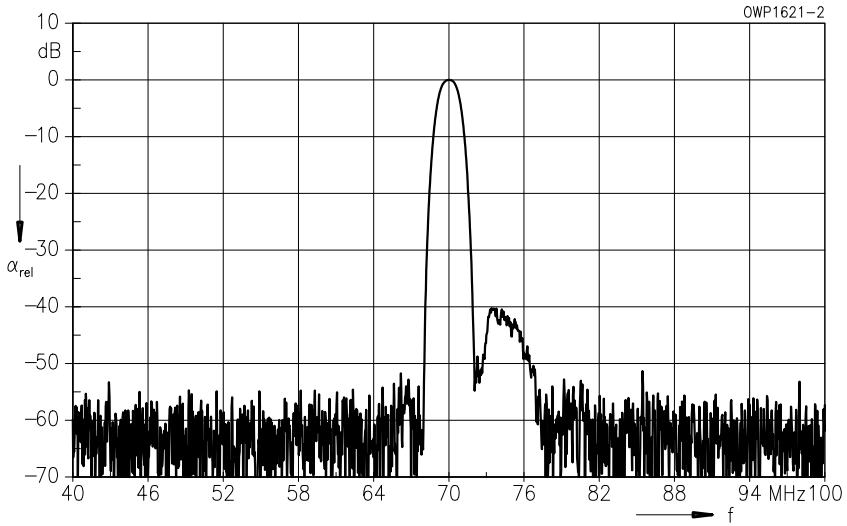

### Features

- High-performance IF bandpass filter
- Constant group delay
- Hermetically sealed metal package

### Terminals

- Gold-plated NiFeCo alloy

Metal package DIP 16

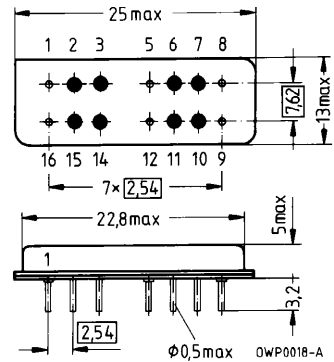

Dimensions in mm, approx. weight 4,2 g

### Pin configuration

- |                    |                 |
|--------------------|-----------------|
| 3                  | Input           |
| 2                  | Input – ground  |
| 11                 | Output          |
| 10                 | Output – ground |
| 1, 5, 8, 9, 12, 16 | Case – ground   |

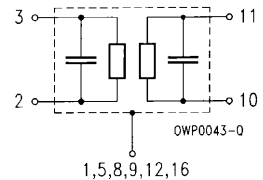

Type	Ordering code	Marking
B 521	B39121-B521-E110	Type, date code, pin 1

Electrostatic Sensitive Device (ESD)

### Maximum ratings

Ambient temperature	$T_A$	- 25/+ 85	°C	—
Storage temperature	$T_{stg}$	- 40/+ 85	°C	—
DC voltage	$V_{DC}$	0	V	—
Source power	$P_s$	15	dBm	source impedance 50 $\Omega$

**Characteristics**

Ambient temperature	$T_A = 35\text{ °C}$
Source impedance	$Z_S = 50\ \Omega$
Load impedance	$Z_L = 50\ \Omega$
Group delay aperture	200 kHz

		min.	typ.	max.	
<b>Center frequency</b> (center between 3 dB points)	$f_c$	117,80	118,00	118,20	MHz
<b>Insertion attenuation at <math>f_c</math></b>	$\alpha_c$	20,0	22,0	24,0	dB
<b>Amplitude ripple (p-p)</b> 112,80 ... 123,00 MHz		—	0,8	1,0	dB
<b>Pass bandwidth</b>					
$\alpha_{rel} \leq 1\text{ dB}$	$B_{1\text{dB}}$	10,7	10,9	11,1	MHz
$\alpha_{rel} \leq 3\text{ dB}$	$B_{3\text{dB}}$	11,8	11,9	12,0	MHz
$\alpha_{rel} \leq 40\text{ dB}$	$B_{40\text{dB}}$	15,4	15,55	15,7	MHz
<b>Relative attenuation (relative to <math>\alpha_c</math>)</b>	$\alpha_{rel}$				
100,00 ... 107,00 MHz		50,0	52,0	—	dB
107,00 ... 108,70 MHz		45,0	48,0	—	dB
108,70 ... 109,80 MHz		50,0	55,0	—	dB
126,20 ... 136,00 MHz		50,0	53,0	—	dB
<b>Reflected wave signal suppression</b> 0,9 $\mu\text{s}$ ... 4,7 $\mu\text{s}$ after main pulse		48,0	52,0	—	dB
<b>Group delay at <math>f_c</math></b>	$\tau_c$	—	1,3	—	$\mu\text{s}$
<b>Group delay ripple (p-p)</b> 112,00 ... 124,00 MHz	$\Delta\tau$	—	25	35	ns
<b>Temperature coefficient of frequency</b>	$TC_f$	—	-87	—	ppm/K

**Frequency response**

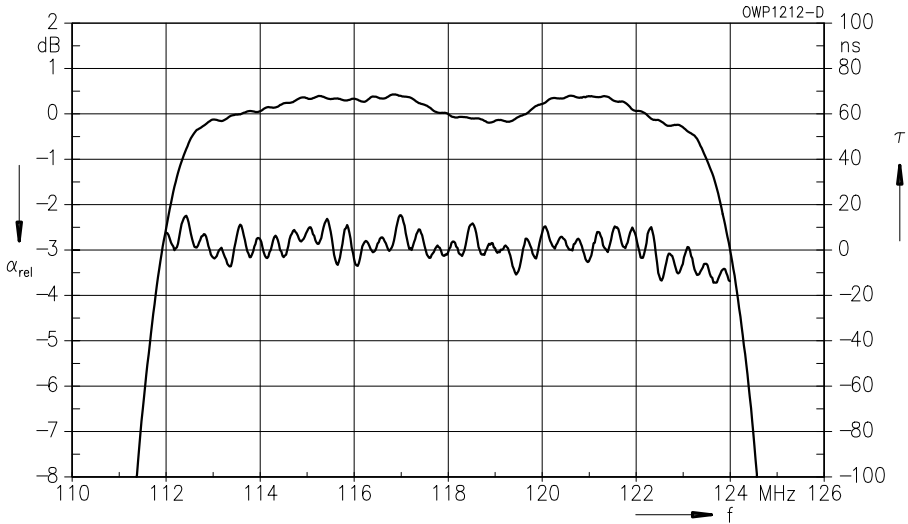
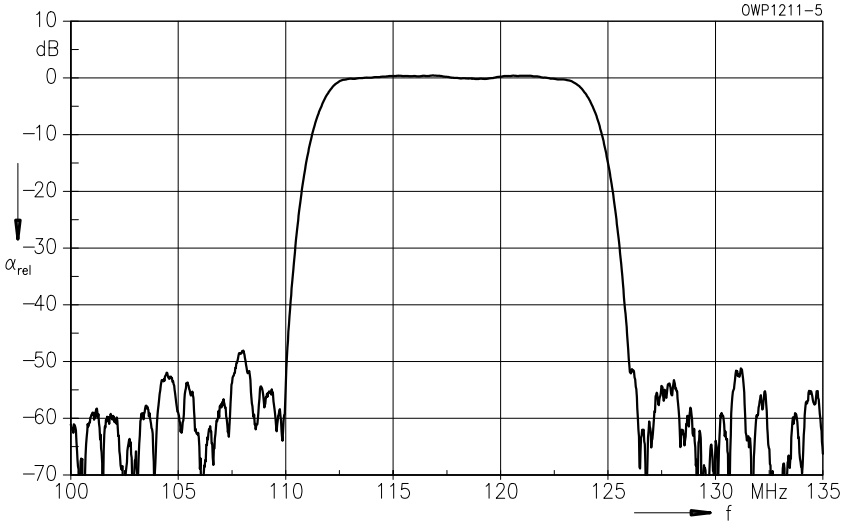

## Features

- High-performance IF bandpass filter
- Constant group delay
- Hermetically sealed metal package

## Terminals

- Gold-plated NiFeCo alloy

Metal package DIP 16

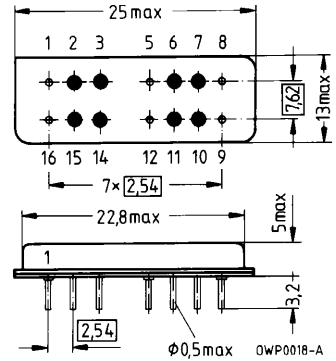

Dimensions in mm, approx. weight 4,2 g

## Pin configuration

- |                    |                 |
|--------------------|-----------------|
| 3                  | Input           |
| 2                  | Input – ground  |
| 11                 | Output          |
| 10                 | Output – ground |
| 1, 5, 8, 9, 12, 16 | Case – ground   |

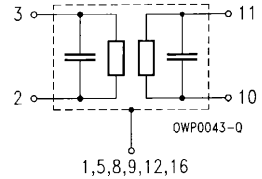

Type	Ordering code	Marking
B 1505	B39291-B1505-E110	Type, date code, pin 1

Electrostatic Sensitive Device (ESD)

## Maximum ratings

Ambient temperature	$T_A$	- 25/+ 85	°C	—
Storage temperature	$T_{stg}$	- 40/+ 85	°C	—
DC voltage	$V_{DC}$	0	V	—
Source power	$P_s$	15	dBm	source impedance 50 Ω

# B 1505

## 287,35 MHz

### Characteristics

Ambient temperature	$T_A = 25\text{ °C}$
Source impedance	$Z_S = 50\ \Omega$
Load impedance	$Z_L = 50\ \Omega$
Group delay aperture	120 kHz

		min.	typ.	max.	
<b>Center frequency</b> (center between 3 dB points)	$f_c$	287,25	287,35	287,45	MHz
<b>Insertion attenuation at <math>f_c</math></b>	$\alpha_c$	19,5	20,5	21,5	dB
<b>Pass bandwidth</b>					
$\alpha_{rel} \leq 1\text{ dB}$	$B_{1\text{dB}}$	0,625	0,645	0,665	MHz
$\alpha_{rel} \leq 3\text{ dB}$	$B_{3\text{dB}}$	1,04	1,07	1,10	MHz
$\alpha_{rel} \leq 30\text{ dB}$	$B_{30\text{dB}}$	2,59	2,62	2,65	MHz
<b>Relative attenuation</b> (relative to $\alpha_c$ )	$\alpha_{rel}$				
45,00 ... 280,00 MHz		55,0	60,0	—	dB
280,00 ... 285,70 MHz		39,0	43,0	—	dB
288,80 ... 295,00 MHz		40,0	43,0	—	dB
295,00 ... 400,00 MHz		48,0	52,0	—	dB
<b>Reflected wave signal suppression</b> 1,4 $\mu\text{s}$ ... 4,6 $\mu\text{s}$ after main pulse		40,0	48,0	—	dB
<b>Group delay at <math>f_c</math></b>	$\tau_c$	—	1,3	—	$\mu\text{s}$
<b>Group delay ripple</b> (p-p) 286,50 ... 288,00 MHz	$\Delta\tau$	—	30	50	ns
<b>Temperature coefficient of frequency</b>	$TC_f$	—	-0,035	—	ppm/K <sup>2</sup>
<b>Frequency inversion temperature</b>	$T_0$	—	20	—	°C

Temperature dependence of  $f_c$ :  $f_c(T_A) = f_c(T_0) (1 + TC_f(T_A - T_0)^2)$



**Frequency response**

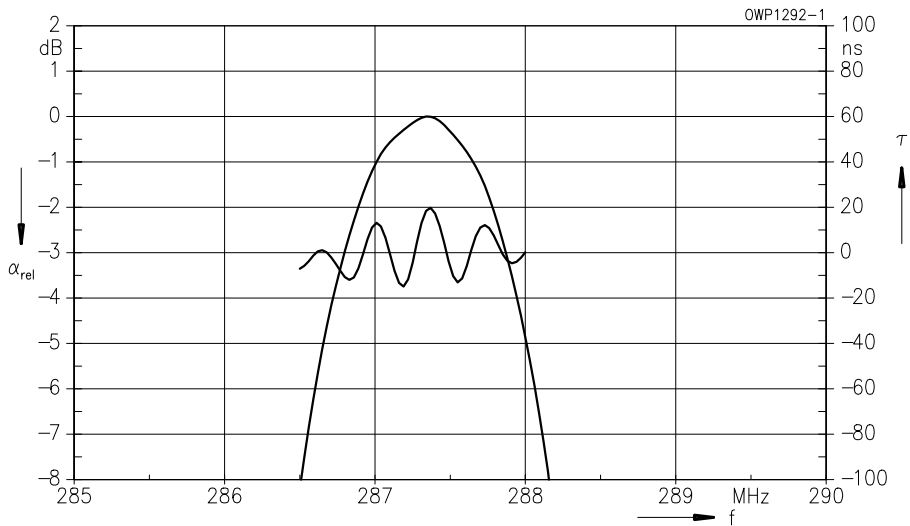
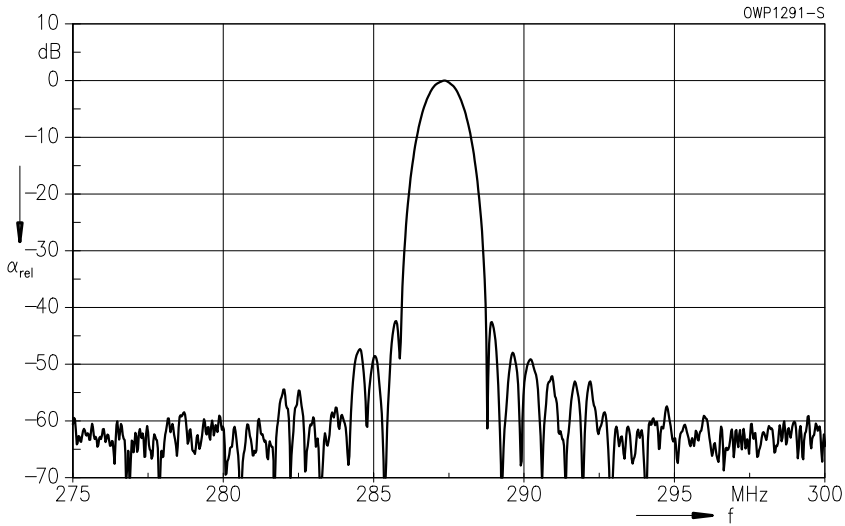

### Features

- High-performance IF bandpass filter
- Constant group delay
- Hermetically sealed metal package

### Terminals

- Gold-plated NiFeCo alloy

Metal package TO 8

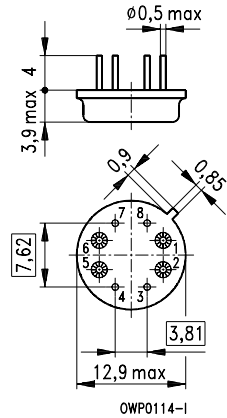

Dimensions in mm, approx. weight 1,7 g

### Pin configuration

- 1 Input
- 2 Input – ground
- 5 Output
- 6 Output – ground
- 3, 4, 7, 8 Case – ground

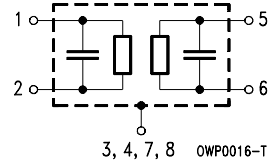

Type	Ordering code	Marking
B 558	B39441-B558-C210	Type, date code

Electrostatic Sensitive Device (ESD)

### Maximum ratings

Ambient temperature	$T_A$	- 25/+ 85	°C	—
Storage temperature	$T_{stg}$	- 40/+ 85	°C	—
DC voltage	$V_{DC}$	0	V	—
Source power	$P_s$	15	dBm	source impedance 50 $\Omega$

**Characteristics**

Ambient temperature	$T_A = 25\text{ °C}$
Source impedance	$Z_S = 50\ \Omega$
Load impedance	$Z_L = 50\ \Omega$
Group delay aperture	100 kHz

		min.	typ.	max.	
<b>Center frequency</b> (center between 3 dB points)	$f_c$	439,6	439,85	440,1	MHz
<b>Insertion attenuation at <math>f_c</math></b>	$\alpha_c$	—	21,0	22,0	dB
<b>Amplitude ripple (p-p)</b> 439,70 ... 440,00 MHz	$\Delta\alpha$	—	0,2	0,4	dB
<b>Pass bandwidth</b>					
$\alpha_{rel} \leq 1\text{ dB}$	$B_{1\text{dB}}$	1,25	1,37	—	MHz
$\alpha_{rel} \leq 3\text{ dB}$	$B_{3\text{dB}}$	1,80	1,90	—	MHz
$\alpha_{rel} \leq 40\text{ dB}$	$B_{40\text{dB}}$	—	4,10	4,30	MHz
<b>Relative attenuation (relative to <math>\alpha_c</math>)</b>	$\alpha_{rel}$				
390,00 ... 434,85 MHz		42,0	47,0	—	dB
434,85 ... 437,50 MHz		40,0	45,0	—	dB
442,20 ... 444,85 MHz		40,0	45,0	—	dB
444,85 ... 490,00 MHz		42,0	47,0	—	dB
<b>Reflected wave signal suppression</b> 1,0 $\mu\text{s}$ ... 3,0 $\mu\text{s}$ after main pulse		40,0	45,0	—	dB
<b>Group delay at <math>f_c</math></b>	$\tau_c$	1050	1090	1130	ns
<b>Group delay ripple (p-p)</b> 439,70 ... 440,00 MHz	$\Delta\tau$	—	20	25	ns
<b>Temperature coefficient of frequency</b>	$TC_f$	—	- 0,03	—	ppm/K <sup>2</sup>
<b>Frequency inversion temperature</b>	$T_0$	10	20	30	°C

Temperature dependence of  $f_c$ :  $f_c(T_A) = f_c(T_0) (1 + TC_f(T_A - T_0)^2)$

**Frequency response**

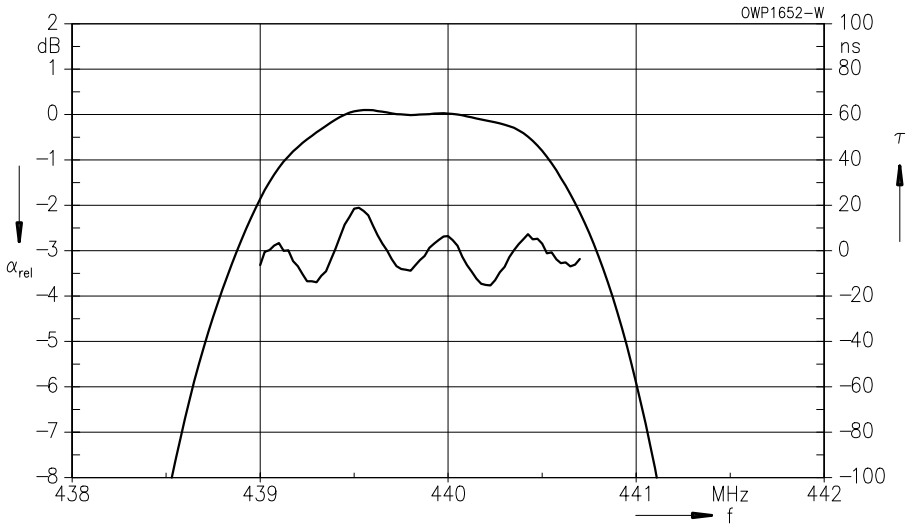
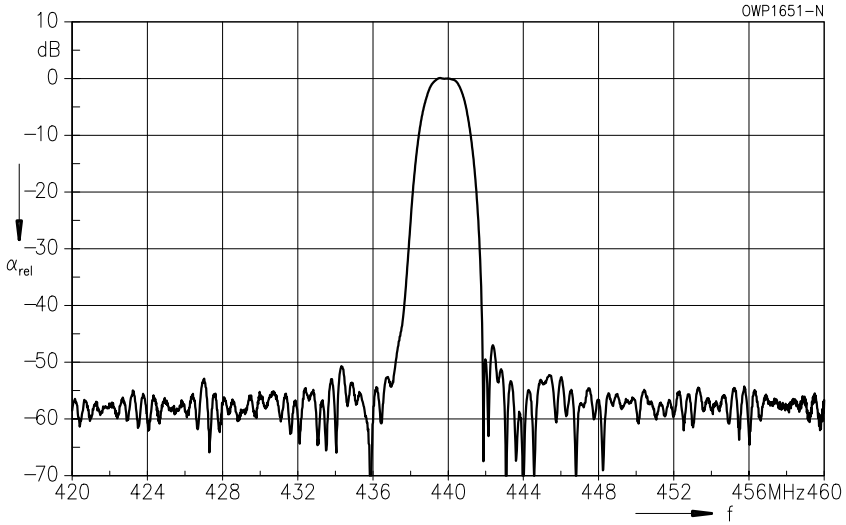

## Clock Recovery Filters

### Survey

$f_c$ <sup>1)</sup>	$\Delta f_c$	$B_{3dB}$	$\alpha_c$ (max.)	$\tau$	Package	Type	Page <sup>2)</sup>
MHz	kHz	kHz	dB	ns			
51,840	± 16	450	29,5	1520	DIP 16	B 5545	#
139,264	± 40	850	21,0	820	TO 8	B 5505	#
155,520	± 31	610	18,5	1130	TO 8	B 5533	<a href="#">326</a>
	± 31	230	19,5	2200	DIP 16	B 5549	#
167,118	± 33	600	17,0	1180	TO 8	B 5506	#
181,043	± 37	600	17,5	1085	TO 8	B 5504	#
622,080	± 150	925	19,5	720	TO 39	B 5531	<a href="#">329</a>
	± 150	2930	20,5	270	TO 8	B 5547	#
659,157	± 157	1460	18,0	580	TO 8	B 5513	#
2488,320	± 870	6300 <sup>3)</sup>	21,0	155	TO 39	B 5534	#

1) For explanation of symbols see individual data sheets or index of symbols on page [347](#)

2) Filters marked by the sign # are only listed in the survey. Detailed information on these types upon request.

3) 6 dB bandwidth

### Features

- Passive or active timing recovery for digital transmission systems
- Hermetically sealed metal package

### Terminals

- Gold-plated NiFeCo alloy

Metal package TO 8

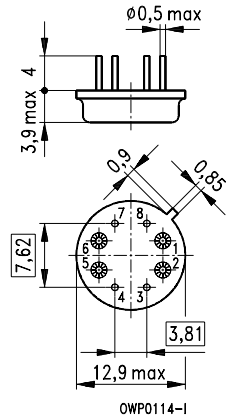

Dimensions in mm, approx. weight 1,7 g

### Pin configuration

- 1 Input
- 2 Input – ground
- 5 Output
- 6 Output – ground
- 3, 4, 7, 8 Case – ground

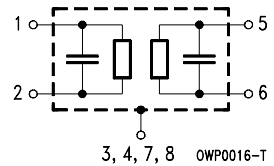

Type	Ordering code	Marking
B 5533	B39161-B5533-C210	Type, date code

Electrostatic Sensitive Device (ESD)

### Maximum ratings

Ambient temperature	$T_A$	- 45/+ 85	°C	—
Storage temperature	$T_{stg}$	- 45/+ 85	°C	—
DC voltage	$V_{DC}$	5	V	—
Source power	$P_s$	0	dBm	source impedance 50 $\Omega$

**Characteristics**

Ambient temperature	$T_A = 25\text{ °C}$
Source impedance	$Z_S = 50\ \Omega$
Load impedance	$Z_L = 50\ \Omega$
Group delay aperture	300 kHz

		min.	typ.	max.	
<b>Center frequency</b> (center between 3 dB points)	$f_c$	155,489	155,520	155,551	MHz
<b>Insertion attenuation at <math>f_c</math></b>	$\alpha_c$	16,0	17,0	18,5	dB
<b>Pass bandwidth</b> $\alpha_{rel} \leq 3\text{ dB}$	$B_{3dB}$	580	610	640	kHz
<b>Phase at 155,52 MHz</b>	$\varphi_N$	—	70	—	°
<b>Relative attenuation</b> (relative to $\alpha_c$ ) First sidelobes	$\alpha_{rel}$	23	25	—	dB
<b>Group delay at <math>f_c</math></b>	$\tau_c$	1100	1130	1160	ns
<b>Ageing of <math>f_c</math></b>		—	—	+50/-100	ppm
<b>Temperature coefficient of frequency</b>	$TC_f$	—	- 0,03	—	ppm/K <sup>2</sup>
<b>Frequency inversion temperature</b>	$T_0$	80	90	100	° C

Temperature dependence of  $f_c$ :  $f_c(T_A) = f_c(T_0) (1 + TC_f (T_A - T_0)^2)$

Phase tolerance  $\Delta\varphi_N$ :  $\Delta\varphi_N = - \Delta f_c \cdot \tau_{c,max} \cdot 360\text{ °}$

**B 5533**  
**155,52 MHz**

**Frequency response**

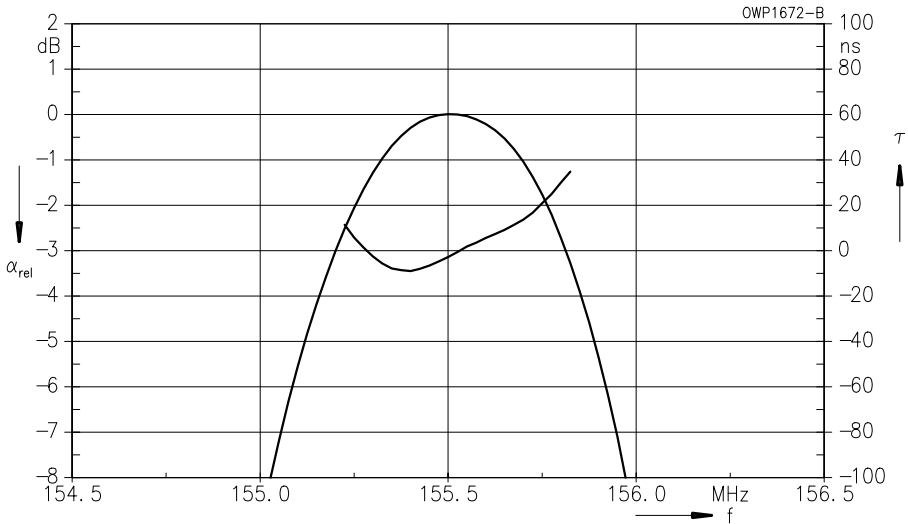
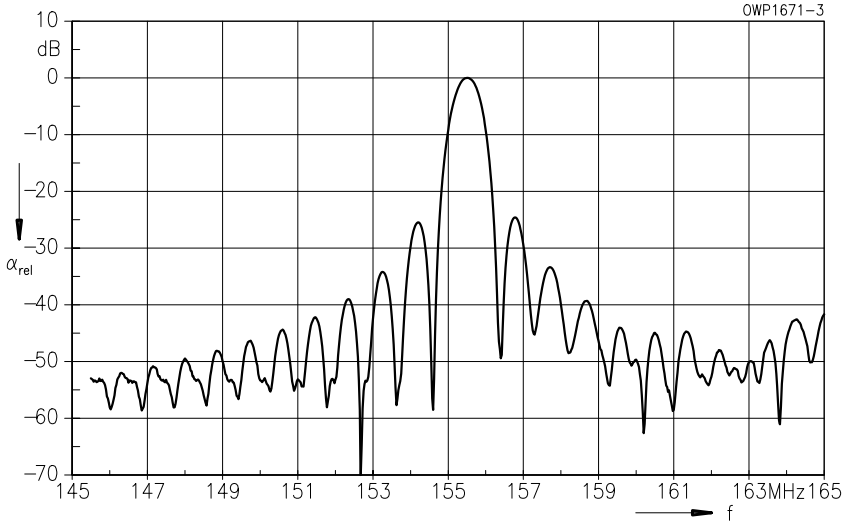



## Features

- Passive or active timing recovery for digital transmission systems
- Hermetically sealed metal package

## Terminals

- Gold-plated NiFeCo alloy

Metal package TO 39

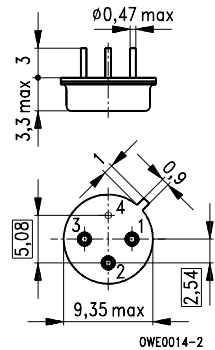

Dimensions in mm, approx. weight 1,0 g

## Pin configuration

- 1 Input
- 2 Not connected
- 3 Output
- 4 Input – ground  
Output – ground  
Case – ground

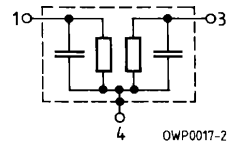

Type	Ordering code	Marking
B 5531	B39621-B5531-B210	Type, date code

Electrostatic Sensitive Device (ESD)

## Maximum ratings

Ambient temperature	$T_A$	- 45/+ 85	°C	—
Storage temperature	$T_{stg}$	- 45/+ 85	°C	—
DC voltage	$V_{DC}$	5	V	—
Source power	$P_s$	0	dBm	source impedance 50 $\Omega$

**B 5531**  
**622,08 MHz**

**Characteristics**

Ambient temperature	$T_A = 25\text{ °C}$
Source impedance	$Z_S = 50\ \Omega$
Load impedance	$Z_L = 50\ \Omega$
Group delay aperture	250 kHz

		min.	typ.	max.	
<b>Center frequency</b> (center between 6 dB points)	$f_c$	621,93	622,08	622,23	MHz
<b>Insertion attenuation at <math>f_c</math></b>	$\alpha_c$	16,5	18,0	19,5	dB
<b>Pass bandwidth</b> $\alpha_{rel} \leq 3\text{ dB}$	$B_{3\text{dB}}$	840	925	1010	kHz
<b>Phase at 622,05 MHz</b>	$\varphi_N$	—	0	—	°
<b>Relative attenuation</b> (relative to $\alpha_c$ ) First sidelobes	$\alpha_{rel}$	22,0	24,0	—	dB
<b>Group delay at <math>f_c</math></b>	$\tau_c$	660	720	780	ns
<b>Ageing of <math>f_c</math></b>		—	—	+50/−100	ppm
<b>Temperature coefficient of frequency</b>	$TC_f$	—	− 0,03	—	ppm/K <sup>2</sup>
<b>Frequency inversion temperature</b>	$T_0$	25	35	45	° C

Temperature dependence of  $f_c$ :  $f_c(T_A) = f_c(T_0) (1 + TC_f(T_A - T_0)^2)$

Phase tolerance  $\Delta\varphi_N$ :  $\Delta\varphi_N = -\Delta f_c \cdot \tau_{c,max} \cdot 360\text{ °}$

Frequency response

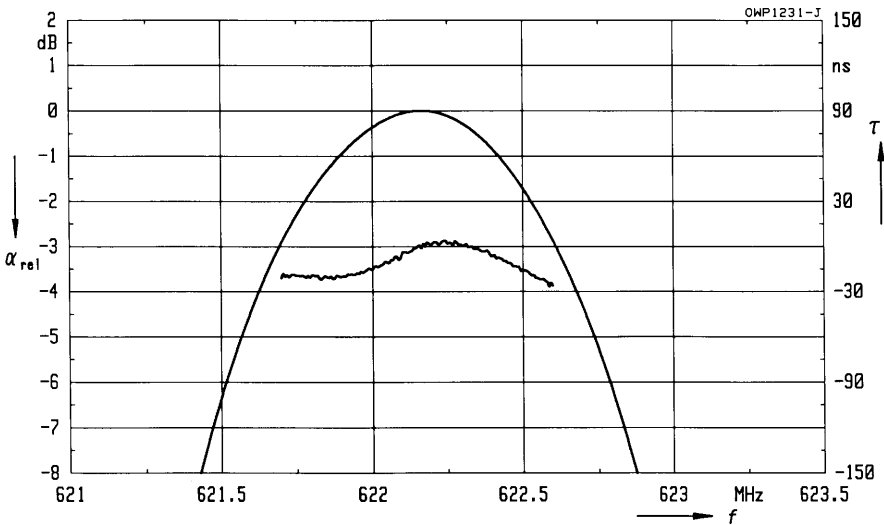
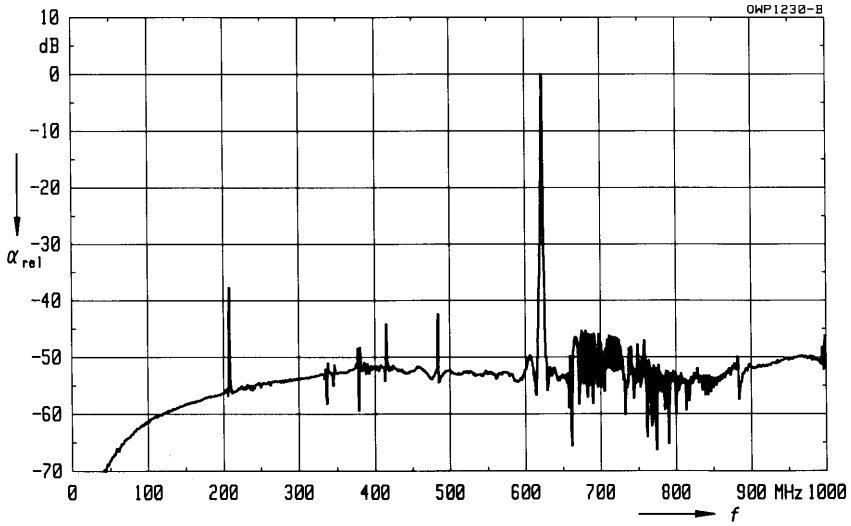



Siemens Matsushita Components

All varistors from SCS stock

# Our number is the right number...

...for varistors right for your application and right to your door.

- ▶ Untaped disks S05 through S20 with rated voltages from 11 to 460 V
- ▶ **New:** taped disks S05 through S14 with rated voltages from 14 to 300 V
- ▶ **New:** SMDs in sizes 0603 through 2220 with rated voltages from 4 to 60 V.

Of course, just ask and you can also have block and strap varistors as well as PowerDisks and energy elements.

**SCS – dependable, fast and competent**









## Resonators



### Survey

Center frequency MHz	Tolerance kHz	Unloaded $Q_U$	Insertion attenuation dB	Package	Type	Page <sup>1)</sup>
-------------------------	------------------	----------------	--------------------------------	---------	------	--------------------

#### 1-port resonators

314,50	75	12300	2,0	TO 39	R 660	#
	100	15000	1,5	QCC 8 	R 706	#
315,00	75	12300	2,0	TO 39	R 639	#
	85	15000	1,5	QCC 8 	R 705	#
417,50	100	9000	1,4	QCC 8 	R 704	#
418,00	75	10500	1,8	TO39	R 643	#
	75	9000	1,4	QCC 8 	R 703	<a href="#">334</a>
423,22	75	11000	1,8	TO 39	R 644	#
433,42	75	10500	1,8	TO 39	R 647	#
	75	8200	1,6	QCC 8 	R 702	#
433,92	75	10500	1,7	TO 39	R 641	<a href="#">336</a>
	75	8200	1,7	QCC 8 	R 701	#

#### 2-port resonators

213,80	64	10000	9,1	TO 39	R 2637	#
224,50	67	9300	8,5	TO 39	R 2523	#
304,35	75	8400	7,3	TO 39	R 2653	#
315,05	100	7550	5,5	TO 39	R 2622	#
403,55	120	6700	7,5	TO 39	R 2526	#
407,35	100	8800	8,6	TO 39	R 2635	#
414,25	100	6800	7,0	TO 39	R 2620	#
418,00	80	6700	7,5	TO 39	R 2528	#
	75	7200	9,2	QCC 8 	R 2702	<a href="#">338</a>
418,05	100	7400	8,3	TO 39	R 2630	#
423,22	75	6800	7,3	TO 39	R 2531	#
433,92	75	7200	7,8	TO 39	R 2632	<a href="#">340</a>
	75	7800	9,2	QCC 8 	R 2701	#
849,25	300	4900	11,0	TO 39	R 2533	#

#### Frontend filters for remote control

314,00	150	700	2,5	TO 39	B 3532	#
315,00	150	700	2,5	TO 39	B 3531	#
403,55	150	950	2,5	TO 39	B 3533	#
433,92	150	950	2,3	TO 39	B 3530	<a href="#">343</a>

1) Types marked by the sign # are only listed in the survey. Detailed information upon request.



**Features**

- 1-port resonator
- Hermetically sealed ceramic SMD package

**Terminals**

- Gold-plated Ni

Ceramic package QCC 8

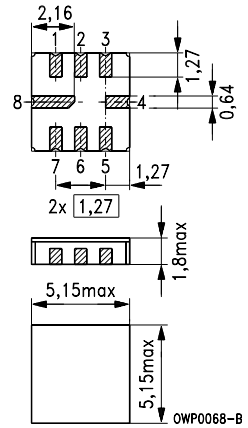

Dimensions in mm, approx. weight 0,13 g

**Pin configuration**

- 2 Input 1
- 6 Ground
- 4, 8 Ground (case)

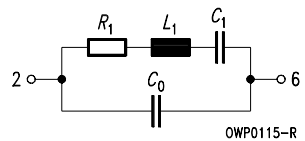

Type	Ordering code	Marking
R 703	B39421-R703-Z010	Type, date code

Electrostatic Sensitive Device (ESD)

**Maximum ratings**

Ambient temperature	$T_A$	- 45/+ 85	°C	—
Storage temperature	$T_{stg}$	- 45/+ 85	°C	—
DC voltage	$V_{DC}$	12	V	between any terminals
AC voltage	$V_{pp}$	12	V	between any terminals
Power dissipation	$P_{max}$	0	dBm	—

**Characteristics**

Ambient temperature	$T_A = 25\text{ °C}$
Source impedance	$Z_S = 50\ \Omega$
Load impedance	$Z_L = 50\ \Omega$

		min.	typ.	max.	
<b>Center frequency</b>	$f_c$	417,925	418,000	418,075	MHz
<b>Minimum insertion attenuation</b>	$\alpha_{\min}$	—	1,4	2,0	dB
Unloaded quality factor	$Q_U$	6000	9000	—	
<b>Ageing of <math>f_c</math></b>		—	—	$\pm 50$	ppm
<b>Equivalent circuit elements</b>					
Motional capacitance	$C_1$	—	2,0	—	fF
Motional inductance	$L_1$	—	72,5	—	$\mu\text{H}$
Motional resistance	$R_1$	—	23,0	—	$\Omega$
Parallel capacitance	$C_0$	—	3,4	—	pF
<b>Temperature coefficient of frequency</b>	$TC_f$	—	- 0,03	—	ppm/K <sup>2</sup>
Frequency inversion point	$T_0$	20	—	50	°C

Center frequency is defined as maximum of the real part of the admittance

Temperature dependence of  $f_c$ :  $f_c(T_A) = f_c(T_0)(1 + TC_f(T_A - T_0)^2)$

Features

- 1-port resonator

Metal package TO 39

Terminals

- Gold-plated NiFeCo alloy

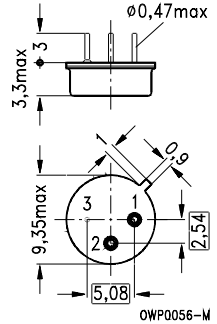

Dimensions in mm, approx. weight 1,0 g

Pin configuration

- 1 Input 1
- 2 Ground
- 3 Ground

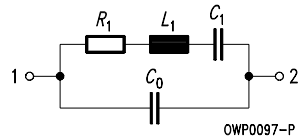

Type	Ordering code	Marking
R 641	B39431-R641-B110	Type, date code

Electrostatic Sensitive Device (ESD)

Maximum ratings

Ambient temperature	$T_A$	- 45/+ 85	°C	—
Storage temperature	$T_{stg}$	- 45/+ 85	°C	—
DC voltage	$V_{DC}$	12	V	between any terminals
AC voltage	$V_{pp}$	12	V	between any terminals
Power dissipation	$P_{max}$	0	dBm	—



**Characteristics**

Ambient temperature  $T_A = 25\text{ °C}$   
 Source impedance  $Z_S = 50\ \Omega$   
 Load impedance  $Z_L = 50\ \Omega$

		min.	typ.	max.	
<b>Center frequency</b>	$f_c$	433,845	433,920	433,995	MHz
<b>Minimum insertion attenuation</b>	$\alpha_{\min}$	—	1,4	2,4	dB
Unloaded quality factor	$Q_U$	6000	10500	—	
<b>Ageing of <math>f_c</math></b>		—	—	±50	ppm
<b>Equivalent circuit elements</b>					
Motional capacitance	$C_1$	—	1,2	—	fF
Motional inductance	$L_1$	—	112,1	—	μH
Motional resistance	$R_1$	—	26	—	Ω
Parallel capacitance	$C_0$	—	3,6	—	pF
<b>Temperature coefficient of frequency</b>	$TC_f$	—	-0,03	—	ppm/K <sup>2</sup>
Frequency inversion point	$T_0$	20	—	50	°C

Center frequency is defined as maximum of the real part of the admittance

Temperature dependence of  $f_C$ :  $f_C(T_A) = f_C(T_0)(1 + TC_f(T_A - T_0)^2)$



**Features**

- 2-port resonator
- Hermetically sealed SMD package

**Terminals**

- Gold-plated NiFeCo alloy

Ceramic package QCC 8

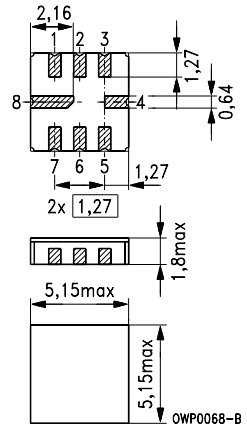

Dimensions in mm, approx. weight 0,13 g

**Pin configuration**

- 2 Input
- 6 Output
- 7 Ground (input)
- 3 Ground (output)

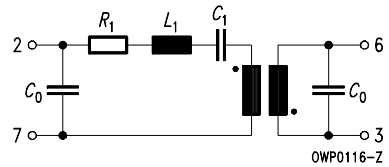

Type	Ordering code	Marking
R 2702	B39421-R2702-Z010	Type, date code

Electrostatic Sensitive Device (ESD)

**Maximum ratings**

Ambient temperature	$T_A$	- 45/+ 85	°C	—
Storage temperature	$T_{stg}$	- 45/+ 85	°C	—
DC voltage	$V_{DC}$	12	V	between any terminals
AC voltage	$V_{pp}$	12	V	between any terminals
Power dissipation	$P_{max}$	0	dBm	—

**Characteristics**

Ambient temperature  $T_A = 25\text{ °C}$   
 Source impedance  $Z_S = 50\ \Omega$   
 Load impedance  $Z_L = 50\ \Omega$

		min.	typ.	max.	
<b>Center frequency</b> (center between 3 dB points)	$f_c$	417,925	418,000	418,075	MHz
<b>Insertion attenuation at <math>f_c</math></b>	$\alpha$	—	9,2	10,5	dB
Phase at $f_c$	$\varphi$	—	160	—	°el.
Loaded quality factor	$Q_L$	5000	7200	—	
Unloaded quality factor	$Q_U$	8000	10200	—	
<b>Ageing of <math>f_c</math></b>		—	—	$\pm 50$	ppm
<b>Equivalent circuit elements</b>					
Motional capacitance	$C_1$	—	0,15	—	fF
Motional inductance	$L_1$	—	0,943	—	mH
Motional resistance	$R_1$	—	240	—	$\Omega$
Parallel capacitance	$C_0$	—	2,2	—	pF
<b>Temperature coefficient of frequency</b>	$TC_f$	—	- 0,03	—	ppm/K <sup>2</sup>
Frequency inversion point	$T_0$	—	40	—	°C

Center frequency is defined as maximum of the real part of the admittance  
 Temperature dependence of  $f_c$ :  $f_c(T_A) = f_c(T_0)(1 + TC_f(T_A - T_0)^2)$

**Frequency response**

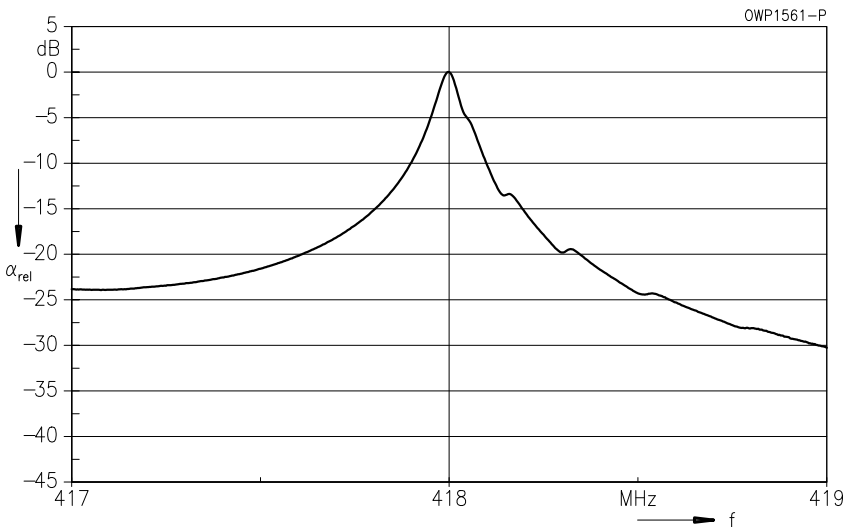

Features

- 2-port resonator

Terminals

- Gold-plated NiFeCo alloy

Metal package TO 39

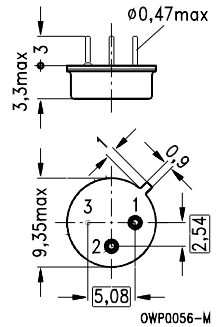

Dimensions in mm, approx. weight 1,0 g

Pin configuration

- 1 Input 1
- 2 Input 2
- 3 Ground

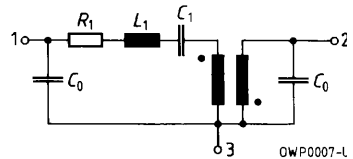

Type	Ordering code	Marking
R 2632	B39431-R2632-B110	Type, date code

Electrostatic Sensitive Device (ESD)

Maximum ratings

Ambient temperature	$T_A$	- 45/+ 85	°C	—
Storage temperature	$T_{stg}$	- 45/+ 85	°C	—
DC voltage	$V_{DC}$	12	V	between any terminals
AC voltage	$V_{pp}$	12	V	between any terminals
Power dissipation	$P_{max}$	0	dBm	—

**Characteristics**

Ambient temperature  $T_A = 25\text{ }^\circ\text{C}$   
 Source impedance  $Z_S = 50\ \Omega$   
 Load impedance  $Z_L = 50\ \Omega$

		min.	typ.	max.	
<b>Center frequency</b> (center between 3 dB points)	$f_c$	433,845	433,920	433,995	MHz
<b>Insertion attenuation at <math>f_c</math></b>	$\alpha$	—	7,8	9,5	dB
Phase at $f_c$	$\varphi$	—	160	—	$^\circ\text{el.}$
Loaded quality factor	$Q_L$	5000	7200	—	
Unloaded quality factor	$Q_U$	9000	12200	—	
<b>Ageing of <math>f_c</math></b>		—	—	$\pm 50$	ppm
<b>Equivalent circuit elements</b>					
Motional capacitance	$C_1$	—	0,20	—	fF
Motional inductance	$L_1$	—	0,67	—	mH
Motional resistance	$R_1$	—	145	—	$\Omega$
Parallel capacitance	$C_0$	1,4	1,8	2,0	pF
<b>Temperature coefficient of frequency</b>	$TC_f$	—	- 0,03	—	ppm/K <sup>2</sup>
Frequency inversion point	$T_0$	35	40	45	$^\circ\text{C}$

Center frequency is defined as maximum of the real part of the admittance

Temperature dependence of  $f_c$ :  $f_c(T_A) = f_c(T_0)(1 + TC_f(T_A - T_0)^2)$

**Note**

For use as 1-port resonator connect pin 1 and pin 2:

**Pin configuration**

- 1,2 Input
- 3 Ground

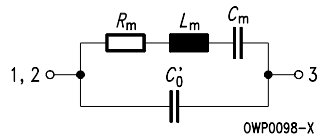

The equivalent circuit elements are calculated as follows:

$$R_m = R_1/4 \quad L_m = L_1/4 \quad C_m = 4 \cdot C_1 \quad C_0' = 2 \cdot C_0$$

Frequency response

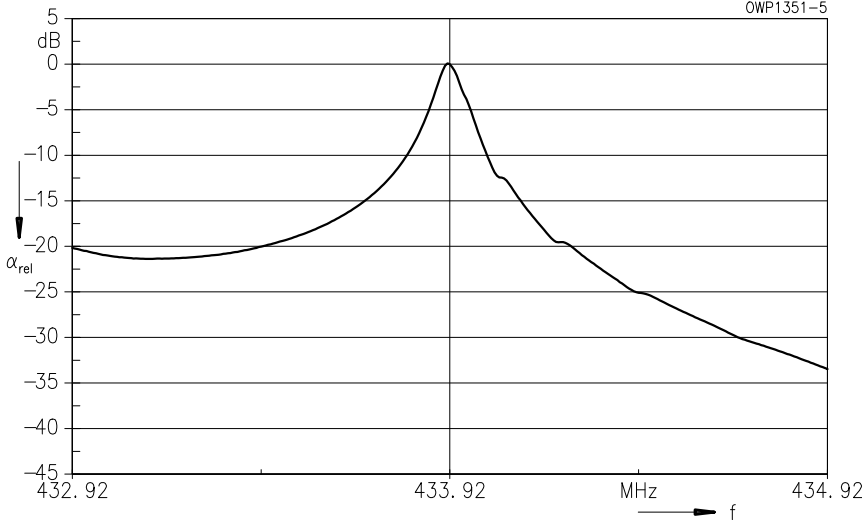

## Features

- Resonator filter for remote control receivers

Metal package TO 39

## Terminals

- Gold-plated NiFeCo alloy

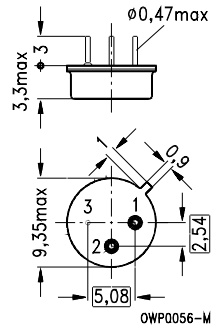

Dimensions in mm, approx. weight 1,0 g

## Pin configuration

- 1 Input
- 2 Output
- 3 Ground

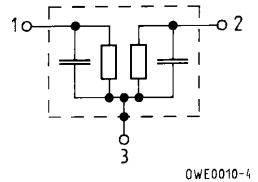

QWE0010-4

Type	Ordering code	Marking
B 3530	B39431-B3530-B110	Type, date code

Electrostatic Sensitive Device (ESD)

## Maximum ratings

Ambient temperature	$T_A$	- 45/+ 85	°C	—
Storage temperature	$T_{stg}$	- 45/+ 85	°C	—
DC voltage	$V_{DC}$	0	V	between any terminals
AC voltage	$V_{pp}$	12	V	between any terminals
Power dissipation	$P_{max}$	0	dBm	—

# B 3530

## 433,92 MHz

### Characteristics

Ambient temperature  
 Source impedance  
 Load impedance

$T_A = 25\text{ °C}$   
 $Z_S = 50\ \Omega$  and matching network  
 $Z_L = 50\ \Omega$  and matching network

		min.	typ.	max.	
<b>Center frequency</b> (center between 3 dB points)	$f_c$	433,770	433,920	434,070	MHz
<b>Insertion attenuation at <math>f_c</math></b>	$\alpha$	—	2,3	4,0	dB
<b>Pass bandwidth</b> ( $\alpha_{rel} \leq 3\text{ dB}$ )	$B_{3dB}$	880	950	1000	kHz
<b>Relative attenuation</b>	$\alpha_{rel}$				
10,00 ... 300,00 MHz		45	60	—	dB
300,00 ... 426,00 MHz		40	50	—	dB
444,00 ... 550,00 MHz		40	50	—	dB
550,00 ... 1000,00 MHz		45	60	—	dB
<b>Ageing of <math>f_c</math></b>		—	—	$\pm 50$	ppm
<b>Temperature coefficient of frequency</b> <sup>1)</sup>	$TC_f$	—	-0,03	—	ppm/K <sup>2</sup>
Frequency inversion point	$T_0$	—	30	—	°C

Temperature dependence of  $f_c$ :  $f_c(T_A) = f_c(T_0)(1 + TC_f(T_A - T_0)^2)$

### Matching network:

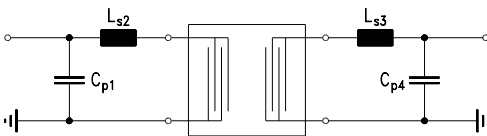

$C_{p1} = 8,2\text{ pF}$   
 $L_{s2} = 62\text{ nH}$   
 $L_{s3} = 62\text{ nH}$   
 $C_{p4} = 8,2\text{ pF}$

0WP0060-F



Frequency response

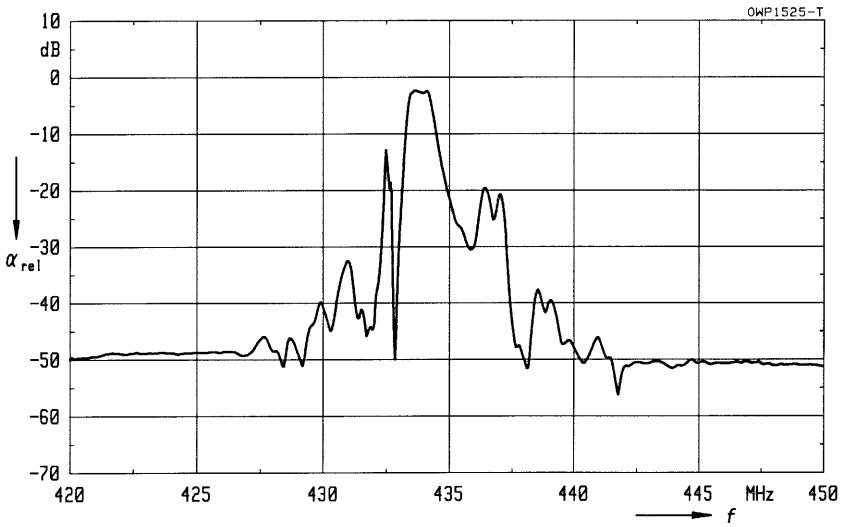



Siemens Matsushita Components

Inductive ferrite components  
from SCS stock

## Transformation at its best

Not just one-off solutions but complete ones designed precisely to a requirements profile are more in demand than ever. So we are offering surface-mount transformers for power and broadband applications straight from SCS stock:

- ▶ **E 6,3** with small dimensions, low leakage inductance and high electric strength
- ▶ **ER 11** flat and with low leakage inductance
- ▶ **RM 4 LP** for high DC biasing
- ▶ **S interface transformer RM 5** for precise pulse transmission in ISDN terminals
- ▶ **U interface transformer RM 6** for ISDN applications

SCS – dependable, fast and competent



## Symbols and Terms

The following symbols and terms are used in the data sheets and in the chapter "General Technical Information":

<b>Symbols Symbole</b>	<b>English English</b>	<b>German Deutsch</b>
$a$	Roll-off factor	Roll-off-Faktor
$B_{\text{dB}}$	Pass bandwidth ( $\alpha_{\text{rel}} \leq x$ dB)	Durchlaßbandbreite ( $\alpha_{\text{rel}} \leq x$ dB)
$C$	Capacitance	Kapazität
$C_0$	Parallel capacitance	Parallelkapazität
$C_1$	Motional capacitance	Dynamische Kapazität
$C_{\text{IN}}$	Input capacitance	Eingangskapazität
$C_{\text{OUT}}$	Output capacitance	Ausgangskapazität
ESD	<b>Electrostatic Sensitive Device</b>	Elektrostatisch gefährdetes Bauelement
$f$	Frequency	Frequenz
$f_c$	Center frequency	Mittenfrequenz
$f_N$	Nominal frequency	Nennfrequenz
$f_Y$	Nyquist frequency	Nyquistfrequenz
$k$	$\sin x/x$ compensation factor	$\sin x/x$ Kompensationsfaktor
$L$	Inductance	Induktivität
$L_1$	Motional inductance	Dynamische Induktivität
$P_{\text{max}}$	Power dissipation	Verlustleistung
$P_{\text{IN}}$	Input power	Eingangsleistung
$P_S$	Source power (source impedance 50 $\Omega$ )	Generatorleistung (Quellimpedanz 50 $\Omega$ )
$p$	Partitioning factor	Aufteilungsfaktor
$Q$	Quality factor	Güte
$Q_L$	Loaded quality factor	Betriebsgüte
$Q_U$	Unloaded quality factor	Leerlaufgüte
$R$	Resistance	Widerstand
$R_1$	Motional resistance	Resonanzwiderstand
$R_{\text{IN}}$	Input resistance	Eingangswiderstand
$R_{\text{OUT}}$	Output resistance	Ausgangswiderstand
$T_0$	Frequency inversion temperature	Frequenzumkehrtemperatur
$T_A$	Ambient temperature	Umgebungstemperatur
$T_{\text{stg}}$	Storage temperature	Lagertemperatur
$TC_f$	Temperature coefficient of frequency	Temperaturkoeffizient der Frequenz
$t$	Time	Zeit
$V_{\text{DC}}$	DC voltage	Gleichspannung

## Symbols and Terms

<b>Symbols Symbole</b>	<b>English English</b>	<b>German Deutsch</b>
$V_{pp}$	AC voltage (p-p)	Wechselspannung (Spitze-Spitze)
$Z_{IN}$	Input impedance	Eingangsimpedanz
$Z_L$	Load impedance	Lastimpedanz
$Z_{OUT}$	Output impedance	Ausgangsimpedanz
$Z_S$	Source impedance	Quellimpedanz
$\alpha$	Insertion attenuation	Einfügedämpfung
$\alpha_{avg}$	Average insertion attenuation	Durchschnittliche Einfügedämpfung
$\alpha_c$	Insertion attenuation at $f_c$	Einfügedämpfung bei $f_c$
$\alpha_{max}$	Maximum insertion attenuation	Maximale Einfügedämpfung
$\alpha_{min}$	Minimum insertion attenuation	Minimale Einfügedämpfung
$\alpha_N$	Insertion attenuation at $f_N$	Einfügedämpfung bei $f_N$
$\alpha_{rel}$	Relative attenuation	Relative Dämpfung
$\Delta\alpha$	Amplitude ripple (p-p)	Amplitudenwelligkeit (Spitze-Spitze)
$\tau$	Group delay	Gruppenlaufzeit
$\tau_c$	Group delay at $f_c$	Gruppenlaufzeit bei $f_c$
$\tau_N$	Group delay at $f_N$	Gruppenlaufzeit bei $f_N$
$\Delta\tau$	Group delay ripple (p-p) Group delay predistortion	Gruppenlaufzeitwelligkeit (Spitze-Spitze) Gruppenlaufzeitverzerrung
$\varphi_c$	Phase at $f_c$	Phase bei $f_c$
$\varphi_N$	Phase at $f_N$	Phase bei $f_N$
$\Delta\varphi$	Deviation from linear phase	Abweichung von der linearen Phase (Spitze-Spitze)
	Ageing of $f_c$	Alterung von $f_c$
	Frequency response	Frequenzgang
	Frequency response with recommended matching network	Frequenzgang mit empfohlener Anpaßschaltung
	Group delay aperture	Gruppenlaufzeitapertur
	Pass band tilt	Durchlaßbereich-Schräglage
	Feedthrough signal suppression	Unterdrückung des Übersprechens
	Reflected wave signal suppression	Unterdrückung nachlaufender Signale

Commas used in numerical values denote decimal points.

Abbreviation	Range of validity / Full text
B	Australia
B/G	CCIR, Germany, Europe
D/K	OIRT, eastern standard, China
L/L'	France
I	Great Britain
M	Japan
M/N	FCC, USA, South America
DAB	Digital Audio Broadcasting
DCR	Digital Cable Radio
DSS	Digital Satellite System
AMPS	Mobile telephone, USA (Advanced Mobile Phone System)
CT 1	Cordless telephone, Europe (Cordless Telephone, 1st Generation)
CT 2	Cordless telephone, Europe (Cordless Telephone, 2nd Generation)
CT ISM	Cordless telephone, USA (Cordless Telephone, Industrial, Scientific, Medical)
DECT	Cordless telephone, Europe (Digital European Cordless Telephone)
EGSM	Mobile telephone, Europe (Extended Global System for Mobile Communication)
ETACS	Mobile telephone, Europe, Asia (Extended Total Access Communication System)
GSM	Mobile telephone, Europe (Global System for Mobile Communication)
NTACS	Mobile telephone, Japan (Nippon Total Access Communication System)
PCN	Mobile telephone, Europe (Personal Communication Network)
PCS	Mobile telephone, USA (Personal Communication Services)

# Subject Index

---

## A

- application notes for resonators [42](#)
- oscillation circuits [42](#)
- remote control system [44](#)
- application notes for TV IF filters [40](#)
  - matching and driver stage [40](#)
  - switchable audio filters [41](#)
  - switchable video/intercarrier filters [40](#)

## B

- bandpass filters [303](#)

## C

- characteristics [29](#)
- chip size [28](#)
- clock recovery filters [325](#)
- construction [27](#)

## E

- echo signals [29](#)

## F

- feedthrough signals [29](#)
- filter design [28](#)
- filter impedances [30](#)
- frequency domain [29](#)
- frequency response [30](#)

## G

- group delay [30](#)

## I

- IF filters for audio applications [217](#)
- IF filters for intercarrier applications [47](#)
- IF filters for quasi/split sound applications [115](#)
- IF filters for video applications [181](#)
- input transducer [27](#)

## O

- operating principles [27](#)
- output transducer [27](#)

## P

- phase velocity [28](#)
- pulse response [29](#)

## R

- reflections [29](#)
- resonators [333](#)

## S

- satellite filters [247](#)
- spectrum-shaping filters [293](#)
- spurious signals [29](#)
- step signal [39](#)

## T

- temperature coefficient of frequency [33](#)
- testing [33](#)
  - final measurements [33](#)
  - insertion attenuation [33](#)
  - pulse response [35](#)
  - relative attenuation [35](#)
  - scatter [35](#)
  - test circuits [36](#)
  - test set-up [36](#)
  - TV test signals [38](#)
- time domain [29](#)
- transducer [27](#)
- triple-transit echo [29](#)
- TTE [29](#)

## V

- vestigial sideband filters [273](#)

## Numerics

- 2T signal [38](#)