

GLASS PASSIVATED SUPER FAST RECTIFIER

VOLTAGE RANGE 50 to 600 Volts CURRENT 10 Amperes

FEATURES

- * Low Profile Design for Smart Phone Charger
- * Ideal for SMT Mounting
- * High Forward Surge Capability
- * Low Forward Voltage Drop
- * Excellent High Temperature Stability

MECHANICAL DATA

- * Epoxy: Device has UL flammability classification 94V-0
- * Mounting position: Any

MAXIMUM RATINGS AND ELECTRICAL CHARACTERISTICS

Ratings at 25 °C ambient temperature unless otherwise specified.
Single phase, half wave, 60 Hz, resistive or inductive load.
For capacitive load, derate current by 20%.



ITO-220AC

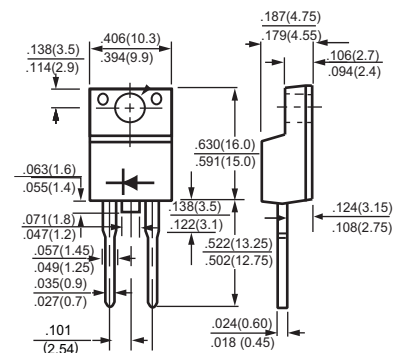

MAXIMUM RATINGS (@ TA=25 °C unless otherwise noted)

RATINGS	SYMBOL	ISF101	ISF102	ISF103	ISF104	ISF105	ISF106	ISF107	UNITS
Maximum Recurrent Peak Reverse Voltage	V _{RRM}	50	100	150	200	300	400	600	Volts
Maximum RMS Voltage	V _{RMS}	35	70	105	140	210	280	420	Volts
Maximum DC Blocking Voltage	V _{DC}	50	100	150	200	300	400	600	Volts
Maximum Average Forward Rectified Current at T _C = 100°C	I _O	10							Amps
Peak Forward Surge Current 8.3 ms single half sine-wave superimposed on rated load (JEDEC method)	I _{FSM}	150							Amps
Typical Current Squared Time	I ² t	93.38							A ² Sec
Typical Thermal Resistance (Note 1)	R _{θJC}	2							°C/W
Typical Junction Capacitance (Note 2)	C _J	150							pF
Operating and Storage Temperature Range	T _J , T _{STG}	-55 to + 150							°C

ELECTRICAL CHARACTERISTICS (@TA=25 °C unless otherwise noted)

CHARACTERISTICS	SYMBOL	ISF101	ISF102	ISF103	ISF104	ISF105	ISF106	ISF107	UNITS
Maximum Instantaneous Forward Voltage at 10.0A DC	V _F	0.95			1.30		1.70		Volts
Maximum DC Reverse Current at Rated DC Blocking Voltage	@ T _A = 25°C	10							uAmps
	@ T _A = 150°C	1.0							mAmps
Maximum Reverse Recovery Time (Note 3)	t _{rr}	35							nSec

- NOTES : 1. Thermal Resistance : Heat-sink case mounted or if PCB mounted.
2. Measured at 1 MHz and applied reverse voltage of 4.0 volts.
3. Test conditions: I_F = 0.5A, I_R = -0.1A, I_{RR} = -0.25A.
4. * ROHS compliant*

RATING AND CHARACTERISTICS CURVES (ISF101 THRU ISF107)

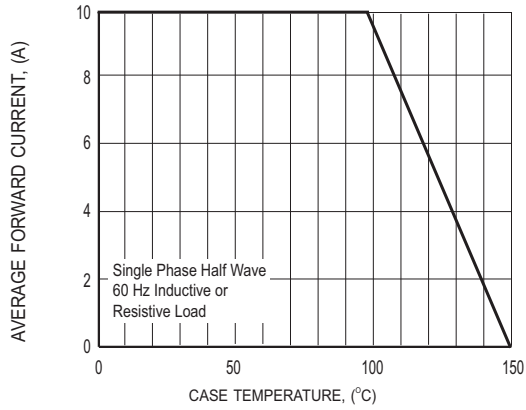

FIG.1 TYPICAL FORWARD CURRENT DERATING CURVE

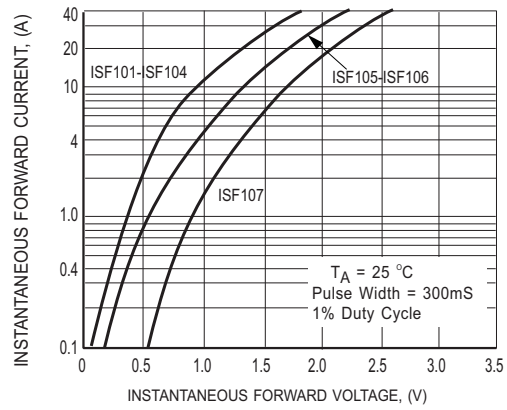

FIG.2 MAXIMUM INSTANTANEOUS FORWARD CHARACTERISTICS

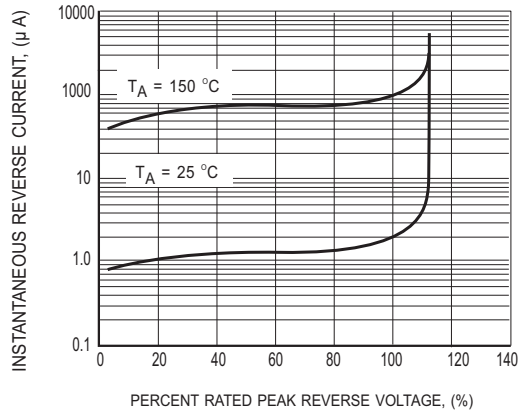

FIG.3 MAXIMUM REVERSE CHARACTERISTICS

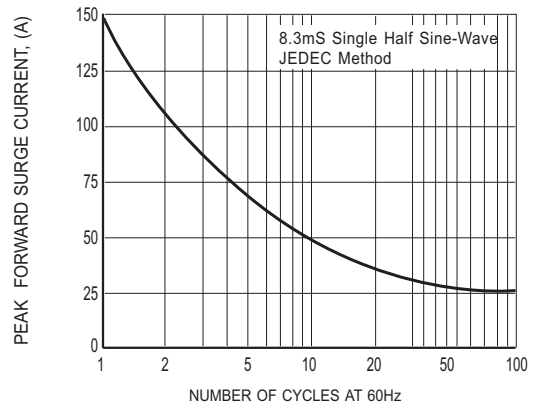
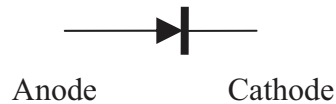

FIG.4 MAXIMUM NON-REPETITIVE FORWARD SURGE CURRENT



Attachment information about ISF101 THRU ISF107

1. Internal Circuit



2. Marking on the body

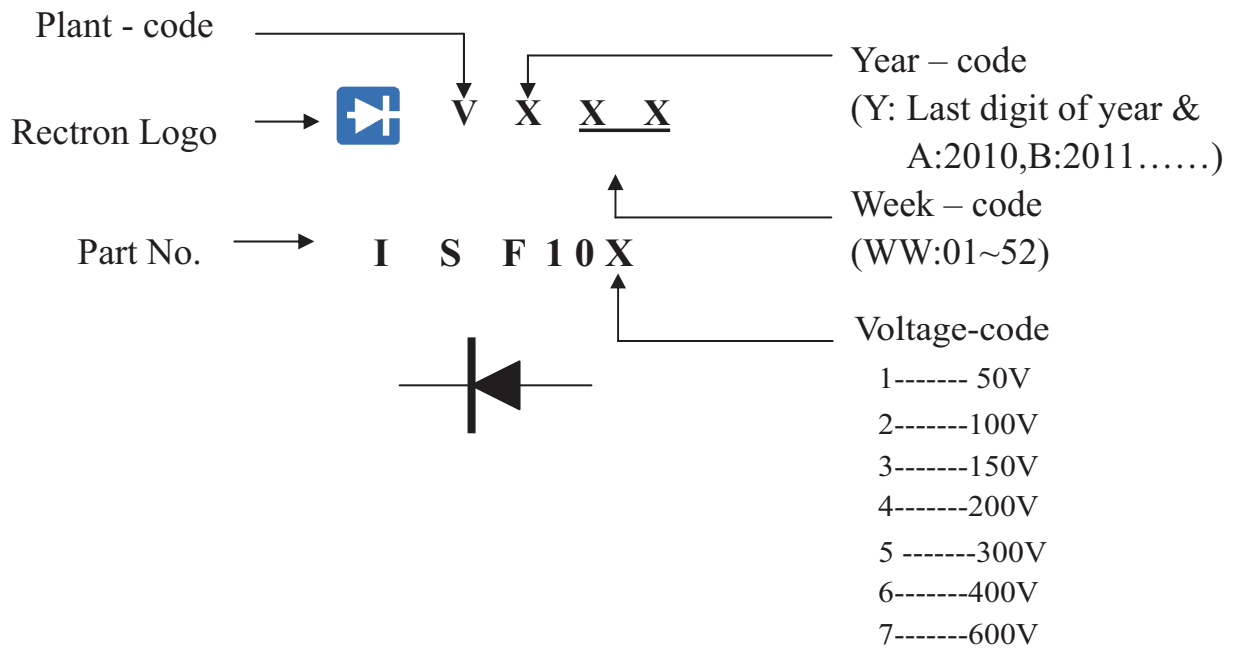

PACKAGING OF DIODE AND BRIDGE RECTIFIERS

TUBE PACK

PACKAGE	PACKING CODE	EA PER BOX	INNER BOX SIZE (mm)	CARTON SIZE (mm)	EA PER CARTON	WEIGHT(Kg)
(I)TO-220/TO-220(A)	-C	2,000	550*140*92	572*308*120	4,000	11.80

DISCLAIMER NOTICE

Rectron Inc reserves the right to make changes without notice to any product specification herein, to make corrections, modifications, enhancements or other changes. Rectron Inc or anyone on its behalf assumes no responsibility or liability for any errors or inaccuracies. Data sheet specifications and its information contained are intended to provide a product description only. "Typical" parameters which may be included on RECTRON data sheets and/ or specifications can and do vary in different applications and actual performance may vary over time. Rectron Inc does not assume any liability arising out of the application or use of any product or circuit.

Rectron products are not designed, intended or authorized for use in medical, life-saving implant or other applications intended for life-sustaining or other related applications where a failure or malfunction of component or circuitry may directly or indirectly cause injury or threaten a life without expressed written approval of Rectron Inc. Customers using or selling Rectron components for use in such applications do so at their own risk and shall agree to fully indemnify Rectron Inc and its subsidiaries harmless against all claims, damages and expenditures.