



# Voltage Regulators

LM100/LM200/LM300

## LM100/LM200/LM300 voltage regulator general description

The LM100, LM200 and LM300 are integrated voltage regulators designed for a wide range of applications from digital power supplies to precision regulators for analog circuitry. Built on a single silicon chip, these devices are encapsulated in either an 8-lead, low profile TO-5 header or a 1/4 x 1/4 metal flat package. Outstanding characteristics are:

- Output voltage adjustable from 2V to 30V (LM300 adjustable from 2V to 20V)
- Better than one percent load and line regulation
- One percent temperature stability
- Adjustable short-circuit limiting
- Output currents in excess of 5A possible by adding external transistors

- Can be used as either a linear or high-efficiency switching regulator.

Additional features are fast response to both load and line transients, small standby power dissipation, freedom from oscillations with varying resistive and reactive loads, and the ability to start reliably on any load within rating.

The LM100 is specified for operation over the  $-55^{\circ}\text{C}$  to  $+125^{\circ}\text{C}$  military temperature range. The LM200 and LM300 are low cost, commercial-industrial versions of the LM100. They are identical to the LM100 except that they are specified for operation from  $-25^{\circ}\text{C}$  to  $85^{\circ}\text{C}$  and from  $0^{\circ}\text{C}$  to  $70^{\circ}\text{C}$  respectively.

## schematic and connection diagrams

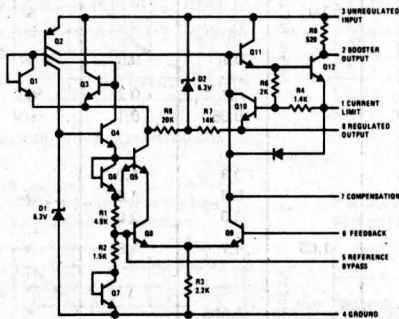

Pin connections shown are for TO-5 package

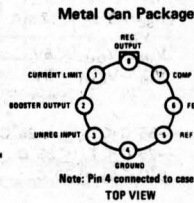

Order Number LM100H  
or LM200H or LM300H  
See Package 11

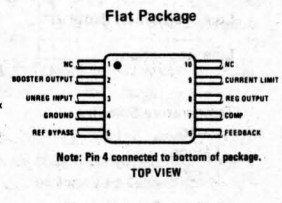

Order Number LM100F  
or LM200F or LM300F  
See Package 3

## typical applications

### Basic Regulator Circuit

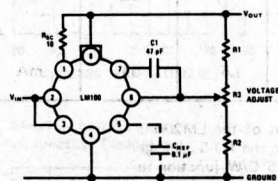

### 200 mA Regulator

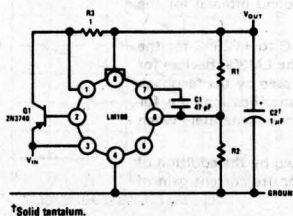

### 2A Regulator With Foldback Current Limiting

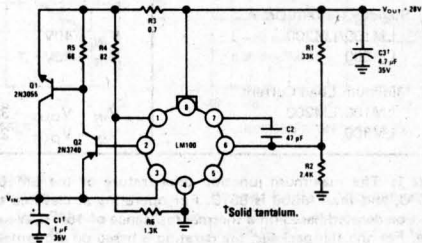

### 4A Switching Regulator

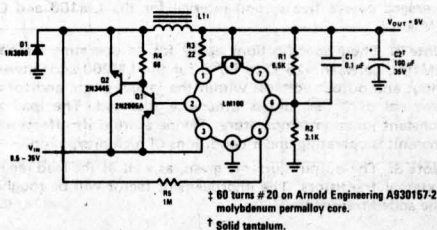

**absolute maximum ratings**

Input Voltage	
LM100, LM200	40V
LM300	35V
Input-Output Voltage Differential	
LM100, LM200	40V
LM300	30V
Power Dissipation (Note 1)	
LM100, LM200	800 mW
LM300	500 mW
Operating Temperature Range	
LM100	-55°C to +125°C
LM200	-25°C to +85°C
LM300	0°C to 70°C
Storage Temperature Range	-65°C to 150°C
Lead Temperature (soldering, 10 sec)	300°C

**electrical characteristics (Note 2)**

PARAMETER	CONDITIONS	MIN	TYP	MAX	UNITS
Input Voltage Range					
LM100/LM200		8.5		40	V
LM300		8.5		30	V
Output Voltage Range					
LM100/LM200		2.0		30	V
LM300				20	V
Output-Input Voltage Differential					
LM100/LM200		3.0		30	V
LM300				20	V
Load Regulation (Note 3)	$R_{SC} = 0, I_O < 12 \text{ mA}$		0.1	0.5	%
Line Regulation	$V_{IN} - V_{OUT} \leq 5\text{V}$		0.1	0.2	%/V
	$V_{IN} - V_{OUT} = 5\text{V}$		0.05	0.1	%/V
Temperature Stability					
LM100	$-55^\circ\text{C} \leq T_A \leq +125^\circ\text{C}$		0.3	1.0	%
LM200	$-25^\circ\text{C} \leq T_A \leq 85^\circ\text{C}$		0.3	1.0	%
LM300	$0^\circ\text{C} \leq T_A \leq 70^\circ\text{C}$		0.3	2.0	%
Feedback Sense Voltage		1.63	1.7	1.81	V
Output Noise Voltage	$10 \text{ Hz} \leq f \leq 10 \text{ kHz}$				
	$C_{REF} = 0$		0.005		%
	$C_{REF} = 0.1 \mu\text{F}$		0.002		%
Long Term Stability			0.1	1.0	%
Standby Current Drain					
LM100/LM200	$V_{IN} = 40\text{V}$		1.0	3.0	mA
LM300	$V_{IN} = 30\text{V}$				
Minimum Load Current					
LM100/LM200	$V_{IN} - V_{OUT} = 30\text{V}$		1.5	3.0	mA
LM300	$V_{IN} - V_{OUT} = 20\text{V}$				

**Note 1:** The maximum junction temperature of the LM100 is 150°C, while that of the LM200 is 100°C, and the LM300 is 85°C. For operating at elevated temperatures, devices in the TO-5 package must be derated based on a thermal resistance of 150°C/W junction to ambient or 45°C/W, junction to case. For the flat package, the derating is based on a thermal resistance of 185°C/W when mounted on a 1/16-inch-thick, epoxy-glass board with ten, 0.03-inch-wide, 2-ounce copper conductors. Peak dissipations to 1.0W are allowable providing the dissipation rating is not exceeded with the power averaged over a five second interval for the LM100 and LM200, and a two second interval for the LM300.

**Note 2:** These specifications apply for an operating temperature between -55°C to +125°C for the LM100, between -25°C to 85°C for the LM200 and between 0°C to 70°C for the LM300 devices for input and output voltages within the ranges given, and for a divider impedance seen by the feedback terminal of 2 kΩ, unless otherwise specified. The load and line regulation specifications are for constant junction temperature. Temperature drift effects must be taken into account separately when the unit is operating under conditions of high dissipation.

**Note 3:** The output currents given, as well as the load regulation, can be increased by the addition of external transistors. The improvement factor will be roughly equal to the composite current gain of the added transistors.

typical performance characteristics

Optimum Divider Resistance Values vs Output Voltage

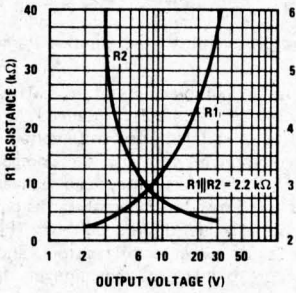

Minimum Input Voltage vs Junction Temperature

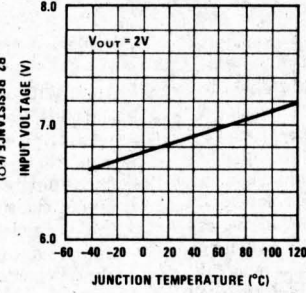

Minimum Load Current vs Input-Output Voltage Differential

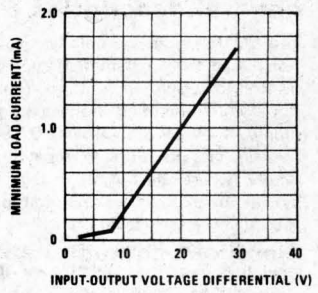

Supply Voltage Rejection vs Input-Output Voltage Differential

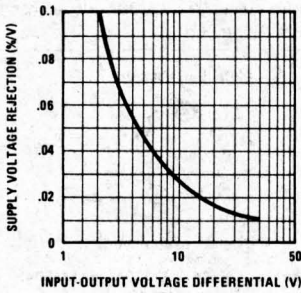

Load Transient Response

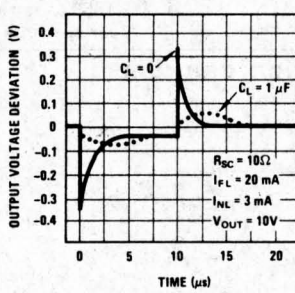

Line Transient Response

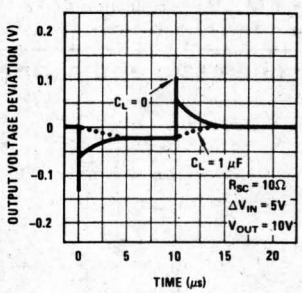

Current Limit Sense Voltage vs Junction Temperature

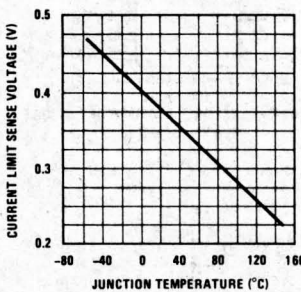

Regulation Characteristics Without Current Limiting

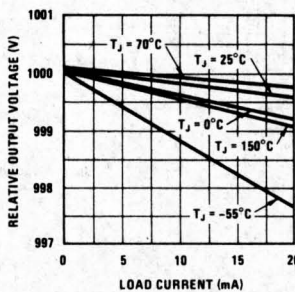

Regulator Dropout Voltage vs Junction Temperature

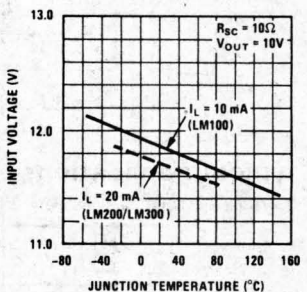

Short Circuit Current vs Junction Temperature

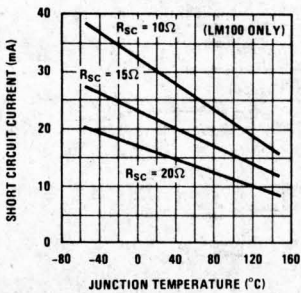

Regulation Characteristics With Current Limiting

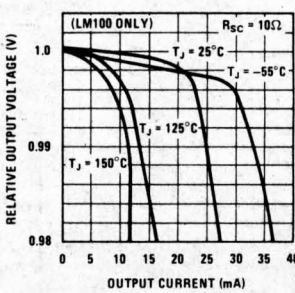

Current Limiting Characteristics

