

# M5216L/P/FP

## DUAL LARGE-CURRENT OPERATIONAL AMPLIFIERS (DUAL POWER SUPPLY TYPE)

### DESCRIPTION

The M5216 is a semiconductor integrated circuit designed as a high-output and high-speed operational amplifier for use in high-performance headphone amplifiers and mixer amplifiers found in cassette decks.

The device comes in an 8-pin SIP, DIP or FP and it contains two circuits for yielding a high internally phase-compensated gain, a high current capacity and a high slew rate. It can be widely used as a general-purpose dual amplifier in electronic equipment. In addition, it can be used in a single power supply format and employed in conditions where the supply voltage is low. These are features which make this device ideal for headphone amplifiers in portable products.

### FEATURES

- Large current capacity .....  $I_{LP} = \pm 100\text{mA}$
- High power output  
 .....  $P_O = 40\text{mW}(\text{typ.}) @ V_{CC} = 6\text{V}, R_L = 32\Omega$   
 .....  $P_O = 27\text{mW}(\text{typ.}) @ V_{CC} = 20\text{V}(\pm 10\text{V})$   
 .....  $R_O + R_L = 100\Omega + 8\Omega$
- High slew rate, high  $f_T$  .....  $SR = 3.0\text{V}/\mu\text{s}, f_T = 10\text{MHz}(\text{typ.})$
- Low noise ( $R_S = 1\text{k}\Omega$ ) FLAT .....  $V_{NI} = 1.8\mu\text{Vrms}(\text{typ.})$
- Low supply voltage drive possible .....  $V_{CC} \geq 4\text{V}(\pm 2\text{V})$
- High allowable power .....  $P_d = 800\text{mW}(\text{SIP})$   
 .....  $P_d = 625\text{mW}(\text{DIP}), P_d = 440\text{mW}(\text{FP})$

### APPLICATION

High-performance headphone amplifiers in VTRs, tape decks and stereo cassette tape recorders with built-in radios; also as a large current high speed, general-purpose operating amplifier in other electronic products and equipment.

### RECOMMENDED OPERATING CONDITION

- Supply voltage range .....  $\pm 2\text{V} \sim \pm 16\text{V}$  (dual power supply)  
 .....  $\pm 4\text{V} \sim \pm 32\text{V}$  (single power supply)
- Rated supply voltage .....  $\pm 15\text{V}$

### PIN CONFIGURATION (TOP VIEW)

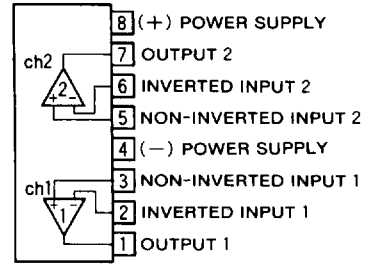

Outline 8P5 (L)

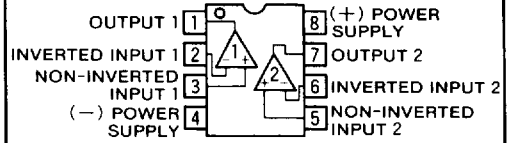

Outline 8P4 (P)  
8P2S-A (FP)

### BLOCK DIAGRAM

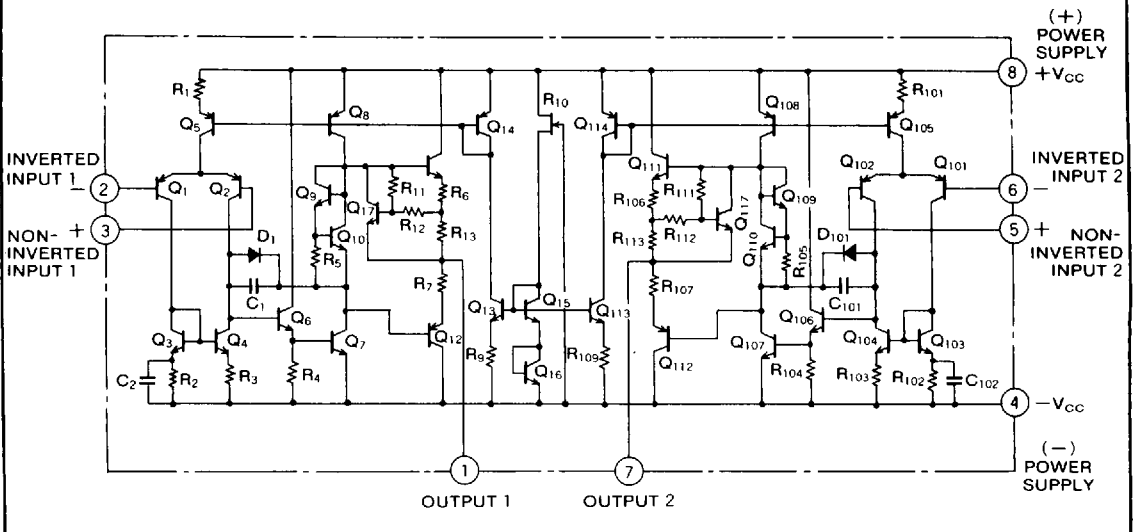

6249826 0021538 T59



**DUAL LARGE-CURRENT OPERATIONAL AMPLIFIERS (DUAL POWER SUPPLY TYPE)**

**ABSOLUTE MAXIMUM RATINGS** ( $T_a=25^\circ\text{C}$ , unless otherwise noted)

Symbol	Parameter	Conditions	Ratings	Unit
$V_{CC}$	Supply voltage		$\pm 18$	V
$I_{LP}$	Load current		$\pm 100$	mA
$V_{id}$	Differential input voltage		$\pm 30$	V
$V_{ic}$	Common input voltage		$\pm 15$	V
$P_d$	Power dissipation		800(SIP)/625(DIP)/440(FP)	mW
$K_\theta$	Thermal derating	$T_a \geq 25^\circ\text{C}$	8(SIP)/6.25(DIP)/4.4(FP)	mW/°C
$T_{opr}$	Ambient temperature		$-20 \sim +75$	°C
$T_{stg}$	Storage temperature		$-55 \sim +125$	°C

**ELECTRICAL CHARACTERISTICS** ( $T_a=25^\circ\text{C}$ ,  $V_{CC}=\pm 15\text{V}$ )

Symbol	Parameter	Test conditions	Limits			Unit
			Min.	Typ.	Max.	
$I_{CC}$	Circuit current	$V_{in}=0$		4.5	9.0	mA
$V_{IO}$	Input offset voltage	$R_S \leq 10\text{k}\Omega$		0.5	6.0	mV
$I_{IO}$	Input offset current			5	200	nA
$I_{IB}$	Input bias current			180	500	nA
$R_{in}$	Input resistance		0.3	5		M $\Omega$
$G_{VO}$	Open loop voltage gain	$R_L \geq 2\text{k}\Omega, V_O = \pm 10\text{V}$	86	110		dB
$V_{OM}$	Maximum output voltage	$R_L \geq 10\text{k}\Omega$ $R_L \geq 2\text{k}\Omega$	$\pm 12$ $\pm 10.5$	$\pm 13.5$ $\pm 11$		V
$V_{CM}$	Common input voltage width		$\pm 12$	$\pm 14$		V
CMRR	Common mode rejection ratio	$R_S \leq 10\text{k}\Omega$	70	90		dB
SVRR	Supply voltage rejection ratio	$R_S \leq 10\text{k}\Omega$		30	150	$\mu\text{V/V}$
$P_d$	Power dissipation			135	270	mW
SR	Slew rate	$G_v=0\text{dB}, R_L=2\text{k}\Omega$		3.0		V/ $\mu\text{s}$
$f_T$	Gain bandwidth product			10		MHz
$V_{NI}$	Input referred noise voltage	$R_S=1\text{k}\Omega, \text{BW}=10\text{Hz} \sim 30\text{kHz}$		1.8		$\mu\text{Vrms}$

**TYPICAL CHARACTERISTICS**

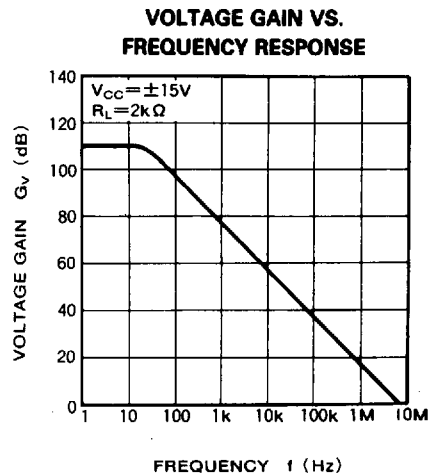
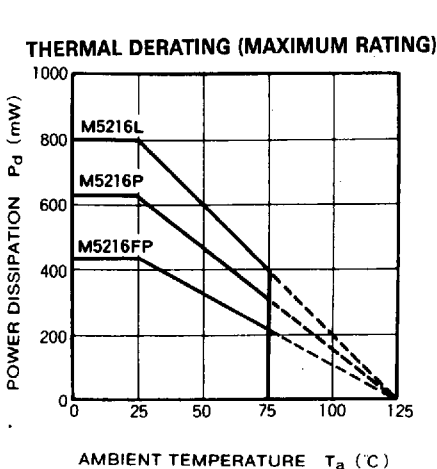

6249826 0021539 995

DUAL LARGE-CURRENT OPERATIONAL AMPLIFIERS (DUAL POWER SUPPLY TYPE)

CIRCUIT CURRENT VS. SUPPLY VOLTAGE

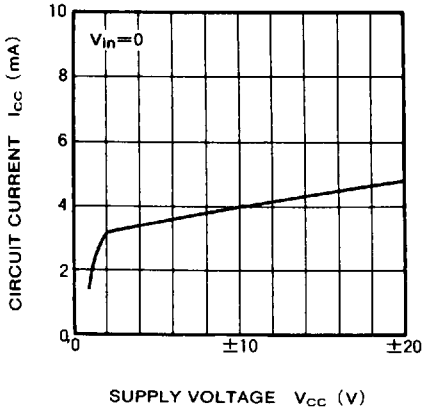

CIRCUIT CURRENT VS. AMBIENT TEMPERATURE

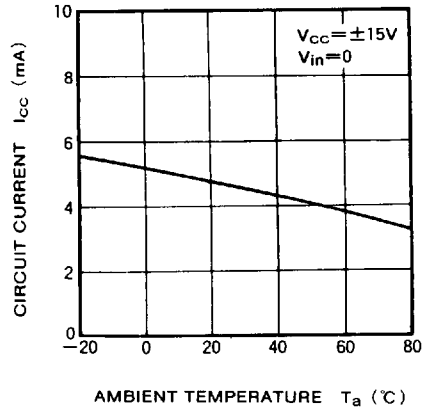

INPUT OFFSET VOLTAGE VS. AMBIENT TEMPERATURE

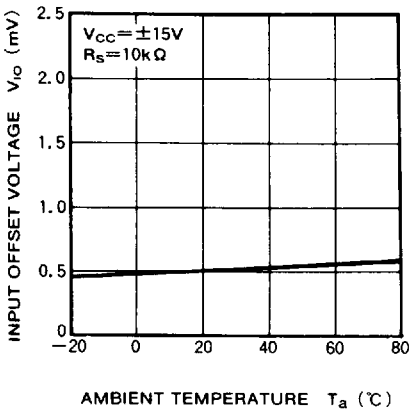

OUTPUT VOLTAGE / LOAD CURRENT PEAK VS. LOAD RESISTANCE

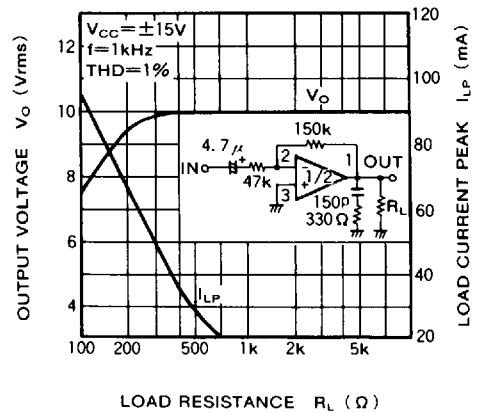

MAXIMUM OUTPUT VOLTAGE VS. SUPPLY VOLTAGE

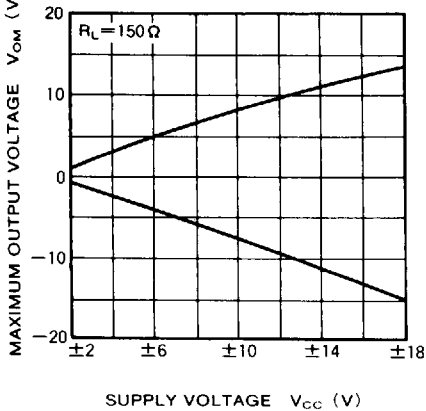

MAXIMUM OUTPUT VOLTAGE VS. FREQUENCY RESPONSE

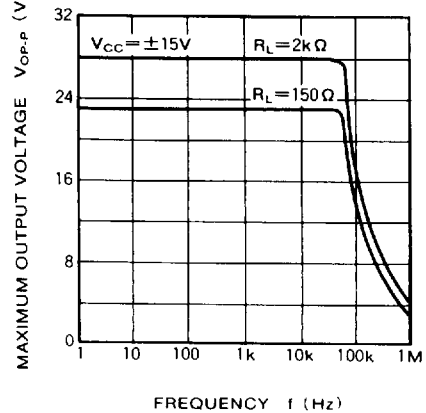

**DUAL LARGE-CURRENT OPERATIONAL AMPLIFIERS (DUAL POWER SUPPLY TYPE)**

**APPLICATION EXAMPLE FOR A HEADPHONE AMPLIFIER (DUAL POWER SUPPLY TYPE)**

**INVERTED INPUT TYPE**

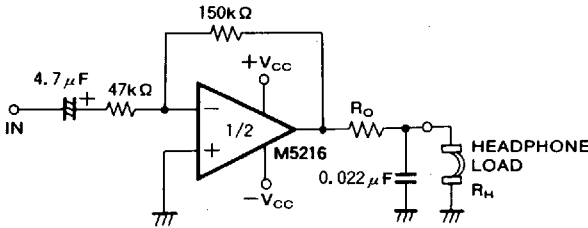

(Note) For a single power supply type, (+) input pin voltage level is shifted at  $V_{CC}/2$  and output must be used by AC connection by means of a capacitor.

**HEADPHONE AMPLIFIER CIRCUIT  $P_o-V_{CC}$  CHARACTERISTICS**

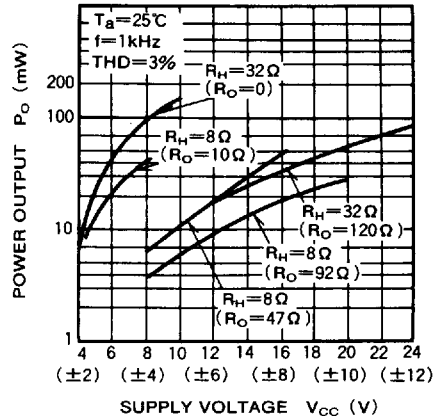

**APPLICATION EXAMPLE FOR A HEADPHONE AMPLIFIER (SINGLE POWER SUPPLY TYPE)**

**NON-INVERTED INPUT TYPE**

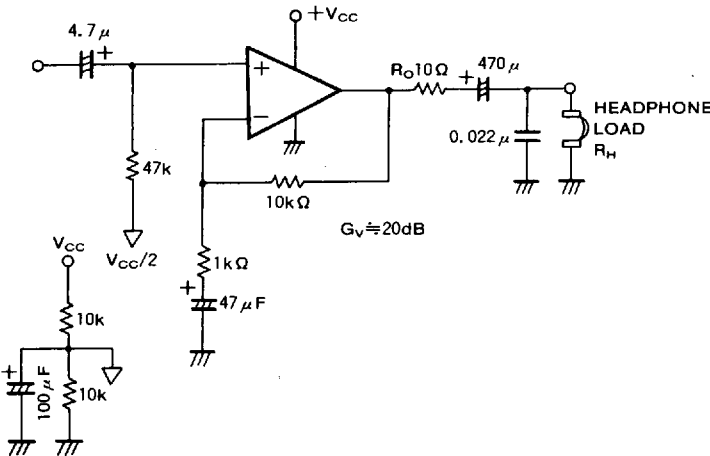

**HEADPHONE AMPLIFIER CIRCUIT THD- $P_o$  CHARACTERISTICS**

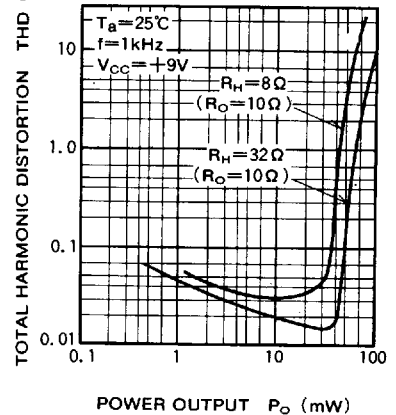

**VOLTAGE GAIN VS. FREQUENCY RESPONSE**

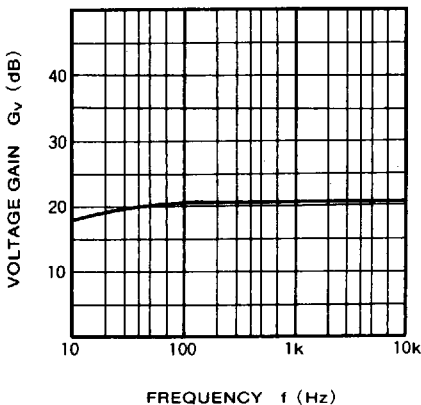

**COUNTERMEASURE AGAINST OSCILLATION**

If oscillation occurs due to load condition, substrate wiring condition, instability of power supply after the M5216 is mounted on the equipment, the following preventative circuit is recommended.

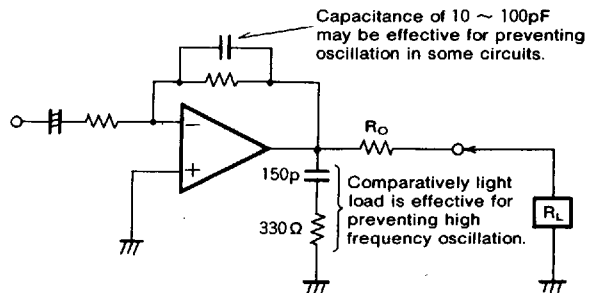

$R_o$  is recommended because it is effective for preventing capacitive load oscillation and controlling current when load is shorted.