

VOLTAGE RANGE: 50 - 1000V
CURRENT: 1.0 A

Features

- Diffused Junction
- Fast Switching for High Efficiency
- High Current Capability and Low Forward Voltage Drop
- Surge Overload Rating to 30A Peak
- Low Reverse Leakage Current

Mechanical Data

- Case: DO-41 Molded Plastic
- Terminals: Plated Leads Solderable per MIL-STD-202, Method 208
- Polarity: Cathode Band
- Marking: Type Number

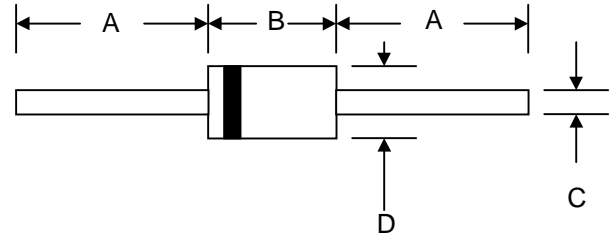
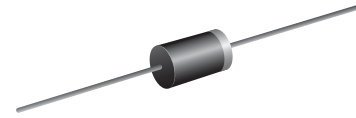

DO-41		
Dim	Min	Max
A	25.4	—
B	4.06	5.21
C	0.71	0.864
D	2.00	2.72
All Dimensions in mm		

Maximum Ratings and Electrical Characteristics @ T_A = 25°C unless otherwise specified

Single phase, half wave, 60Hz, resistive or inductive load. For capacitive load, derate current by 20%

Characteristic	Symbol	PR1001	PR1002	PR1003	PR1004	PR1005	PR1006	PR1007	Unit
Peak Repetitive Reverse Voltage	V _{RRM}	50	100	200	400	600	800	1000	V
Working Peak Reverse Voltage	V _{RWM}								
DC Blocking Voltage (Note 5)	V _R								
RMS Reverse Voltage	V _{R(RMS)}	35	70	140	280	420	560	700	V
Average Rectified Output Current (Note 1)	I _O	1.0							A
@ T _A = 55°C									
Non-Repetitive Peak Forward Surge Current	I _{FSM}	30							A
8.3ms Single half sine-wave Superimposed on Rated Load									
Forward Voltage Drop	V _{FM}	1.3							V
@ I _F = 1.0A									
Peak Reverse Current	I _{RM}	5.0							μA
@ T _A = 25°C									
at Rated DC Blocking Voltage (Note 5)									50
@ T _A = 100°C									
Reverse Recovery Time (Note 3)	t _{rr}	150				250	500		ns
Typical Total Capacitance (Note 2)	C _T	15				8			pF
Typical Thermal Resistance Junction to Ambient	R _{JA}	95							°C/W
Operating and Storage Temperature Range	T _j , T _{STG}	-65 to +150							°C

- Notes:
1. Valid provided that leads are maintained at ambient temperature at a distance of 9.5mm from the case.
 2. Measured at 1.0MHz and applied reverse voltage of 4.0V DC.
 3. Measured with I_F = 0.5A, I_R = 1.0A, I_{rr} = 0.25A. See figure 5.

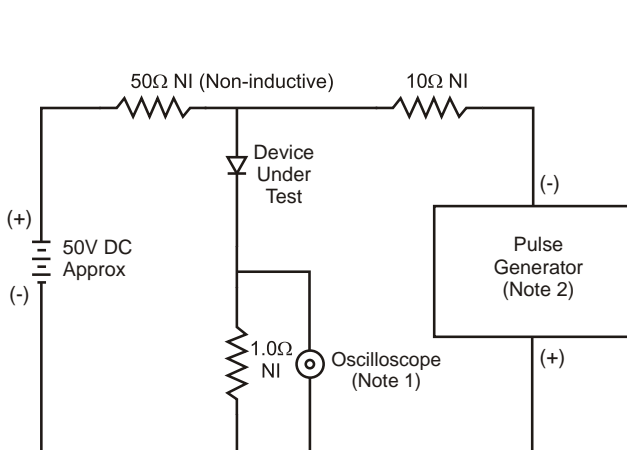
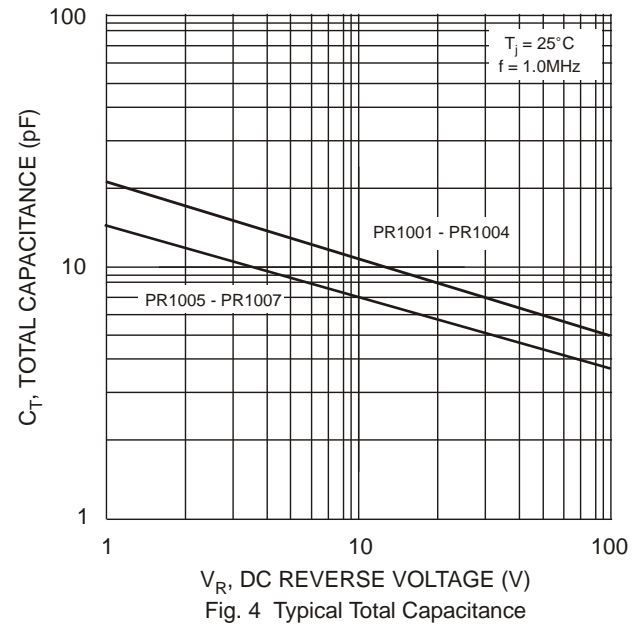
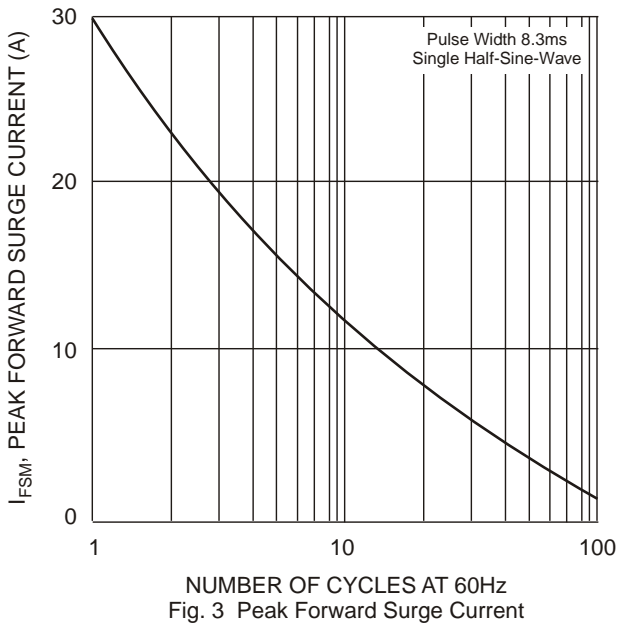
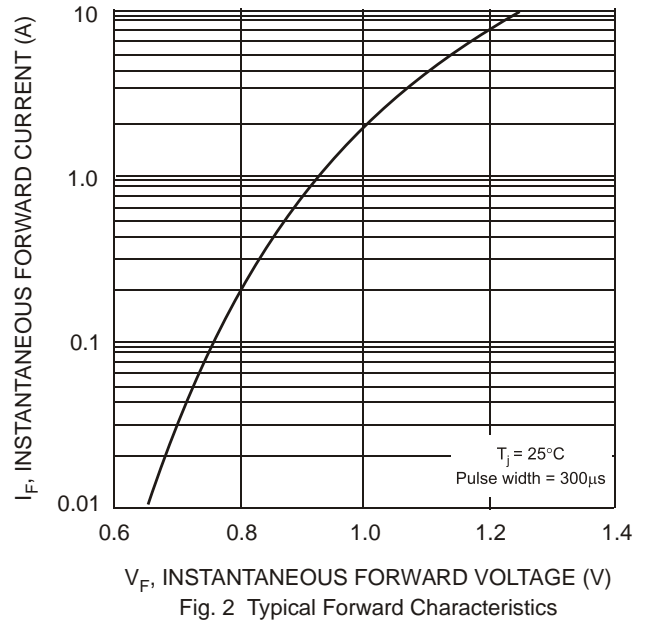
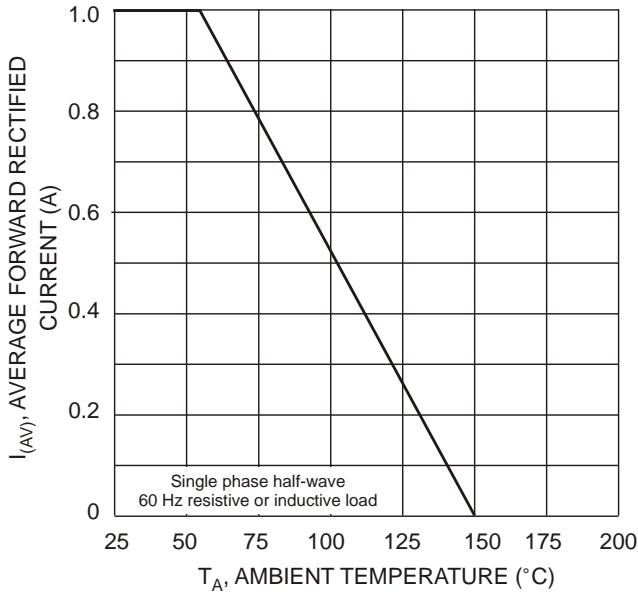

- Notes:
1. Rise Time = 7.0ns max. Input Impedance = 1.0MΩ, 22pF.
 2. Rise Time = 10ns max. Input Impedance = 50Ω.

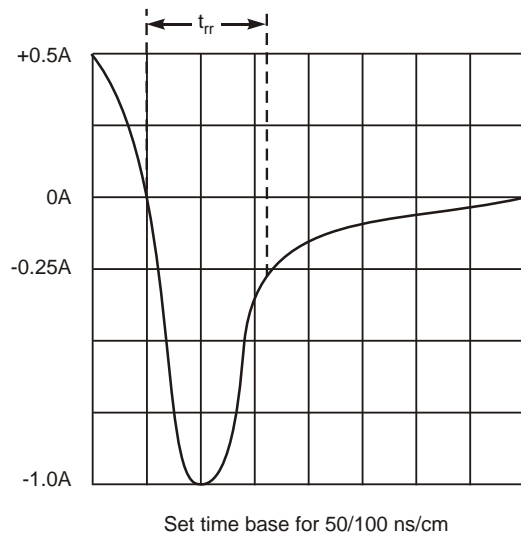

Fig. 5 Reverse Recovery Time Characteristic and Test Circuit