

# DATA SHEET

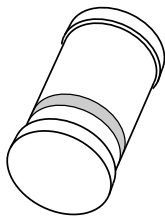

## **PRL5817; PRL5818; PRL5819** Schottky barrier diodes

Product specification  
Supersedes data of November 1993  
File under Discrete Semiconductors, SC01

1996 May 03

# Schottky barrier diodes

# PRLL5817; PRLL5818; PRLL5819

### FEATURES

- Low switching losses
- Fast recovery time
- Guard ring protected
- Hermetically sealed glass SMD package.

### APPLICATIONS

- Low power, switched-mode power supplies
- Rectifying
- Polarity protection.

### DESCRIPTION

The PRLL5817 to PRLL5819 types are Schottky barrier diodes fabricated in planar technology, and encapsulated in SOD87 hermetically sealed glass SMD packages incorporating Implotec<sup>TM</sup>(1) technology.

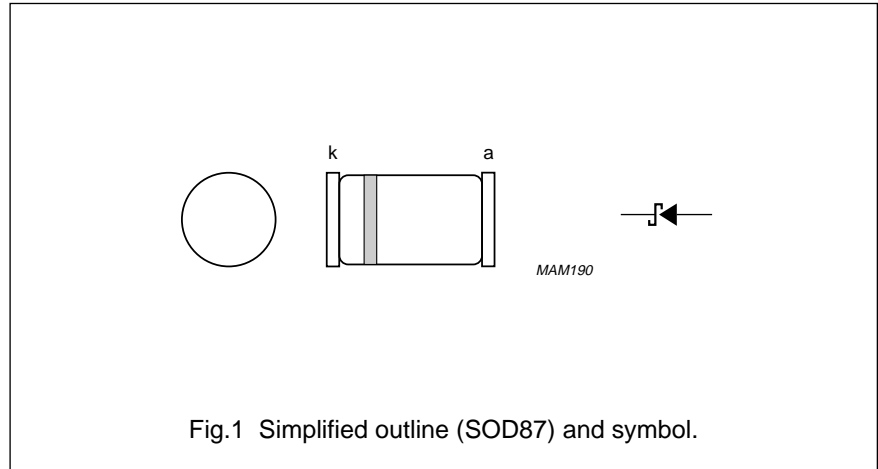

### MARKING

TYPE NUMBER	MARKING CODE
PRLL5817	817 PH
PRLL5818	818 PH
PRLL5819	819 PH

(1) Implotec is a trademark of Philips.

## Schottky barrier diodes

## PRLL5817; PRLL5818; PRLL5819

**LIMITING VALUES**

In accordance with the Absolute Maximum Rating System (IEC 134).

SYMBOL	PARAMETER	CONDITIONS	MIN.	MAX.	UNIT
$V_R$	continuous reverse voltage				
	PRLL5817		–	20	V
	PRLL5818		–	30	V
	PRLL5819		–	40	V
$V_{RSM}$	non-repetitive peak reverse voltage				
	PRLL5817		–	24	V
	PRLL5818		–	36	V
	PRLL5819		–	48	V
$V_{RRM}$	repetitive peak reverse voltage				
	PRLL5817		–	20	V
	PRLL5818		–	30	V
	PRLL5819		–	40	V
$V_{RWM}$	crest working reverse voltage				
	PRLL5817		–	20	V
	PRLL5818		–	30	V
	PRLL5819		–	40	V
$I_{F(AV)}$	average forward current	$T_{amb} = 60\text{ °C}$	–	1	A
$I_{FSM}$	non-repetitive peak forward current	$t = 10\text{ ms}$ half sine wave; $T_j = T_{j\text{ max}}$ prior to surge: $V_R = 0$	–	25	A
$T_{stg}$	storage temperature		–65	+175	°C
$T_j$	junction temperature		–	125	°C

## Schottky barrier diodes

## PRLL5817; PRLL5818; PRLL5819

**ELECTRICAL CHARACTERISTICS**

$T_{amb} = 25\text{ °C}$ ; unless otherwise specified.

SYMBOL	PARAMETER	CONDITIONS	MIN.	TYP.	MAX.	UNIT
$V_F$	forward voltage PRLL5817	see Fig.2 $I_F = 0.1\text{ A}$	–	–	320	mV
		$I_F = 1\text{ A}$	–	–	450	mV
		$I_F = 3\text{ A}$	–	–	750	mV
$V_F$	forward voltage PRLL5818	see Fig.2 $I_F = 0.1\text{ A}$	–	–	330	mV
		$I_F = 1\text{ A}$	–	–	550	mV
		$I_F = 3\text{ A}$	–	–	875	mV
$V_F$	forward voltage PRLL5819	see Fig.2 $I_F = 0.1\text{ A}$	–	–	340	mV
		$I_F = 1\text{ A}$	–	–	600	mV
		$I_F = 3\text{ A}$	–	–	900	mV
$I_R$	reverse current	$V_R = V_{RRMmax}$ ; note 1	–	0.5	1	mA
		$V_R = V_{RRMmax}$ ; $T_j = 100\text{ °C}$	–	5	10	mA
$C_d$	diode capacitance PRLL5817 PRLL5818 PRLL5819	$V_R = 4\text{ V}$ ; $f = 1\text{ MHz}$	–	70	–	pF
			–	50	–	pF
			–	50	–	pF

**Note**

1. Pulsed test:  $t_p = 300\text{ }\mu\text{s}$ ;  $\delta = 0.02$ .

**THERMAL CHARACTERISTICS**

SYMBOL	PARAMETER	CONDITIONS	VALUE	UNIT
$R_{th\ j-a}$	thermal resistance from junction to ambient	note 1	150	K/W

**Note**

1. Refer to SOD87 standard mounting conditions.

Schottky barrier diodes

PRL5817; PRL5818; PRL5819

GRAPHICAL DATA

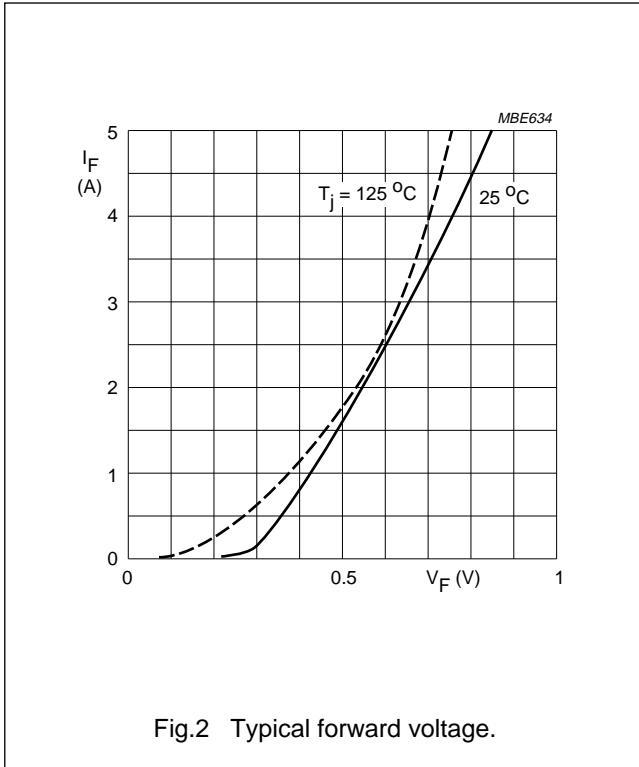

Fig.2 Typical forward voltage.

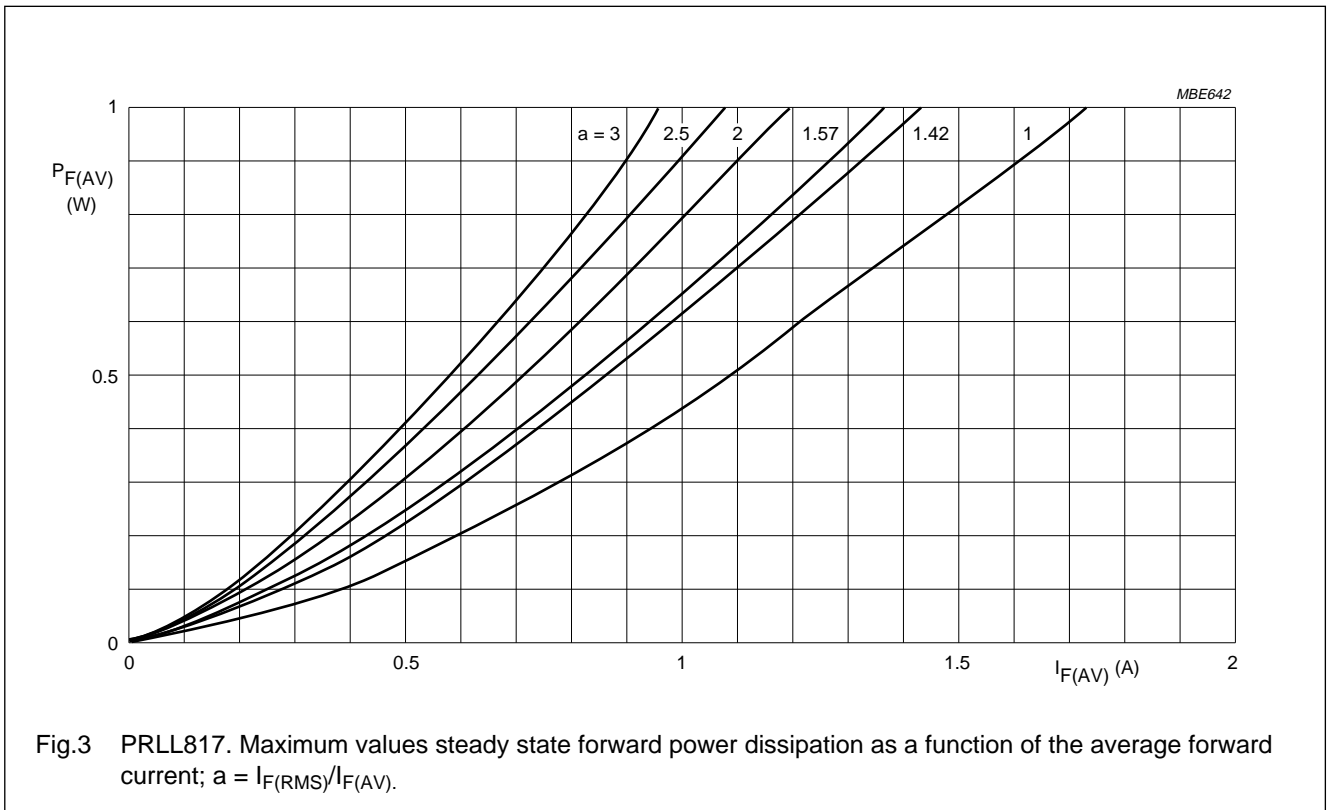
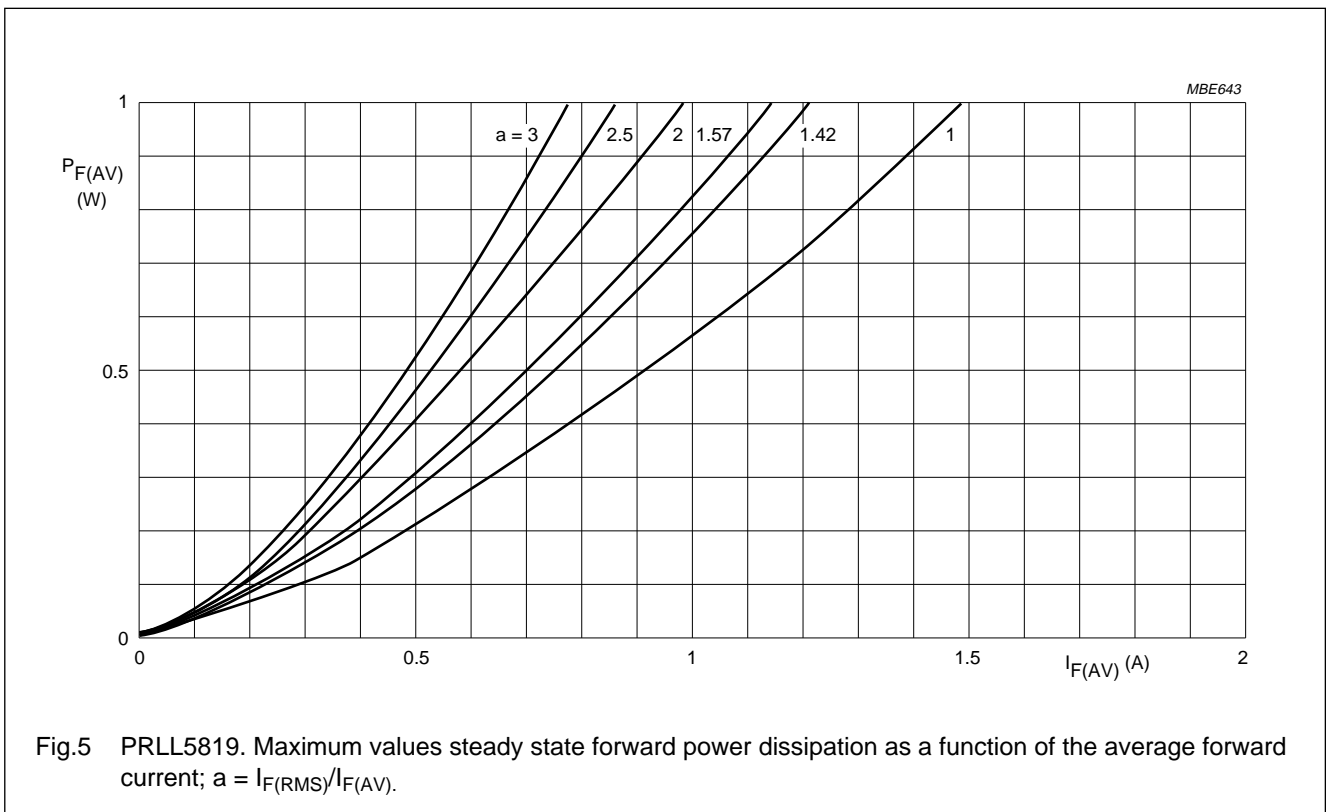
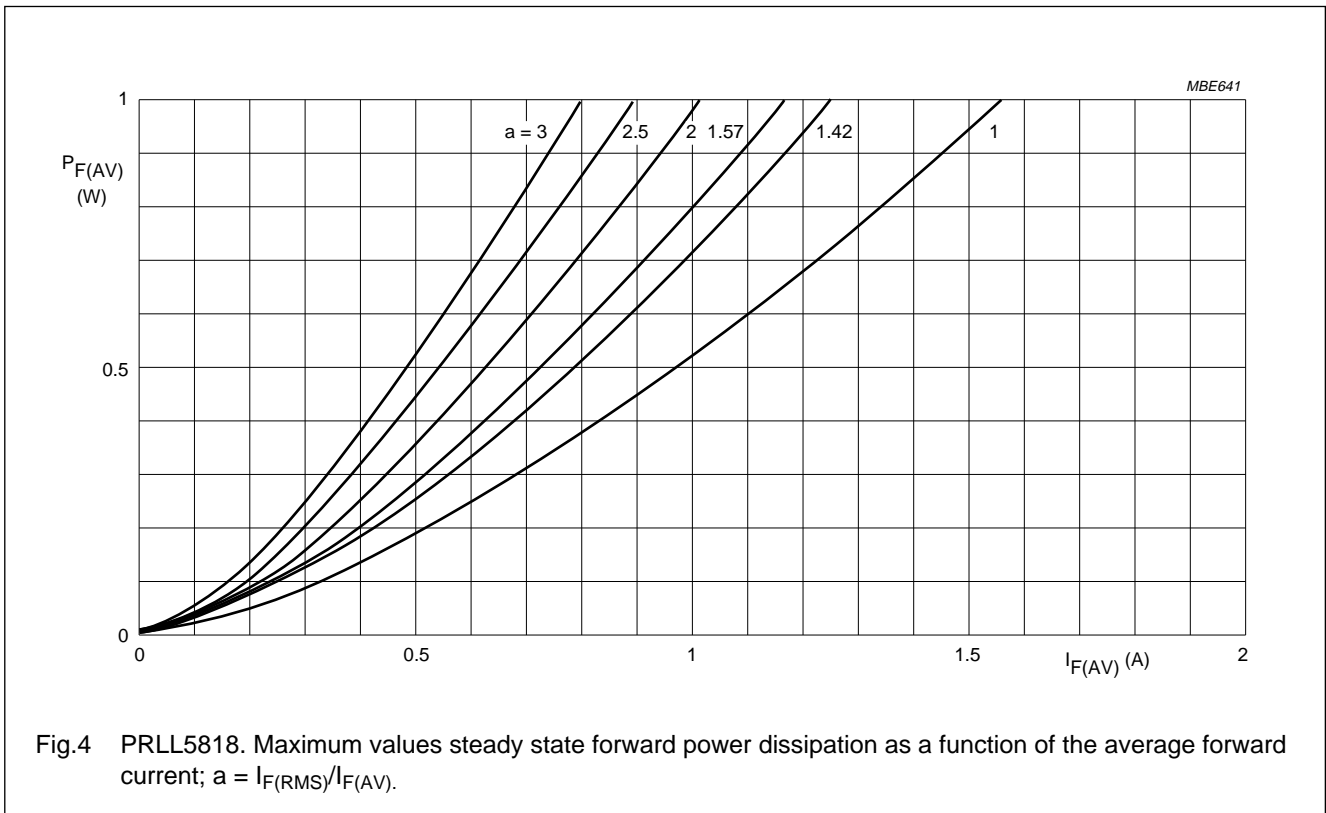

Fig.3 PRL5817. Maximum values steady state forward power dissipation as a function of the average forward current;  $a = I_{F(RMS)}/I_{F(AV)}$ .

Schottky barrier diodes

PRL5817; PRL5818; PRL5819



### Schottky barrier diodes

### PRLL5817; PRLL5818; PRLL5819

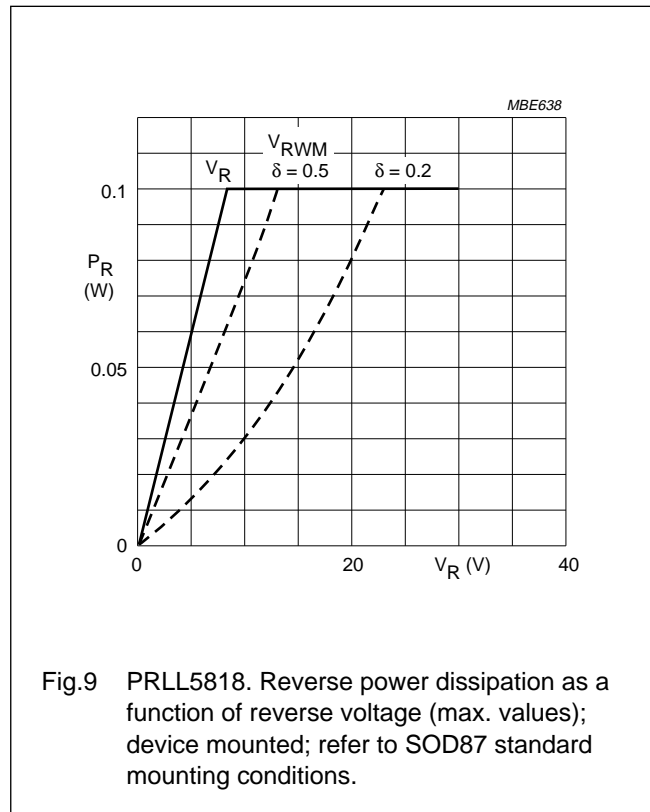
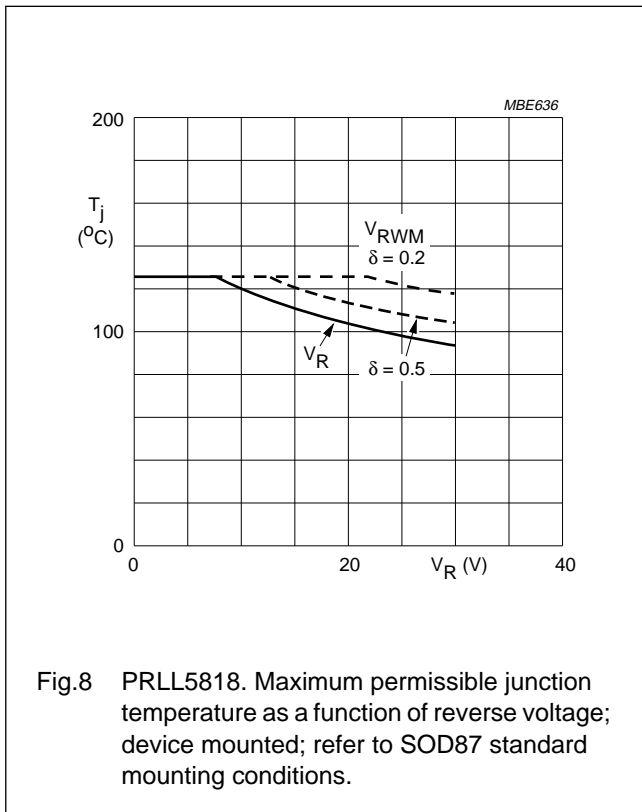
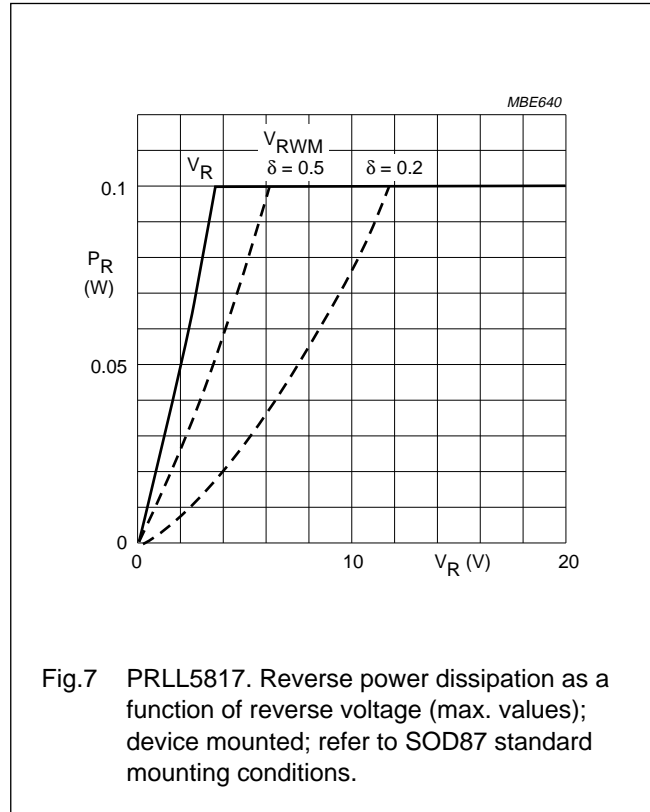
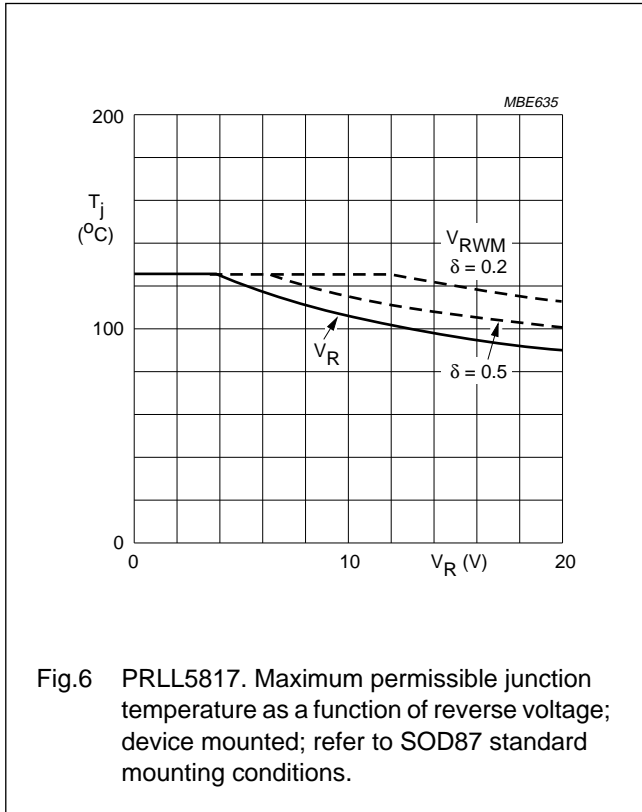

Schottky barrier diodes

PRL5817; PRL5818; PRL5819

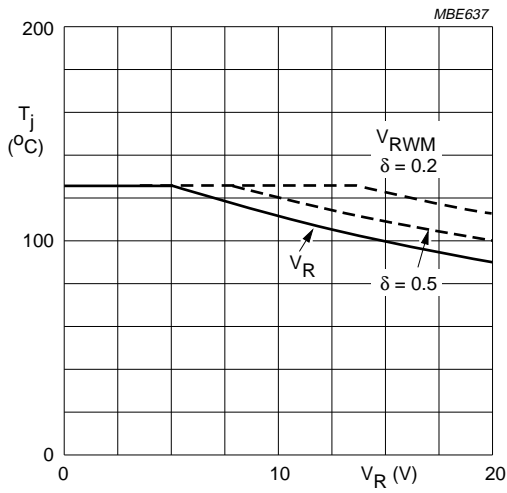

Fig.10 PRL5819. Maximum permissible junction temperature as a function of reverse voltage; device mounted; refer to SOD87 standard mounting conditions.

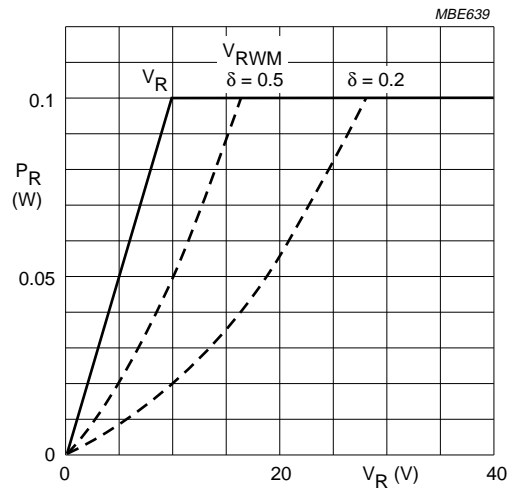

Fig.11 PRL5819. Reverse power dissipation as a function of reverse voltage (max. values); device mounted; refer to SOD87 standard mounting conditions.



Schottky barrier diodes

PRL5817; PRL5818; PRL5819

PACKAGE OUTLINE

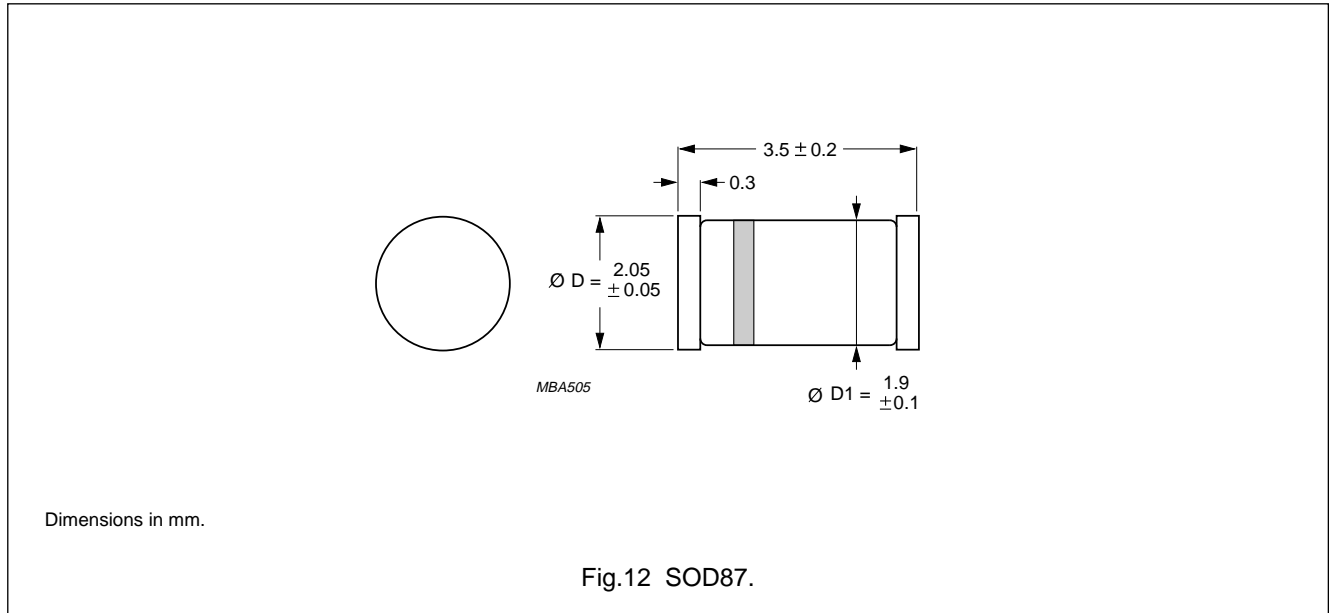

DEFINITIONS

<b>Data sheet status</b>	
Objective specification	This data sheet contains target or goal specifications for product development.
Preliminary specification	This data sheet contains preliminary data; supplementary data may be published later.
Product specification	This data sheet contains final product specifications.
<b>Limiting values</b>	
Limiting values given are in accordance with the Absolute Maximum Rating System (IEC 134). Stress above one or more of the limiting values may cause permanent damage to the device. These are stress ratings only and operation of the device at these or at any other conditions above those given in the Characteristics sections of the specification is not implied. Exposure to limiting values for extended periods may affect device reliability.	
<b>Application information</b>	
Where application information is given, it is advisory and does not form part of the specification.	

LIFE SUPPORT APPLICATIONS

These products are not designed for use in life support appliances, devices, or systems where malfunction of these products can reasonably be expected to result in personal injury. Philips customers using or selling these products for use in such applications do so at their own risk and agree to fully indemnify Philips for any damages resulting from such improper use or sale.