



Frontier Electronics Corp.

667 E. COCHRAN STREET, SIMI VALLEY, CA 93065

TEL: (805) 522-9998 FAX: (805) 522-9989

E-mail: frontiersales@frontierusa.com

Web: <http://www.frontierusa.com>

1A SUPER FAST RECOVERY RECTIFIER

SF10-005 THRU SF10-06

FEATURES

- LOW FORWARD VOLTAGE
- HIGH SURGE CAPABILITY
- SUPER FAST SWITCHING SPEED
- GOOD FOR SWITCHING MODE CIRCUIT

MECHANICAL DATA

- CASE: MOLDED PLASTIC, DO41, DIMENSIONS IN INCHES AND (MILLIMETERS)
- EPOXY: UL 94V-0 FLAME RETARDANT PLASTIC CASE
- LEADS: AXIAL LEADS, SOLDERABLE PER MIL-STD-202, METHOD 208
- MOUNTING POSITION: ANY
- WEIGHT: 0.34 GRAMS

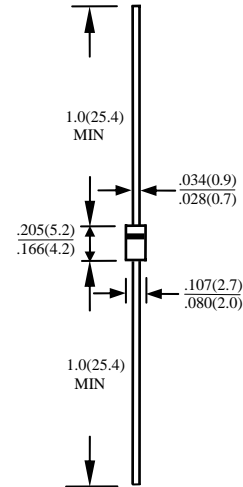

MAXIMUM RATINGS AND ELECTRICAL CHARACTERISTICS RATINGS AT 25°C AMBIENT TEMPERATURE UNLESS OTHERWISE SPECIFIED SINGLE PHASE, HALF WAVE, 60 HZ, RESISTIVE OR INDUCTIVE LOAD. FOR CAPACITIVE LOAD, DERATE CURRENT BY 20%

RATINGS	SYMBOL	SF10-005	SF10-01	SF10-015	SF10-02	SF10-03	SF10-04	SF10-05	SF10-06	UNITS
MAXIMUM RECURRENT PEAK REVERSE VOLTAGE	V_{RRM}	50	100	150	200	300	400	500	600	V
MAXIMUM RMS VOLTAGE	V_{RMS}	35	70	105	140	210	280	350	420	V
MAXIMUM DC BLOCKING VOLTAGE	V_{DC}	50	100	150	200	300	400	500	600	V
MAXIMUM AVERAGE FORWARD RECTIFIED CURRENT .375" (9.5mm) LEAD LENGTH AT $T_A=55^\circ\text{C}$	I_O	1.0								A
PEAK FORWARD SURGE CURRENT, 8.3ms SINGLE HALF SINE-WAVE SUPERIMPOSED ON RATED LOAD	I_{FSM}	30								A
TYPICAL JUNCTION CAPACITANCE (NOTE 1)	C_J	15				10				PF
TYPICAL THERMAL RESISTANCE (NOTE 2)	$R_{\theta ja}$	50								°C/W
STORAGE TEMPERATURE RANGE	T_{STG}	- 55 TO + 150								°C
OPERATING TEMPERATURE RANGE	T_{OP}	- 55 TO + 150								°C

ELECTRICAL CHARACTERISTICS ($A_T T_A = 25^\circ\text{C}$ UNLESS OTHERWISE NOTED)

CHARACTERISTICS	SYMBOL	SF10-005	SF10-01	SF10-015	SF10-02	SF10-03	SF10-04	SF10-05	SF10-06	UNITS
MAXIMUM FORWARD VOLTAGE AT I_O DC	V_F	0.95			1.25		1.85			V
MAXIMUM REVERSE CURRENT AT 25°C	I_R	10								μA
MAXIMUM REVERSE CURRENT AT 100°C	I_R	100								μA
MAXIMUM REVERSE RECOVERY TIME (NOTE 3)	T_{RR}	35								nS

NOTE : 1. MEASURED AT 1 MHZ AND APPLIED REVERSE VOLTAGE OF 4.0 VOLTS

2. BOTH LEADS ATTACHED TO HEATSINK 20×20×1(mm) COPPER PLATE AT LEAD LENGTH 5mm

3. REVERSE RECOVERY TEST CONDITIONS: $I_F=0.5\text{A}$, $I_R=1.0\text{A}$, $I_{RR}=0.25\text{A}$

RATINGS AND CHARACTERISTIC CURVE SF10-005 THRU SF10-06

FIG. 1-TEST CIRCUIT DIAGRAM AND REVERSE RECOVERY TIME CHARACTERISTIC

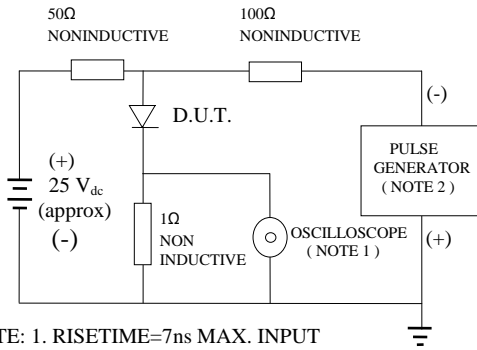

NOTE: 1. RISE TIME=7ns MAX. INPUT IMPEDANCE=1 MEGOHM 22PF
 2. RISE TIME =10ns MAX. SOURCE IMPEDANCE=50OHMS

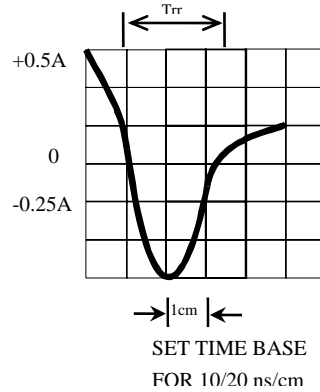

FIG. 2-TYPICAL FORWARD CURRENT DERATING CURVE

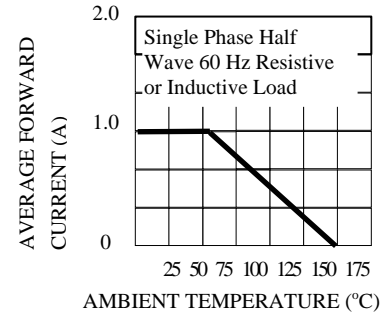

FIG. 3-TYPICAL REVERSE CHARACTERISTICS

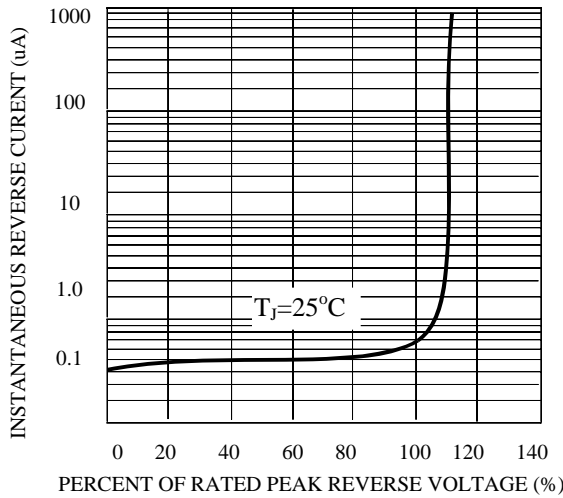

FIG. 4-TYPICAL INSTANTANEOUS FORWARD CHARACTERISTICS

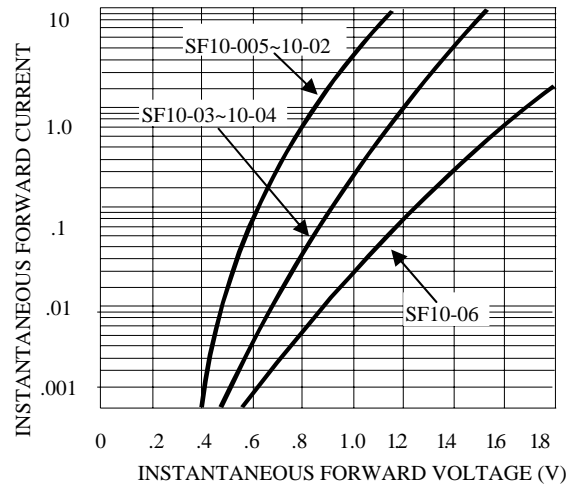

FIG. 5-MAXIMUM NON-REPETITIVE FORWARD SURGE CURRENT

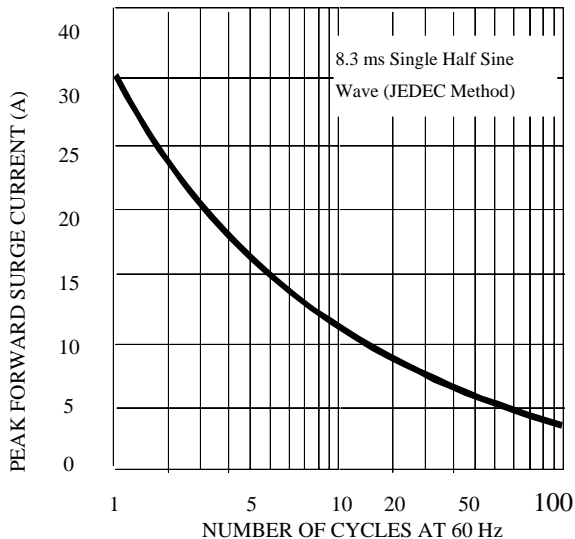

FIG. 6-TYPICAL JUNCTION CAPACITANCE

