

Miniature Bridge Rectifiers

- SKB B ... C 1000 L5B
- SKB B ... C 1500 L5B
- SKBa B 500 C 1000 L5B
- SKBa B 500 C 1500

V _{RSM} V _{RRM}	V _{VRMS} V	I _D (T _{amb} = 45 °C)					
		1,8 A			2,5 A		
V	V	Types	C _{max} μF	R _{min} Ω	Types	C _{max} μF	R _{min} Ω
120	40	SKB B 40 C 1000 L5B	5000	0,5	SKB B 40 C 1500 L5B	7000	0,4
400	125	SKB B 80 C 1000 L5B	1600	1,5	SKB B 80 C 1500 L5B	2200	1,1
800	250	SKB B 250 C 1000 L5B	800	3	SKB B 250 C 1500 L5B	1000	2,5
1000	380	SKB B 380 C 1000 L5B	600	4,5	SKB B 380 C 1500 L5B	700	4
1200	500	SKB B 500 C 1000 L5B	400	6	SKB B 500 C 1500 L5B	500	5
V _(BR) min	V _{VRMS} V	Avalanche Types					
1300	500	SKBa B 500 C 1000 L5B	400	6	SKBa B 500 C 1500	500	5

Symbol	Conditions	SKB B...C 1000 SKBa B 500 C 1000	SKB B...C 1500 SKBa B 500 C 1500
I _D	T _{amb} = 45 °C; isolated ¹⁾ chassis ²⁾	1,2 A 1,8 A	1,5 A -
I _{DCL}	T _{amb} = 33 °C; isolated ¹⁾ T _{amb} = 45 °C; isolated ¹⁾ chassis ²⁾	- 1 A 1,5 A	1,5 A - -
I _{FSM}	T _{vj} = 25 °C, 10 ms T _{vj} = 150 °C, 10 ms	58 A 50 A	80 A 70 A
i ² t	T _{vj} = 25 °C, 8,3 ... 10 ms T _{vj} = 150 °C, 8,3 ... 10 ms	17 A ² s 12,5 A ² s	32 A ² s 24,5 A ² s
P _{RSM}	t _p = 10 μs; avalanche types	1000 W	1000 W
V _F	T _{vj} = 25 °C; I _F = 10 A	1,65 V	1,5 V
V _(TO)	T _{vj} = 150 °C	0,85 V	0,85 V
r _T	T _{vj} = 150 °C	100 mΩ	60 mΩ
I _{RD}	T _{vj} = 25 °C; V _{RD} = V _{RRM} = 120 V ≥ 400 V V _{RD} = V _{(BR)min} T _{vj} = 150 °C; V _{RD} = V _{RRM} = 120 V ≥ 400 V		20 μA 5 μA 5 μA 1 mA 0,6 mA
t _{rr}	T _{vj} = 25 °C		typ. 10 μs
f _G			2000 Hz
R _{thja}	isolated ¹⁾ chassis ²⁾	42 °C/W 27 °C/W	36 °C/W -
T _{vj}		- 40...+ 150 °C	
T _{stg}		- 55...+ 150 °C	
RC	P _R = 1 W	10 nF + 20...50 Ω	
F _u		1,5 A	2 A
w		2 g	2 g
Case		G 2	

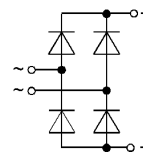
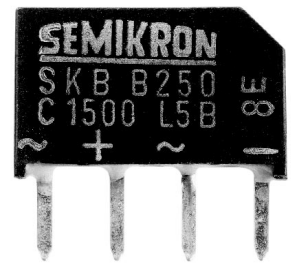

Features

- Compact plastic package with in-line terminals
- High blocking voltage
- SKBa with avalanche characteristics

Typical Applications

- Internal power supplies for electronic equipment
- DC power supplies
- Control equipment
- TV sets
- Avalanche types for inductive loads:
Solenoids,
Motor brakes

1) Freely suspended or mounted on an insulator

2) Mounted on a painted metal sheet of min. 250 x 250 x 1 mm

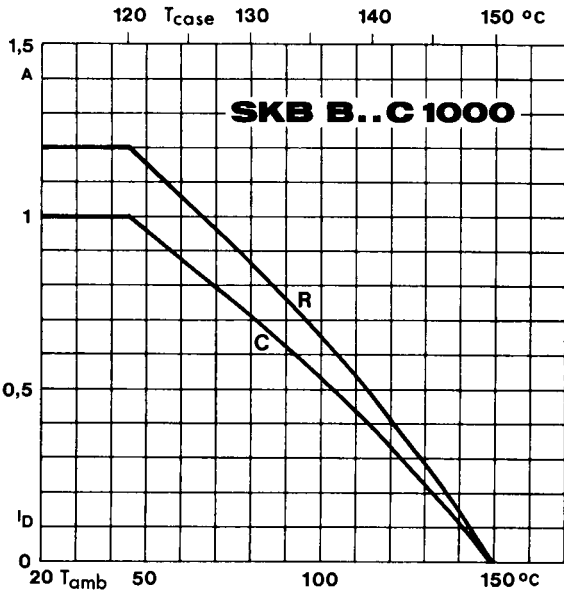

Fig. 1 a Rated output current vs. ambient temperature

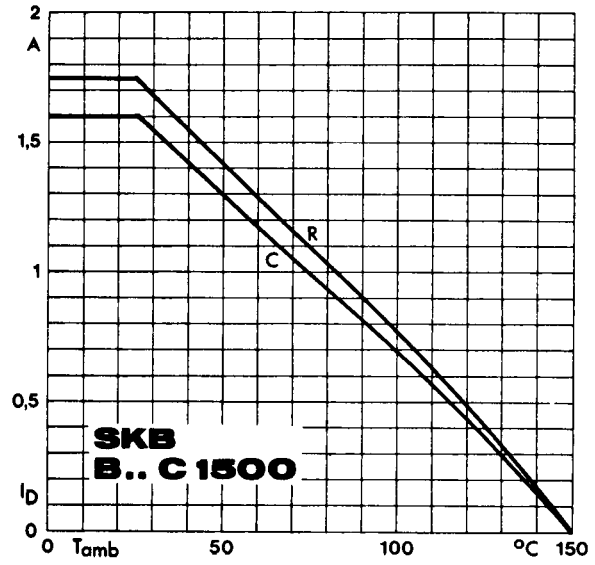

Fig. 1 b Rated output current vs. ambient temperature

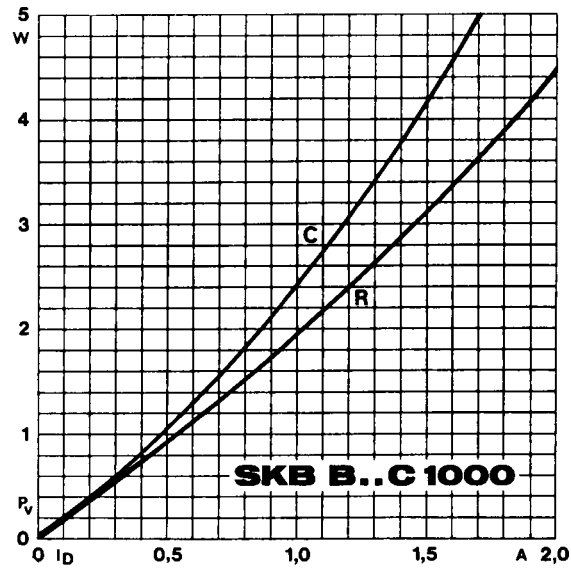

Fig. 2 a Power dissipation vs. output current

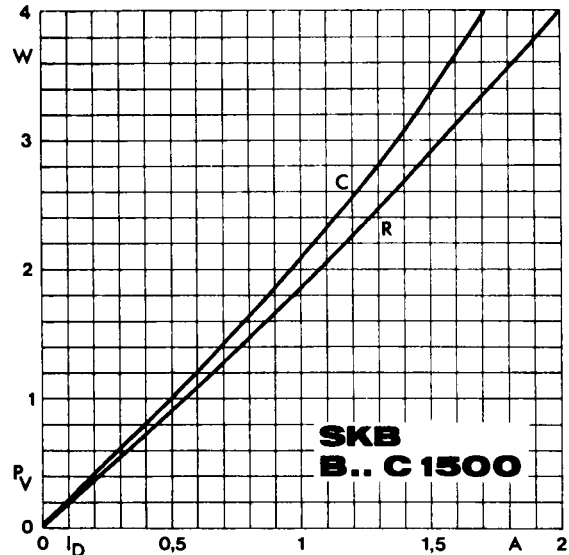

Fig. 2 b Power dissipation vs. output current

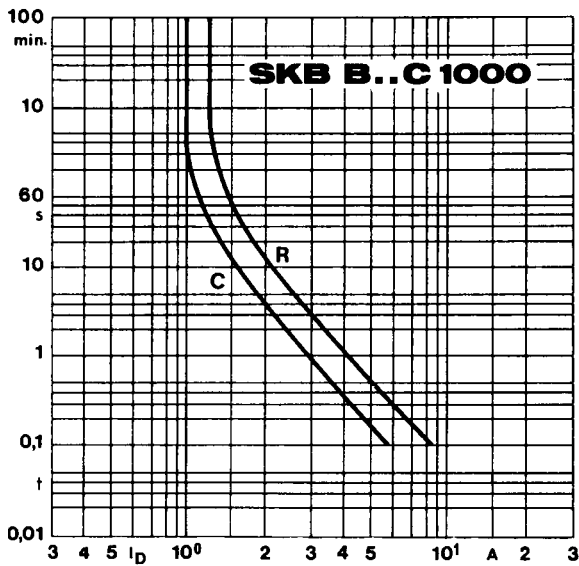

Fig. 6 a Rated overload current vs. time

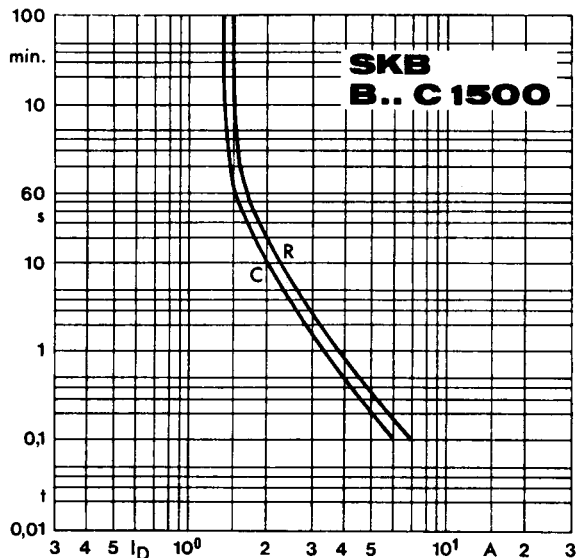

Fig. 6 b Rated overload current vs. time

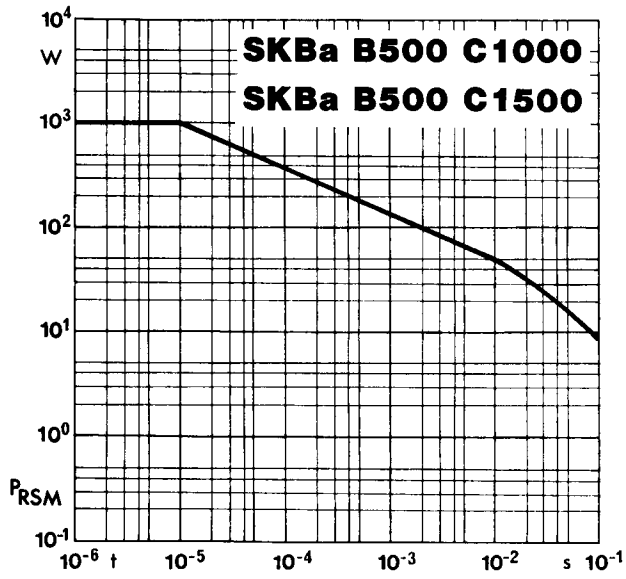

Fig. 7 Rated reverse power dissipation vs. time

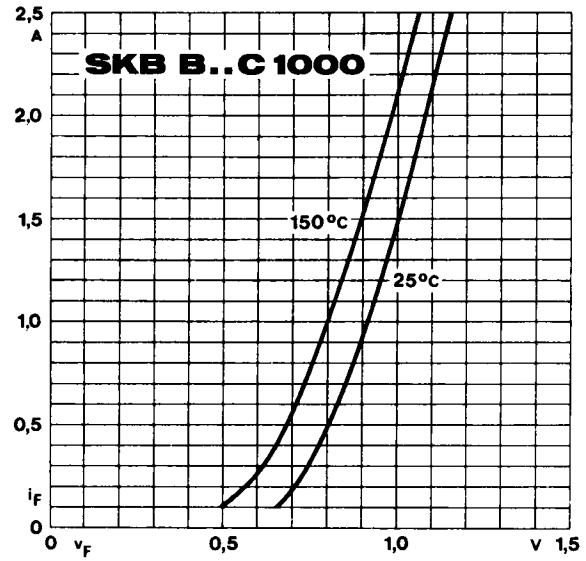

Fig. 9 a Forward characteristics of a single diode

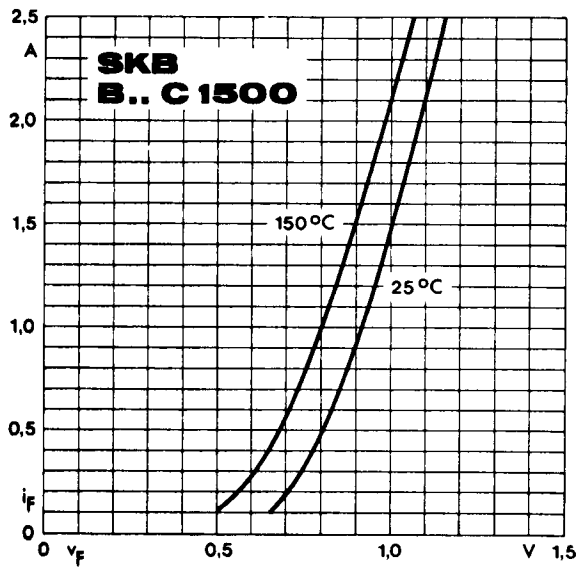
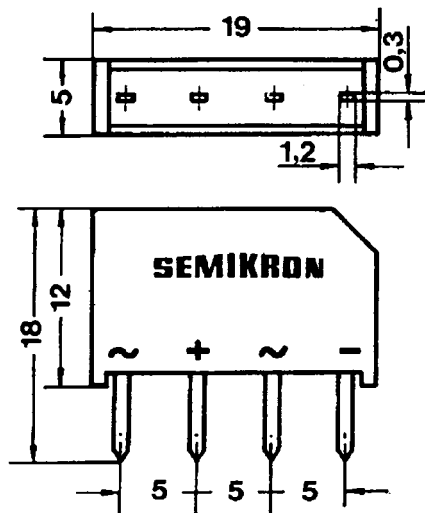
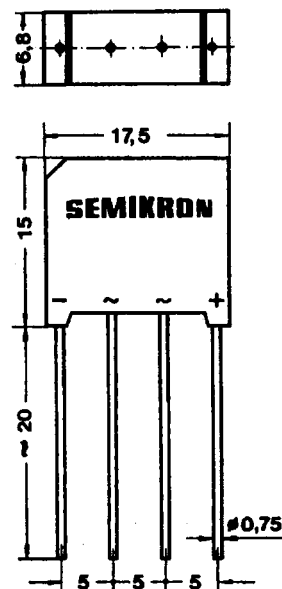

Fig. 9 b Forward characteristics of a single diode

SKB B... C 1000 L5B SKB B... C 1500 L5B
 SKBa B 500 C 1000 L5B SKBa B 500 C 1500
 Case G 2



SKB 2
 Case G 4



Dimensions in mm