

Features

- Low Forward Voltage
- Epitaxial Construction with Oxide Passivation
- Guard Ring for Transient and ESD Protection
- Surge Overload Rating to 100A Peak
- Low Power Loss
- Fast Switching
- Ideally Suited for Use in High Frequency SMPS, Inverters and As Free Wheeling Diodes

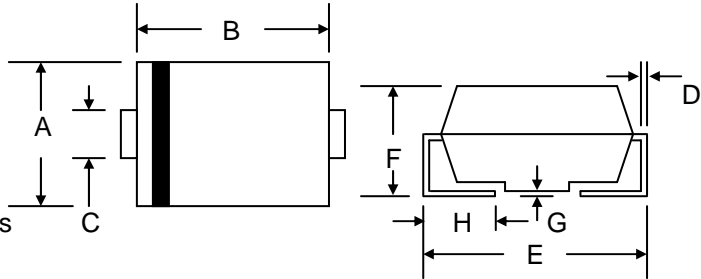

Mechanical Data

- Case: SMB/DO-214AA, Molded Plastic
- Terminals: Solder Plated, Solderable per MIL-STD-750, Method 2026
- Polarity: Cathode Band or Cathode Notch
- Marking: Type Number
- Weight: 0.093 grams (approx.)
- **Lead Free: For RoHS / Lead Free Version, Add "-LF" Suffix to Part Number, See Page 4**

SMB/DO-214AA		
Dim	Min	Max
A	3.30	3.94
B	4.06	4.70
C	1.91	2.11
D	0.152	0.305
E	5.08	5.59
F	2.13	2.44
G	0.051	0.203
H	0.76	1.27
All Dimensions in mm		

Maximum Ratings @ $T_A=25^\circ\text{C}$ unless otherwise specified

Characteristic	Symbol	SR32	SR33	SR34	SR35	SR36	SR38	SR39	SR310	Unit	
Peak Repetitive Reverse Voltage	V_{RRM}									V	
Working Peak Reverse Voltage	V_{RWM}	20	30	40	50	60	80	90	100		
DC Blocking Voltage	V_R										
RMS Reverse Voltage	$V_{R(RMS)}$	14	21	28	35	42	56	63	70	V	
Average Rectified Output Current (Note 1)	I_O	3.0								A	
Non-Repetitive Peak Forward Surge Current 8.3ms Single Half Sine-Wave Superimposed on Rated Load (JEDEC Method)	I_{FSM}	100								A	
Forward Voltage @ $I_F = 3.0\text{A}$	V_{FM}	0.50			0.75		0.85			V	
Peak Reverse Current @ $T_J = 25^\circ\text{C}$ At Rated DC Blocking Voltage @ $T_J = 100^\circ\text{C}$	I_{RM}	0.5					20				mA
Typical Junction Capacitance (Note 2)	C_J	250			180		140			pF	
Thermal Resistance, Junction to Ambient (Note 1)	R_{JA}	75								$^\circ\text{C}/\text{W}$	
Thermal Resistance, Junction to Case (Note 1)	R_{JC}	20									
Operating Temperature Range	T_J	-55 to +125				-55 to +150				$^\circ\text{C}$	
Storage Temperature Range	T_{STG}	-55 to +150								$^\circ\text{C}$	

Note: 1. Mounted on FR-4 PCB with 8.0 x 8.0mm copper pads.
2. Measured at 1.0 MHz and applied reverse voltage of 4.0V D.C.

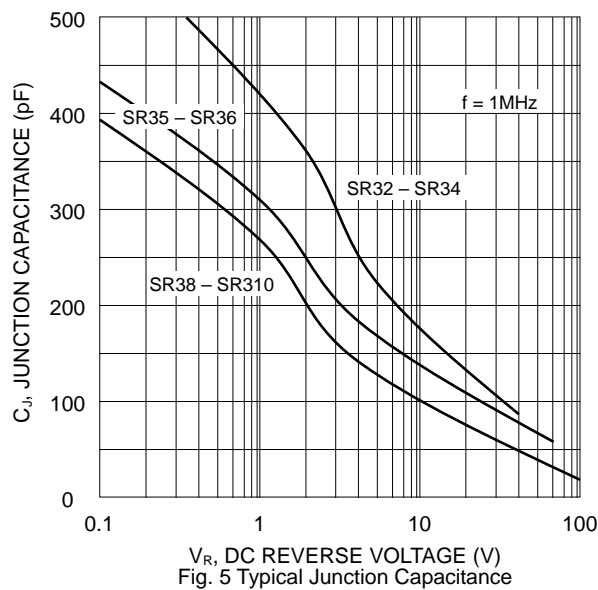
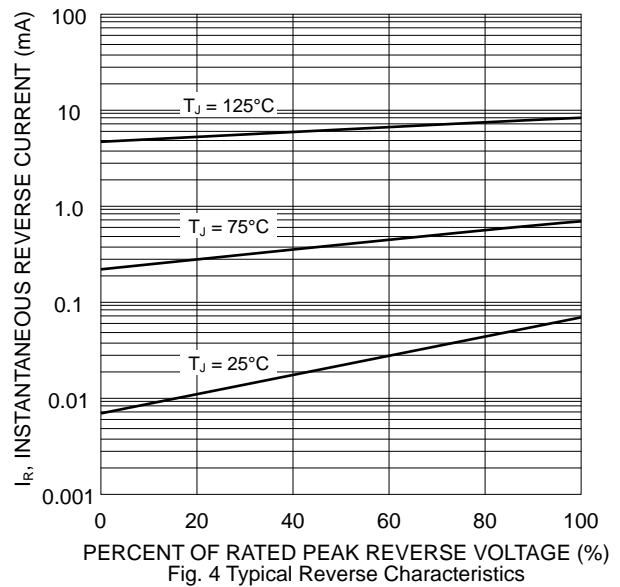
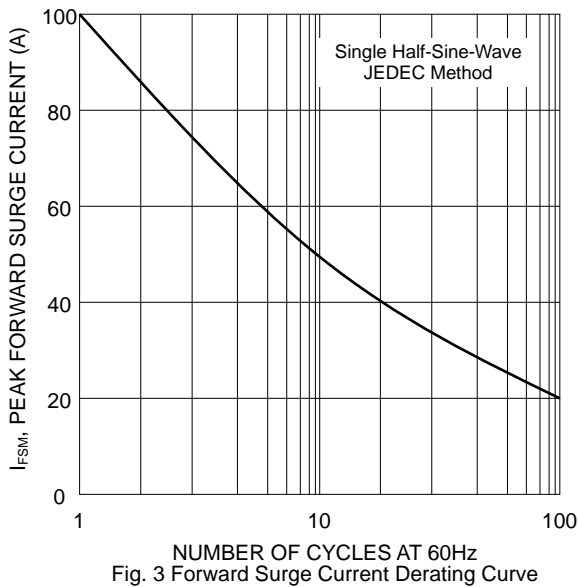
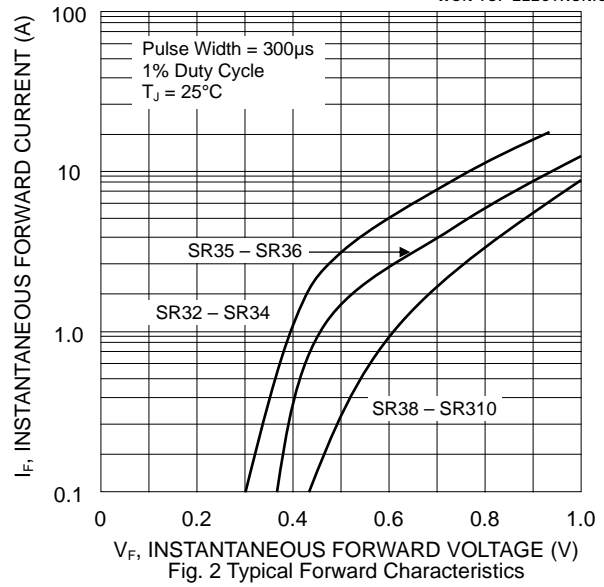
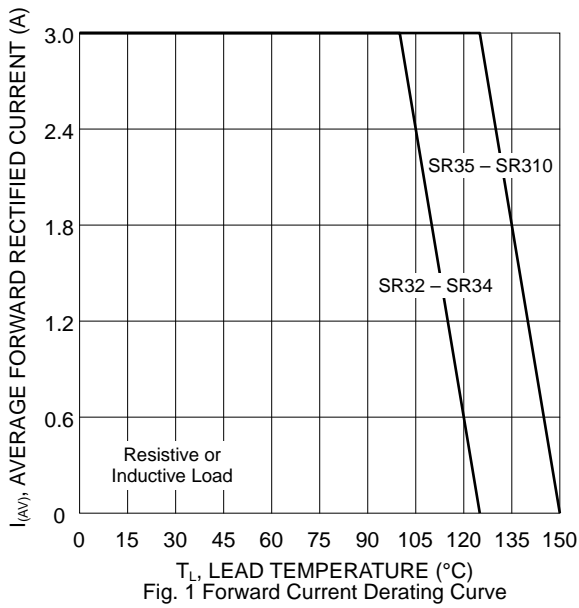

MARKING INFORMATION

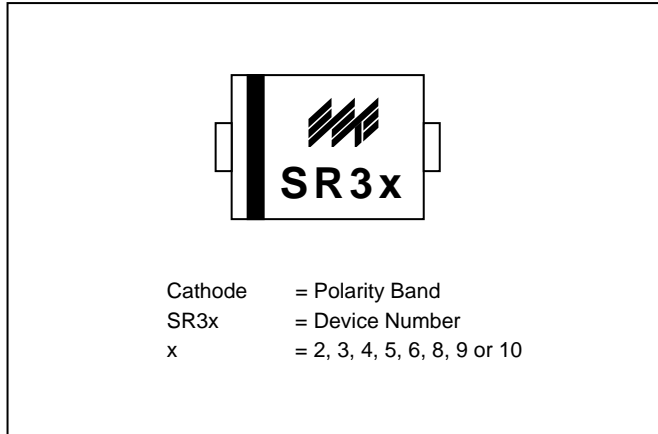

RECOMMENDED FOOTPRINT

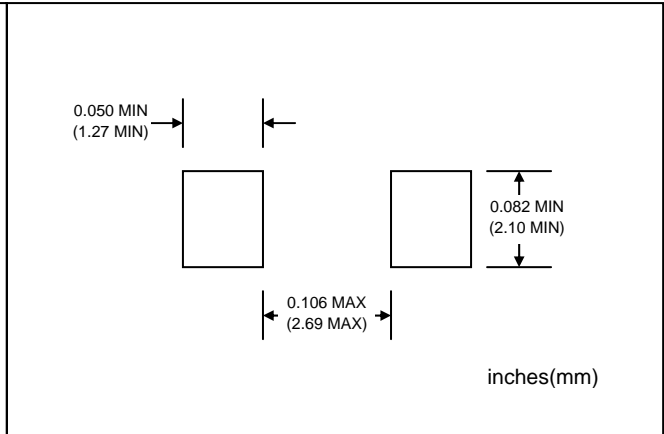

PACKAGING INFORMATION

TAPE & REEL

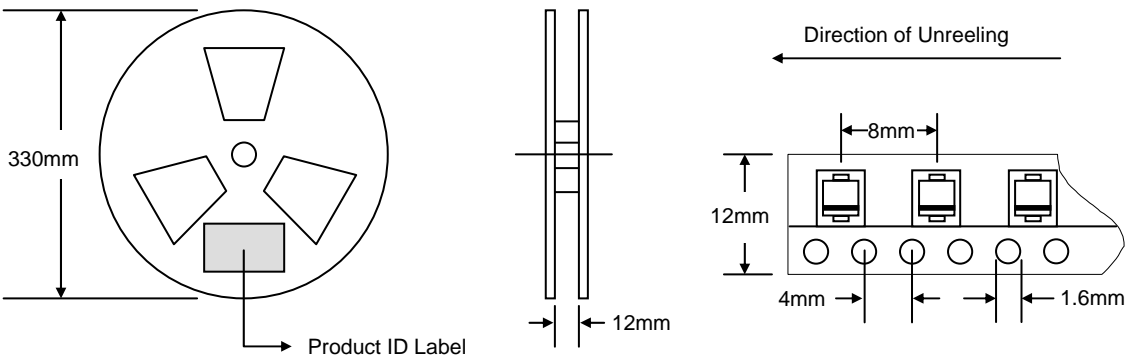

Reel Diameter (mm)	Quantity (PCS)	Inner Box Size L x W x H (mm)	Quantity (PCS)	Carton Size L x W x H (mm)	Quantity (PCS)	Approx. Gross Weight (KG)
330	3,000	340 x 337 x 45	6,000	370 x 370 x 420	48,000	14.0

Note: 1. Paper reel, white or gray color.
 2. Components are packed in accordance with EIA standard 481-1 and 481-2.

ORDERING INFORMATION

Product No.	Package Type	Shipping Quantity
SR32-T3	SMB	3000/Tape & Reel
SR33-T3	SMB	3000/Tape & Reel
SR34-T3	SMB	3000/Tape & Reel
SR35-T3	SMB	3000/Tape & Reel
SR36-T3	SMB	3000/Tape & Reel
SR38-T3	SMB	3000/Tape & Reel
SR39-T3	SMB	3000/Tape & Reel
SR310-T3	SMB	3000/Tape & Reel

- Shipping quantity given is for minimum packing quantity only. For minimum order quantity, please consult the Sales Department.
- To order RoHS / Lead Free version (with Lead Free finish), add "-LF" suffix to part number above. For example, SR32-T3-LF.

WON-TOP ELECTRONICS and  are registered trademarks of Won-Top Electronics Co., Ltd (WTE). WTE has checked all information carefully and believes it to be correct and accurate. However, WTE cannot assume any responsibility for inaccuracies. Furthermore, this information does not give the purchaser of semiconductor devices any license under patent rights to manufacturer. WTE reserves the right to change any or all information herein without further notice.

WARNING: DO NOT USE IN LIFE SUPPORT EQUIPMENT. WTE power semiconductor products are not authorized for use as critical components in life support devices or systems without the express written approval.

Won-Top Electronics Co., Ltd.
 No. 44 Yu Kang North 3rd Road,
 Chine Chen Dist., Kaohsiung 806, Taiwan
Phone: 886-7-822-5408 or 886-7-822-5410
Fax: 886-7-822-5417
Email: sales@wontop.com
Internet: http://www.wontop.com

We power your everyday.