

MINIATURE RELAY

1 POLE—1 A (FOR SIGNAL SWITCHING)

SY SERIES

■ FEATURES

- Very small size and light weight
- UL, CSA recognized
- Conforms to FCC rules and regulations part 68
 - Dielectric strength 1000 VAC between coil and contacts
 - Surge strength 1500 V
- High sensitivity
- Wide ambient temperature range (-30°C to +90°C)
- Wide operating range
- DIL pitch terminals
- Plastic sealed type
- Dial-pulse relay available (10pps, 20pps)

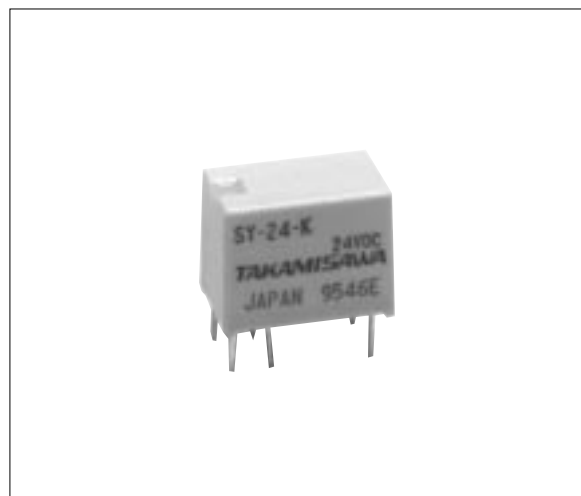

■ ORDERING INFORMATION

[Example] $\frac{SY}{(a)} - \frac{12}{(b)} \frac{W}{(c)} - \frac{K}{(d)}$

(a)	Series Name	SY: SY Series
(b)	Nominal Voltage	Refer to the COIL DATA CHART
(c)	Contact	Nil: Single type W: Bifurcated type
(d)	Enclosure	K: Plastic sealed type

Note: For movable and stationary contact with gold overlay type, add suffix “-OH”

■ SAFETY STANDARD AND FILE NUMBERS

UL478, 508 (File No. E45026)

C22.2 No. 14 (File No. LR35579)

Please request when the approval markings are required on the cover.

Nominal voltage	Contact rating
1.5 to 24 VDC	0.5 A 120 VAC
	1 A 30 VDC
	0.15 A 48 VDC
	— resistive

■ SPECIFICATIONS

Item		SY-()-K (Single)	SY-() W - K (Bifurcated)	
Contact	Arrangement	1 form C (SPDT)		
	Material	Gold overlay silver alloy		
	Resistance (initial)	Maximum 100 mΩ (at 1 A 6 VDC)		
	Rating (resistive)	0.5 A 120 VAC or 1 A 24 VDC		
	Maximum Carrying Current	2 A		
	Maximum Switching Power	60 AV, 24 W		
	Maximum Switching Voltage	120 VAC/60 VDC		
	Maximum Switching Current	1 A		
	Minimum Switching Load*1	1 mA 1 VDC	0.1 mA 100 mVDC	
	Capacitance (at 10 MHz)	Approximately 1.4 pF (between open contacts) Approximately 5.0 pF (between coil and contacts)		
Coil	Nominal Power (at 20°C)	0.15 to 0.175 W		
	Operate Power (at 20°C)	0.075 to 0.086 W		
	Operating Temperature	-30°C to +90°C (no frost)/18 V coil: +85°C, 24 V coil: +80°C		
Time Value	Operate (at nominal voltage)	Maximum 5 ms		
	Release (at nominal voltage)	Maximum 2 ms		
Insulation	Resistance	Minimum 1,000 MΩ (at 500 VDC)	Minimum 1,000 MΩ (at 250 VDC)	
	Dielectric strength	between open contacts	400 VAC 1 minute	300 VAC 1 minute
		between coil and contacts	1,000 VAC 1 minute	
	Surge Strength	1,500 V		
Life	Mechanical	5 × 10 ⁶ operations minimum		
	Electrical (at contact rating)	1 × 10 ⁵ operations minimum	1 × 10 ⁵ operations minimum	
Other	Vibration Resistance	Misoperation	10 to 55 Hz (double amplitude of 1.5 mm)	
		Endurance	10 to 55 Hz (double amplitude of 1.5 mm)	
	Shock Resistance	Misoperation	300 m/s ² (11 ±1 ms)	
		Endurance	1,000 m/s ² (6 ±1 ms)	
	Weight	Approximately 1.7 g		

*1 Minimum switching loads mentioned above are reference values. Please perform the confirmation test with the actual load before production since reference values may vary according to switching frequencies, environmental conditions and expected reliability levels.

COIL DATA CHART

MODEL		Nominal voltage	Coil resistance ($\pm 10\%$)	Must operate voltage	Must release voltage	Nominal power
Single	Bifurcated					
SY-1.5-K	SY-1.5W-K	1.5 VDC	15 Ω	1.05 VDC	0.08 VDC	150 mW
SY- 3 -K	SY- 3 W-K	3 VDC	60 Ω	2.1 VDC	0.15 VDC	150 mW
SY-4.5-K	SY-4.5W-K	4.5 VDC	135 Ω	3.2 VDC	0.23 VDC	150 mW
SY- 5 -K	SY- 5 W-K	5 VDC	167 Ω	3.5 VDC	0.25 VDC	150 mW
SY- 6 -K	SY- 6 W-K	6 VDC	240 Ω	4.2 VDC	0.3 VDC	150 mW
SY- 9 -K	SY- 9 W-K	9 VDC	540 Ω	6.3 VDC	0.45 VDC	150 mW
SY-12 -K	SY-12 W-K	12 VDC	960 Ω	8.4 VDC	0.6 VDC	150 mW
SY-18 -K	SY-18 W-K	18 VDC	1,940 Ω	12.6 VDC	0.9 VDC	170 mW
SY-24 -K	SY-24 W-K	24 VDC	3,290 Ω	16.8 VDC	1.2 VDC	175 mW

Note : All values in the table are measured at 20°C.

CHARACTERISTIC DATA

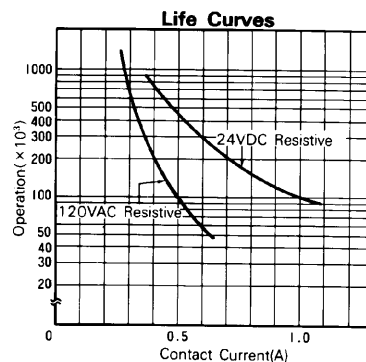
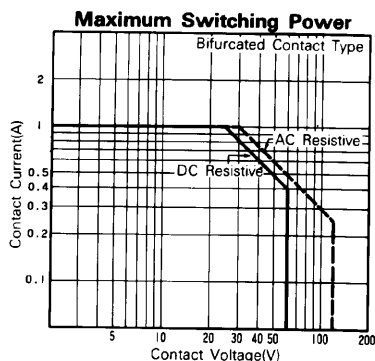
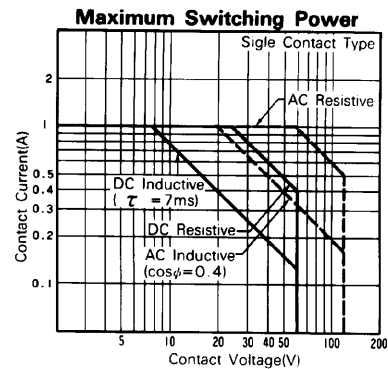
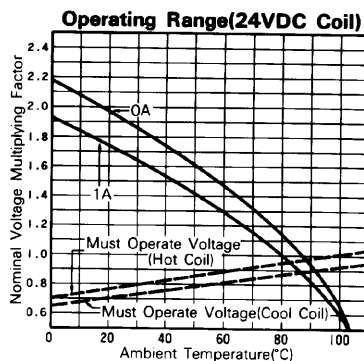
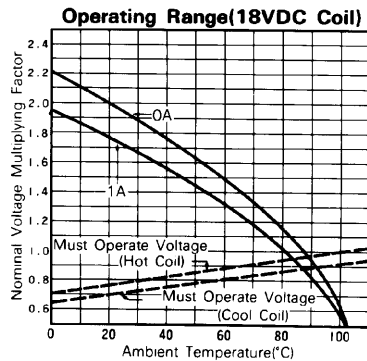
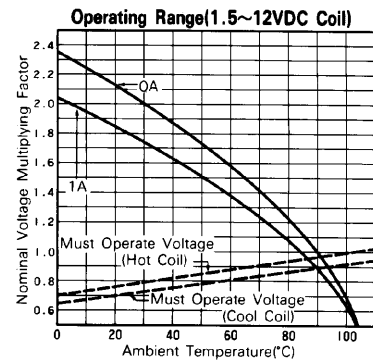
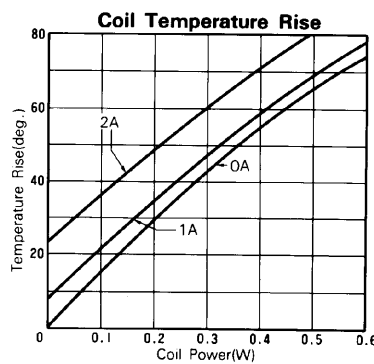
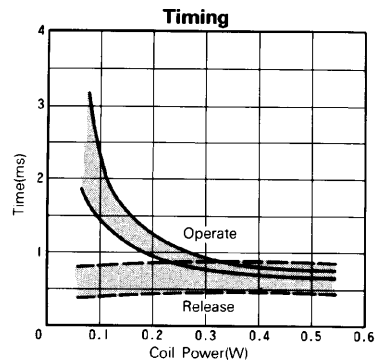

REFERENCE DATA

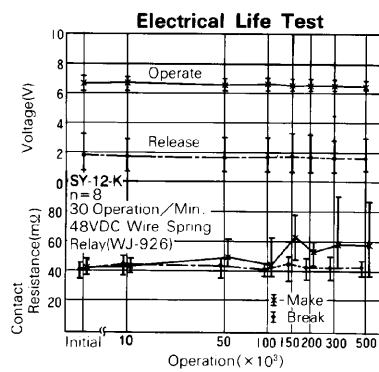
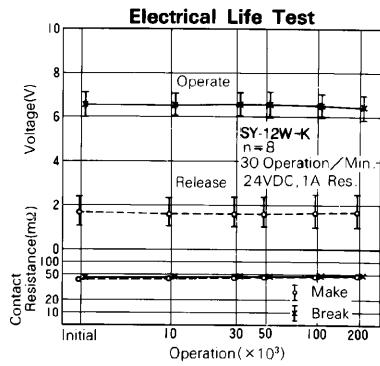
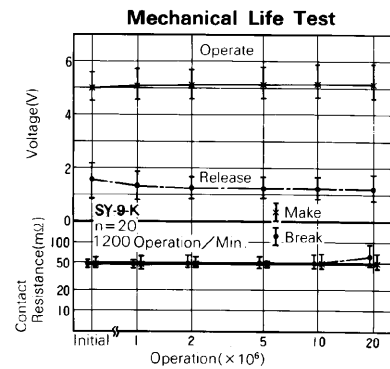
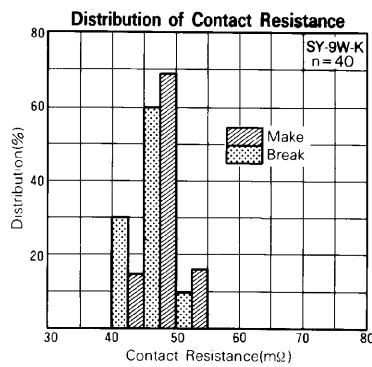
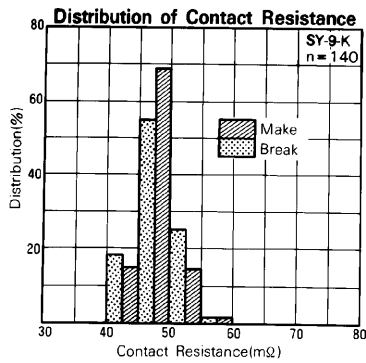
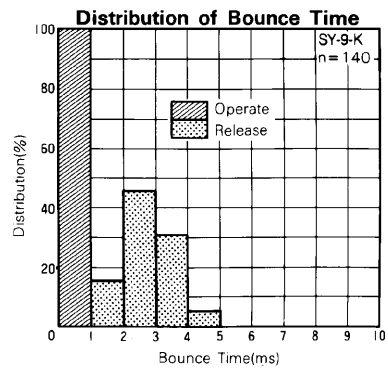
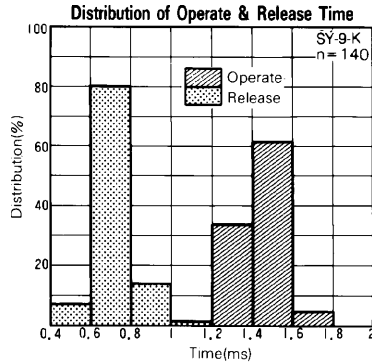
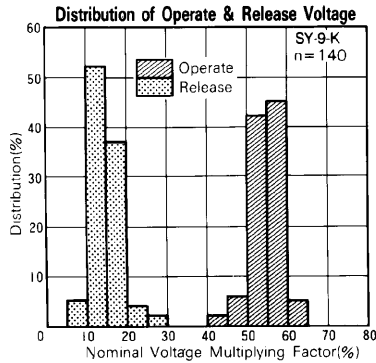

DIMENSIONS

Dimensions

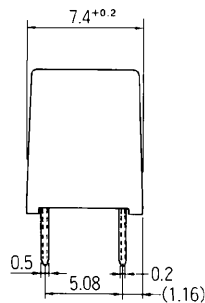
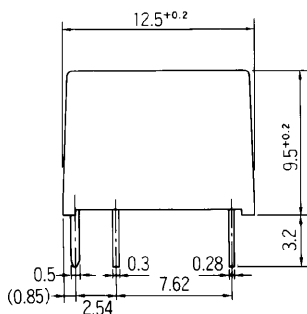

Schematics (Bottom View)

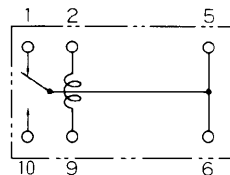

PC board mounting hole layout (Bottom View)

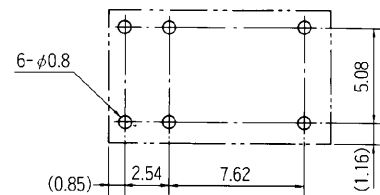

Unit: mm

Fujitsu Components International Headquarter Offices

Japan

Fujitsu Component Limited
Gotanda-Chuo Building
3-5, Higashigotanda 2-chome, Shinagawa-ku
Tokyo 141, Japan
Tel: (81-3) 5449-7010
Fax: (81-3) 5449-2626
Email: promothq@ft.ed.fujitsu.com
Web: www.fcl.fujitsu.com

North and South America

Fujitsu Components America, Inc.
250 E. Caribbean Drive
Sunnyvale, CA 94089 U.S.A.
Tel: (1-408) 745-4900
Fax: (1-408) 745-4970
Email: marcom@fcai.fujitsu.com
Web: www.fcai.fujitsu.com

Europe

Fujitsu Components Europe B.V.
Diamantlaan 25
2132 WV Hoofddorp
Netherlands
Tel: (31-23) 5560910
Fax: (31-23) 5560950
Email: info@fceu.fujitsu.com
Web: www.fceu.fujitsu.com

Asia Pacific

Fujitsu Components Asia Ltd.
102E Pasir Panjang Road
#04-01 Citilink Warehouse Complex
Singapore 118529
Tel: (65) 6375-8560
Fax: (65) 6273-3021
Email: fcal@fcal.fujitsu.com
www.fcal.fujitsu.com

© 2003 Fujitsu Components America, Inc. All company and product names are trademarks or registered trademarks of their respective owners. Rev. 02/12/2003