

TOSHIBA CMOS DIGITAL INTEGRATED CIRCUIT SILICON MONOLITHIC

# TC4W53F, TC4W53FU

## 2-CHANNEL MULTIPLEXER / DEMULTIPLEXER

The TC4W53 is multiplexer with capabilities of selection and mixture of analog signal and digital signal. TC4W53F has 2 channel configuration. The digital signal to the control terminal turns "ON" the corresponding switch of each channel, with large amplitude ( $V_{DD}-V_{EE}$ ) can be switched by the control signal with small logical amplitude ( $V_{DD}-V_{SS}$ ). For example, in the case of  $V_{DD}=5V$ ,  $V_{SS}=0V$  and  $V_{EE}=-5V$ , signals between  $-5V$  and  $+5V$  can be switched from the logical circuit with signal power supply of 5 volts. As the ON-resistance of each switch is low, these can be connected to the circuits with low input impedance.

### MAXIMUM RATINGS

CHARACTERISTIC	SYMBOL	RATING	UNIT
DC Supply Voltage	$V_{DD}-V_{SS}$	$-0.5\sim 20$	V
DC Supply Voltage	$V_{DD}-V_{EE}$	$-0.5\sim 20$	V
Control Input Voltage	$V_{CIN}$	$V_{SS}-0.5\sim V_{DD}+0.5$	V
Switch I/O Voltage	$V_I/V_O$	$V_{EE}-0.5\sim V_{DD}+0.5$	V
Control Input Current	$I_{CIN}$	$\pm 10$	mA
Potential difference across I/O during ON	$V_{I-O}$	$-0.5\sim 0.5$	V
Power Dissipation	$P_D$	300	mW
Operating Temperature	$T_{opr}$	$-40\sim 85$	$^{\circ}C$
Storage Temperature	$T_{stg}$	$-65\sim 150$	$^{\circ}C$
Lead Temperature (10s)	$T_L$	260	$^{\circ}C$

### LOGIC DIAGRAM

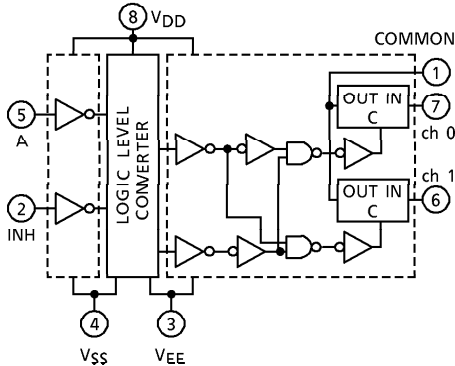

### TRUTH TABLE

CONTROL INPUT		ON CHANNEL
INH	A	
L	L	ch 0
L	H	ch 1
H	x	NONE

x : Don't Care

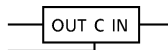

### TRUTH TABLE

CONTROL C	IMPE-DANCE BETWEEN IN-OUT
H	$0.5\sim 5 \times 10^2 \Omega$
L	$> 10^9 \Omega$

### PIN ASSIGNMENT (TOP VIEW)

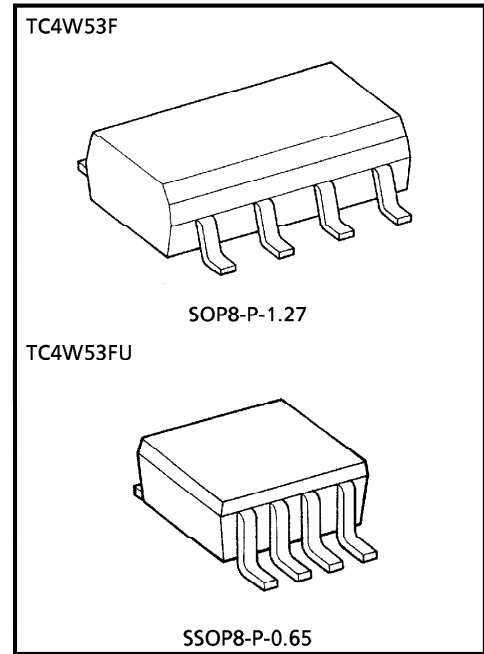
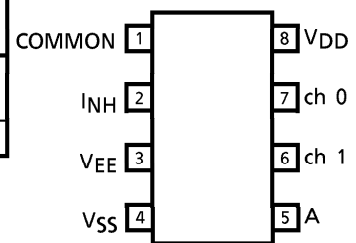

Weight SOP8-P-1.27 : 0.05g (Typ.)  
SSOP8-P-0.65 : 0.02g (Typ.)

### MARKING

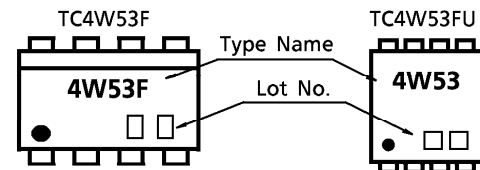

961001EBA2

● TOSHIBA is continually working to improve the quality and the reliability of its products. Nevertheless, semiconductor devices in general can malfunction or fail due to their inherent electrical sensitivity and vulnerability to physical stress. It is the responsibility of the buyer, when utilizing TOSHIBA products, to observe standards of safety, and to avoid situations in which a malfunction or failure of a TOSHIBA product could cause loss of human life, bodily injury or damage to property. In developing your designs, please ensure that TOSHIBA products are used within specified operating ranges as set forth in the most recent products specifications. Also, please keep in mind the precautions and conditions set forth in the TOSHIBA Semiconductor Reliability Handbook.

RECOMMENDED OPERATING CONDITIONS

CHARACTERISTIC	SYMBOL		MIN.	TYP.	MAX.	UNIT
DC Supply Voltage	$V_{DD}-V_{SS}$	—	3	—	18	V
	$V_{DD}-V_{EE}$	—	3	—	18	V
Control Input Voltage	$V_{IN}$	—	$V_{SS}$	—	$V_{DD}$	V
Input / Output Voltage	$V_{IN}-V_{OUT}$	—	$V_{EE}$	—	$V_{DD}$	V

DC ELECTRICAL CHARACTERISTICS

CHARACTERISTIC	SYM-BOL	TEST CONDITION			-40°C		25°C			85°C		UNIT	
		$V_{SS}$ (V)	$V_{EE}$ (V)	$V_{DD}$ (V)	MIN.	MAX.	MIN.	TYP.	MAX.	MIN.	MAX.		
Control Input High Voltage	$V_{IH}$	$V_{IS} = V_{DD}$ thru $1k\Omega$	$V_{EE} = V_{SS}$ $R_L = 1k\Omega$ to $V_{SS}$ $I_{LS} < 2\mu A$ on all OFF Channels	5	3.5	—	3.5	2.75	—	3.5	—	V	
				10	7.0	—	7.0	5.50	—	7.0	—		
				15	11.0	—	11.0	8.25	—	11.0	—		
Control Input Low Voltage	$V_{IL}$			5	—	1.5	—	2.25	1.5	—	1.5		—
				10	—	3.0	—	4.5	3.0	—	3.0		—
				15	—	4.0	—	6.75	4.0	—	4.0		—
On-State Resistance	$R_{ON}$	$0 \leq V_{IS} \leq V_{DD}$ $R_L = 10k\Omega$	0	0	5	—	850	—	240	950	—	1200	$\Omega$
			0	0	10	—	210	—	110	250	—	300	
			0	0	15	—	140	—	80	160	—	200	
$\Delta$ ON-State Resistance Between 2 Switches	$\Delta R_{ON}$	—	0	0	5	—	—	—	10	—	—	—	$\Omega$
			0	0	10	—	—	—	6	—	—	—	
			0	0	15	—	—	—	4	—	—	—	
Input / Output Leakage Current	$I_{OFF}$	$V_{IN} = 18V, V_{OUT} = 0V$ $V_{IN} = 0V, V_{OUT} = 18V$	18	—	$\pm 100$	—	$\pm 0.01$	$\pm 100$	—	$\pm 1000$	—	$\pm 1000$	nA
			18	—	$\pm 100$	—	$\pm 0.01$	$\pm 100$	—	$\pm 1000$	—	$\pm 1000$	
Quiescent Device Current	$I_{DD}$	$V_{IN} = V_{SS}, V_{DD} *$	5	—	5.0	—	0.005	5.0	—	150	—	150	$\mu A$
			10	—	10	—	0.010	10	—	300	—	300	
			15	—	20	—	0.015	20	—	600	—	600	
Input Current	$I_{IN}$	$V_{IH} = 18V, V_{IL} = 0V$	18	—	0.1	—	$10^{-5}$	0.1	—	1.0	—	1.0	$\mu A$
			18	—	-0.1	—	$-10^{-5}$	-0.1	—	-1.0	—	-1.0	
Input Capacitance	$C_{IN}$	—	—	—	—	—	5	7.5	—	—	—	pF	
Switch Input Capacitance	$C_{IN}$	—	—	—	—	—	10	—	—	—	—	pF	
Switch Output Capacitance	$C_{OUT}$	—	—	—	—	—	17	—	—	—	—		
Feedthrough Capacitance	$C_{IN-OUT}$	—	—	—	—	—	0.2	—	—	—	—		

\* All valid input combinations.

961001EBA2'

- The products described in this document are subject to foreign exchange and foreign trade control laws.
- The information contained herein is presented only as a guide for the applications of our products. No responsibility is assumed by TOSHIBA CORPORATION for any infringements of intellectual property or other rights of the third parties which may result from its use. No license is granted by implication or otherwise under any intellectual property or other rights of TOSHIBA CORPORATION or others.
- The information contained herein is subject to change without notice.

**AC ELECTRICAL CHARACTERISTICS** (Ta = 25°C, CL = 50pF)

CHARACTERISTIC	SYMBOL	TEST CONDITION			MIN.	TYP.	MAX.	UNIT	
		VSS (V)	VEE (V)	VDD (V)					
Phase difference between input to output	φI-O	—	0	0	5	—	15	45	ns
			0	0	10	—	8	20	
			0	0	15	—	6	15	
Propagation Delay Time (A-OUT)	tpZL tpZH tpLZ tpHZ	RL = 1kΩ	0	0	5	—	170	550	ns
			0	0	10	—	90	240	
			0	0	15	—	70	160	
			0	-5	5	—	100	240	
			0	-7.5	7.5	—	80	160	
Propagation Delay Time (INH-OUT)	tpZL tpZH	RL = 1kΩ	0	0	5	—	120	380	ns
			0	0	10	—	60	200	
			0	0	15	—	50	160	
			0	-5	5	—	80	200	
			0	-7.5	7.5	—	60	160	
Propagation Delay Time (INH-OUT)	tpLZ tpHZ	RL = 1kΩ	0	0	5	—	170	450	ns
			0	0	10	—	90	210	
			0	0	15	—	70	160	
			0	-5	5	—	100	210	
			0	-7.5	7.5	—	80	160	
-3dB Cutoff Frequency	fMAX (I-O)	RL = 1kΩ (*1)	-5	-5	5	—	40	—	MHz
Total Harmonic Distortion	—	RL = 10kΩ f = 1kHz (*2)	-2.5	-2.5	2.5	—	0.15	—	%
			-5	-5	5	—	0.03	—	
			-7.5	-7.5	7.5	—	0.02	—	
-50dB Feedthrough (Switch OFF)	—	RL = 1kΩ (*3)	-5	-5	5	—	500	—	kHz
Crosstalk (CONTROL-OUT)	—	RIN = 1kΩ ROUT = 10kΩ CL = 15pF	0	0	5	—	200	—	mV
			0	0	10	—	400	—	
			0	0	15	—	600	—	

\*1 Sine wave of ±2.5Vp-p shall be used for V<sub>IS</sub> and the frequency of  $20\log_{10} \frac{V_{OS}}{V_{IS}}$  = -3dB shall be f<sub>MAX</sub>.

\*2 V<sub>IS</sub> shall be sine wave of  $\pm \left( \frac{V_{DD} - V_{EE}}{4} \right)$  p-p.

\*3 Sine wave of ±2.5Vp-p shall be used for V<sub>IS</sub> and the frequency of  $20\log_{10} \frac{V_{OS}}{V_{IS}}$  = -50dB shall be feed-through.

OUTLINE DRAWING  
SOP8-P-1.27

Unit : mm

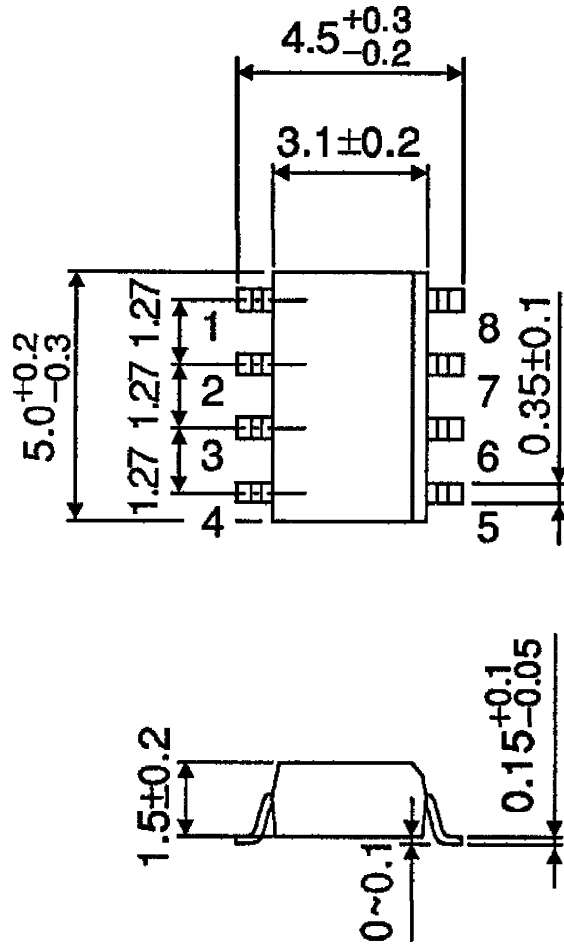

Weight : 0.05g (Typ.)

OUTLINE DRAWING  
SSOP8-P-0.65

Unit : mm

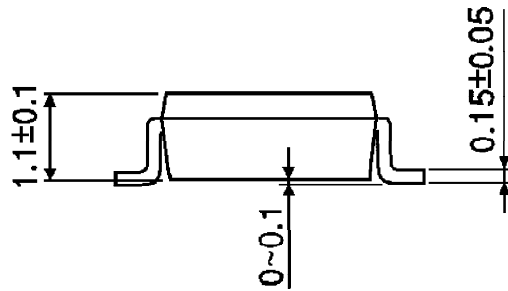
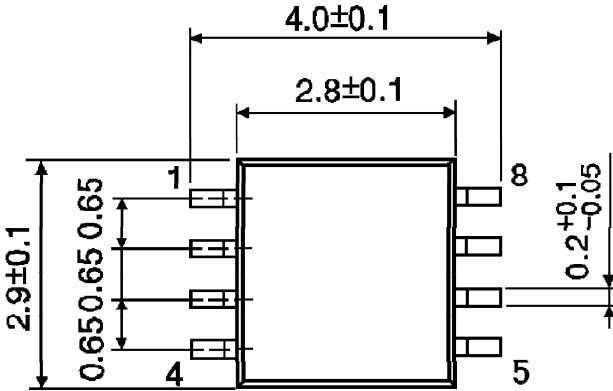

Weight : 0.02g (Typ.)