

# UDZ2.4B THRU UDZ36B

## List

List..... 1

Package outline..... 2

Features..... 2

Mechanical data..... 2

Maximum ratings ..... 2

Electrical characteristics..... 3

Rating and characteristic curves..... 4

Pinning information..... 5

Suggested solder pad layout..... 5

Packing information..... 6

Reel packing..... 7

Suggested thermal profiles for soldering processes..... 7

High reliability test capabilities..... 8

# UDZ2.4B THRU UDZ36B

## 200mW Surface Mount Zener Diodes - 2.4V-36V

### Features

- Silicon epitaxial planar chip structure
- Wide zener reverse voltage range 2.4V to 36V
- Very small package size for high density applications
- Ideally suited for automated assembly processes
- Lead-free parts meet RoHS requirements
- Suffix "-H" indicates Halogen-free part, ex.UDZ2.4B-H

### Mechanical data

- Epoxy:UL94-V0 rated flame retardant
- Case : Molded plastic, SOD-323F
- Terminals : Solder plated, solderable per MIL-STD-750, Method 2026
- Polarity : Indicated by cathode band
- Mounting Position : Any
- Weight : Approximated 0.005 gram

### Package outline

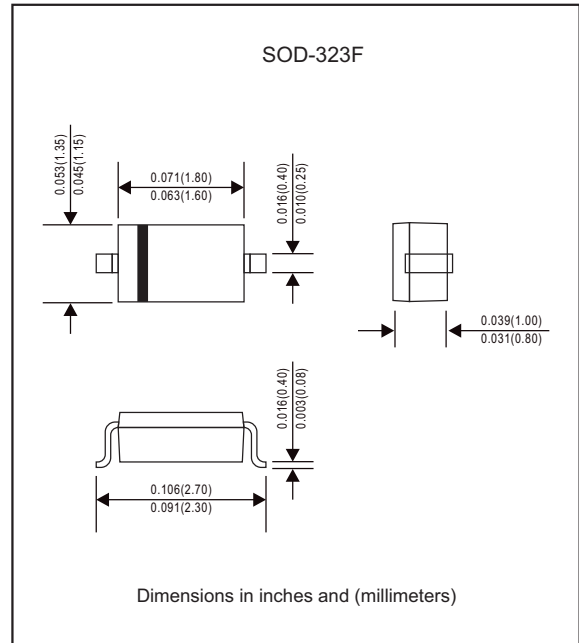

### Maximum ratings (at $T_A=25^\circ\text{C}$ unless otherwise noted)

Parameter	Symbol	MIN.	TYP.	MAX.	Unit
Power dissipation at $T_A=25^\circ\text{C}$	$P_D$			200	mW
Forward voltage at $I_F=10\text{mA}$	$V_F$			0.9	V
Thermal resistance from Junction to ambient	$R_{\theta JA}$		635		$^\circ\text{C/W}$
Junction to case	$R_{\theta JC}$		475		$^\circ\text{C/W}$
Junction temperature	$T_J$			+150	$^\circ\text{C}$
Storage temperature range	$T_{STG}$	-55		+150	$^\circ\text{C}$
Operating temperature range	$T_{OPR}$	-55		+150	$^\circ\text{C}$

## UDZ2.4B THRU UDZ36B

Electrical characteristics (at  $T_A=25^\circ\text{C}$  unless otherwise noted)

Part No.	Marking code	Zener voltage		Test current	Zener impedance			Leakage current	
		$V_Z @ I_{ZT}$		$I_{ZT}$	$Z_{ZT} @ I_{ZT}$	$Z_{ZK} @ I_{ZK}$	$I_{ZK}$	$I_R$	$V_R$
		Min.(V)	Max.(V)	mA	Max. ( $\Omega$ )	Max. ( $\Omega$ )	mA	Max. ( $\mu\text{A}$ )	Volts
UDZ2.4B	22	2.43	2.63	5	100	1000	0.5	100	1.0
UDZ2.7B	32	2.69	2.91	5	110	1000	0.5	100	1.0
UDZ3.0B	42	3.01	3.22	5	120	1000	0.5	50.0	1.0
UDZ3.3B	52	3.32	3.53	5	120	1000	0.5	20.0	1.0
UDZ3.6B	62	3.60	3.845	5	100	1000	1.0	10.0	1.0
UDZ3.9B	72	3.89	4.16	5	100	1000	1.0	5.0	1.0
UDZ4.3B	82	4.17	4.43	5	100	1000	1.0	5.0	1.0
UDZ4.7B	92	4.55	4.75	5	100	800	0.5	2.0	1.0
UDZ5.1B	A2	4.98	5.20	5	80	500	0.5	2.0	1.5
UDZ5.6B	C2	5.49	5.73	5	60	200	0.5	1.0	2.5
UDZ6.2B	E2	6.06	6.33	5	60	100	0.5	1.0	3.0
UDZ6.8B	F2	6.65	6.93	5	40	60	0.5	0.5	3.5
UDZ7.5B	H2	7.28	7.60	5	30	60	0.5	0.5	4.0
UDZ8.2B	J2	8.02	8.36	5	30	60	0.5	0.5	5.0
UDZ9.1B	L2	8.85	9.23	5	30	60	0.5	0.5	6.0
UDZ10B	05	9.77	10.21	5	30	60	0.5	0.1	7.0
UDZ11B	15	10.76	11.22	5	30	60	0.5	0.1	8.0
UDZ12B	25	11.74	12.24	5	30	80	0.5	0.1	9.0
UDZ13B	35	12.91	13.49	5	37	80	0.5	0.1	10.0
UDZ15B	45	14.34	14.98	5	42	80	0.5	0.1	11.0
UDZ16B	55	15.85	16.51	5	50	80	0.5	0.1	12.0
UDZ18B	65	17.56	18.35	5	65	80	0.5	0.1	13.0
UDZ20B	75	19.52	20.39	5	85	100	0.5	0.1	15.0
UDZ22B	85	21.54	22.47	5	100	100	0.5	0.1	17.0
UDZ24B	95	23.72	24.78	5	120	120	0.5	0.1	19.0
UDZ27B	A5	26.19	27.53	5	150	150	0.5	0.1	21.0
UDZ30B	C5	29.19	30.69	5	200	200	0.5	0.1	23.0
UDZ33B	E5	32.15	33.79	5	250	250	0.5	0.1	25.0
UDZ36B	F5	35.07	36.87	5	300	300	0.5	0.1	27.0

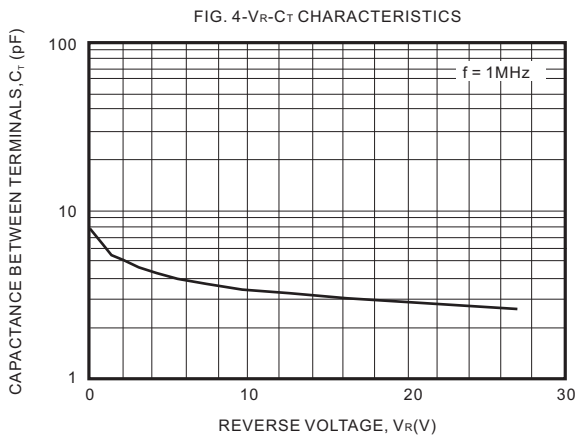
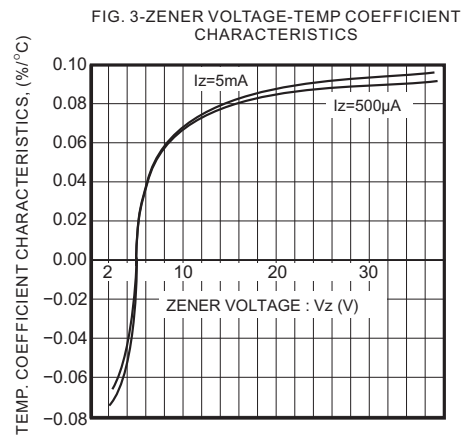
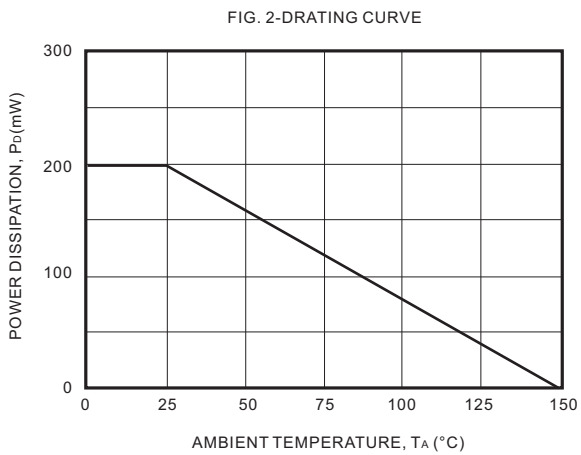
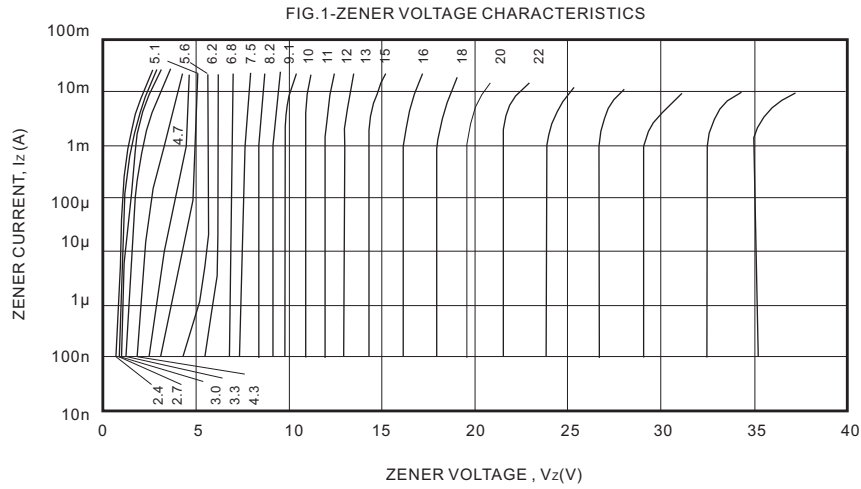

Notes 1. The Zener voltage( $V_Z$ ) is measured 40ms after power is supplied2. The operating resistances( $Z_{ZT}$ ,  $Z_{ZK}$ ) are measured by superimposing a minute alternating current on the regulated current( $I_{ZT}$ ,  $I_{ZK}$ )

## Rating and characteristic curves (UDZ2.4B THRU UDZ36B)



# UDZ2.4B THRU UDZ36B

## Pinning information

Pin	Simplified outline	Symbol
Pin1 cathode Pin2 anode		

## Suggested solder pad layout

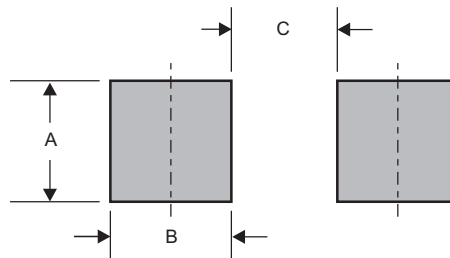

Dimensions in inches and (millimeters)

PACKAGE	A	B	C
SOD-323F	0.033 (0.83)	0.025 (0.63)	0.063 (1.60)

# UDZ2.4B THRU UDZ36B

## Packing information

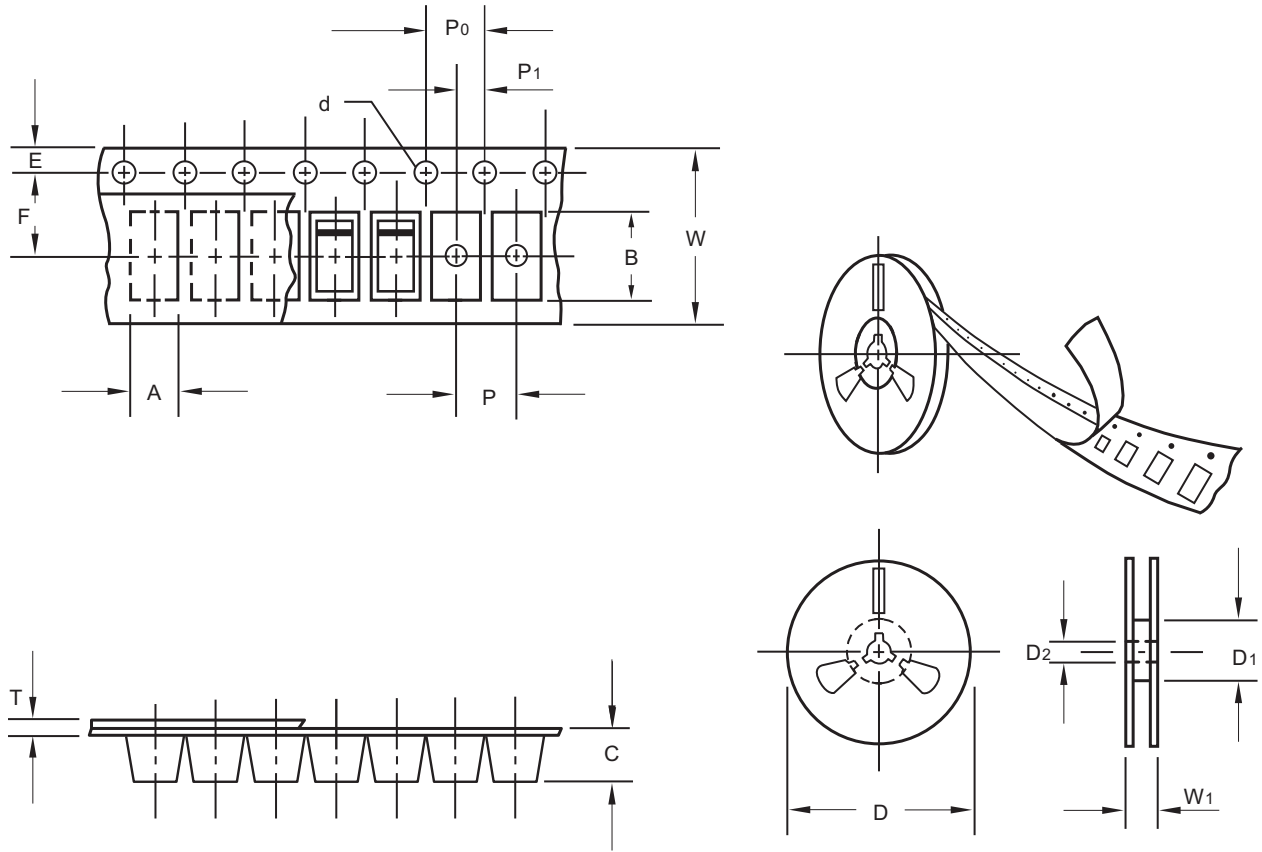

unit:mm

Item	Symbol	Tolerance	SOD-323F
Carrier width	A	0.1	1.46
Carrier length	B	0.1	2.95
Carrier depth	C	0.1	1.25
Sprocket hole	d	0.1	1.50
13" Reel outside diameter	D	2.0	-
13" Reel inner diameter	D1	min	-
7" Reel outside diameter	D	2.0	178.00
7" Reel inner diameter	D1	min	62.00
Feed hole diameter	D2	0.5	13.00
Sprocket hole position	E	0.1	1.75
Punch hole position	F	0.1	3.50
Punch hole pitch	P	0.1	4.00
Sprocket hole pitch	P0	0.1	4.00
Embossment center	P1	0.1	2.00
Overall tape thickness	T	0.1	0.23
Tape width	W	0.3	8.00
Reel width	W1	1.0	11.40

Note: Devices are packed in accordance with EIA standard RS-481-A and specifications listed above.

# UDZ2.4B THRU UDZ36B

## Reel packing

PACKAGE	REEL SIZE	REEL (pcs)	COMPONENT SPACING (m/m)	BOX (pcs)	INNER BOX (m/m)	REEL DIA, (m/m)	CARTON SIZE (m/m)	CARTON (pcs)	APPROX. GROSS WEIGHT (kg)
SOD-323F	7"	3,000	4.0	30,000	183*123*183	178	382*257*387	240,000	8.0

### Suggested thermal profiles for soldering processes

- 1.Storage environment: Temperature=5°C~40°C Humidity=55%±25%
- 2.Reflow soldering of surface-mount devices

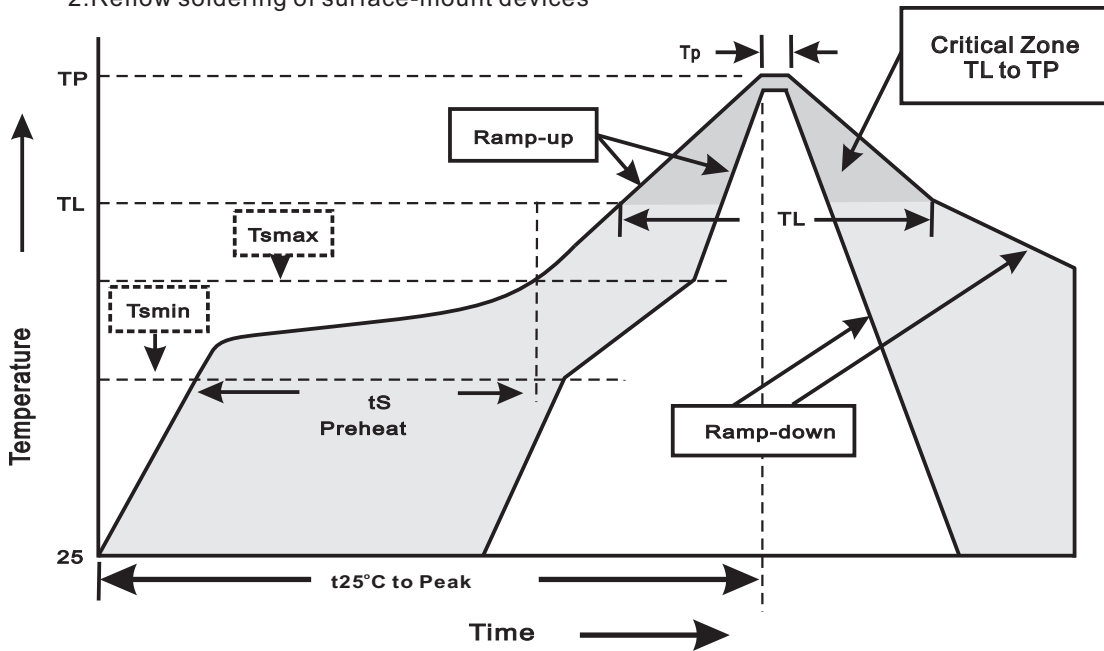

### 3.Reflow soldering

Profile Feature	Soldering Condition
Average ramp-up rate(TL to TP)	<3°C/sec
Preheat -Temperature Min(Tsmin) -Temperature Max(Tsmax) -Time(min to max)(ts)	150°C 200°C 60~120sec
Tsmax to TL -Ramp-upRate	<3°C/sec
Time maintained above: -Temperature(TL) -Time(tL)	217°C 60~260sec
Peak Temperature(TP)	255°C-0/+5°C
Time within 5°C of actual Peak Temperature(tp)	10~30sec
Ramp-down Rate	<6°C/sec
Time 25°C to Peak Temperature	<6minutes

# UDZ2.4B THRU UDZ36B

## High reliability test capabilities

Item Test	Conditions	Reference
1. Solder Resistance	at 260±5°C for 10±2sec.	MIL-STD-750D METHOD-2031
2. Solderability	at 245±5°C for 5 sec.	MIL-STD-202F METHOD-208
3. High Temperature Reverse Bias	V <sub>Z</sub> =V <sub>Z Min</sub> *80% at T <sub>J</sub> =150°C for 168 hrs.	MIL-STD-750D METHOD-1038
4. Pressure Cooker	15P <sub>SIG</sub> at T <sub>A</sub> =121°C for 4 hrs.	JESD22-A102
5. Temperature Cycling	-55°C to +125°C dwelled for 30 min. and transferred for 5min. total 10 cycles.	MIL-STD-750D METHOD-1051
6. Humidity	at T <sub>A</sub> =85°C, RH=85% for 1000hrs.	MIL-STD-750D METHOD-1021
7. High Temperature Storage Life	at 175°C for 1000 hrs.	MIL-STD-750D METHOD-1031